

**3.4.3 Number of patents/copyrights
published/awarded/technology-
transferred during the last five years
(10)**



**KRISHNA INSTITUTE OF MEDICAL SCIENCES
"DEEMED TO BE UNIVERSITY", KARAD**

Accredited by NAAC with 'A' Grade (CGPA: 3.20 on 4 Point Scale)
An ISO 9001:2015 Certified University

Declared U/s 3 of UGC ACT, 1956 vide Notification no.F.9-15/2001-U.3 of the Ministry of Human Resource
Development, Govt. of India

Karad, Dist : Satara (Maharashtra State) Pin : 415539
Website : www.kimskarad.in

Tel : 02164-241555-8 Fax: 02164-243273/242195
E-mail: research@kimskarad.in

CONSOLIDATED STATEMENT BY REGISTRAR, KIMSDU, KARAD

I, undersigned herewith certify that all documents of IPR like granted patent certificates, e-copies of the letters of patents, awarded design patents, patent publications, awarded copyright certificates and MoUs of technology-transferred documents are verified and authenticated.

Below mentioned table is enclosed herewith for the total of number of granted patents, designs, published patents, and awarded copyrights and technology-transferred as per requirement of 3.4.3 of the SSR booklet of NAAC.

Academic year	July 2015- June 2016	July 2016- June 2017	July 2017- June 2018	July 2018- June 2019	July 2019- Dec 2020	Total
Patent and Design Granted	0	0	5	2	16	23
Patent Published	0	2	2	5	26	35
Copyright Awarded	0	5	1	44	227	277
Technology-transfer	0	0	0	0	7	7
Total	0	7	8	51	276	342



Dr. M. V. Ghorpade
Registrar,
KIMSDU, Karad

Dr. D. K. Agarwal
Additional Director of Research,
KIMSDU, Karad



ORIGINAL

No. 60762

भारत सरकार
GOVERNMENT OF INDIA
पेटेंट कार्यालय
THE PATENT OFFICE

CERTIFICATE OF REGISTRATION OF DESIGN

Design No. 253320
Date 23/04/2013
Reciprocity Date*
Country

Certified that the design of which a copy is annexed hereto has been registered as of the number and date given above in class 24-02 in respect of the application of such design to FOOT LENGTH CALIPER in the name of KRISHNA INSTITUTE OF MEDICAL SCIENCES THROUGH DR. M. V. GHORPADE (REGISTRAR), NEAR DHEBEWADI ROAD, MALKAPUR, KARAD, MAHARASHTRA, INDIA

in pursuance of and subject to the provisions of the Designs Act, 2000 and the Designs Rules, 2001.

Controller General of Patents, Designs and Trade Marks

*The reciprocity date (if any) which has been allowed and the name of the country.
Copyright in the design will subsist for ten years from the date of Registration, and may under the terms of the Act and Rules, be extended for a further period of five years.
This Certificate is not for use in legal proceedings or for obtaining registration abroad

MRS. GAURI N. BHAVE,
"CHHAYA", PLOT NO. 42, SANGAM SOCIETY,
PADMAVATI, PUNE-SATARA ROAD, PUNE 411037,
MAHARASHTRA, INDIA

Date of Issue 22/12/2017 17:19:41



सत्यमेव जयते

ORIGINAL

No. 60763

भारत सरकार
GOVERNMENT OF INDIA
पेटेंट कार्यालय
THE PATENT OFFICE

CERTIFICATE OF REGISTRATION OF DESIGN

Design No. 253321
Date 23/04/2013
Reciprocity Date*
Country

Certified that the design of which a copy is annexed hereto has been registered as of the number and date given above in class 24-02 in respect of the application of such design to NAIL SHADE DEVICE FOR SCREENING OF ANEMIA in the name of KRISHNA INSTITUTE OF MEDICAL SCIENCES THROUGH DR. M. V. GHORPADE (REGISTRAR), NEAR DHEBEWADI ROAD, MALKAPUR, KARAD, MAHARASHTRA, INDIA

in pursuance of and subject to the provisions of the Designs Act, 2000 and the Designs Rules, 2001.

OK Sample

Controller General of Patents, Designs and Trade Marks

*The reciprocity date (if any) which has been allowed and the name of the country.
Copyright in the design will subsist for ten years from the date of Registration, and may under the terms of the Act and Rules, be extended for a further period of five years.
This Certificate is not for use in legal proceedings or for obtaining registration abroad

MRS. GAURI N. BHAVE,
"CHHAYA", PLOT NO. 42, SANGAM SOCIETY,
PADMAVATI, PUNE-SATARA ROAD, PUNE 411037,
MAHARASHTRA, INDIA

Date of Issue 22/12/2017 17:20:25

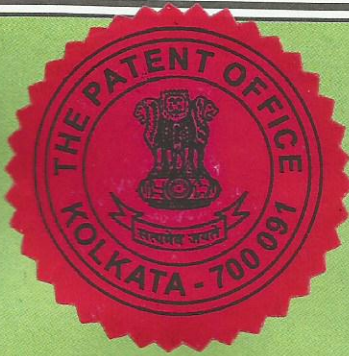

ORIGINAL

No. 60761

भारत सरकार
GOVERNMENT OF INDIA
पेटेंट कार्यालय
THE PATENT OFFICE

CERTIFICATE OF REGISTRATION OF DESIGN

Design No. 253322
Date 23/04/2013
Reciprocity Date*
Country

Certified that the design of which a copy is annexed hereto has been registered as of the number and date given above in class 09-03 in respect of the application of such design to CONTAINER in the name of KRISHNA INSTITUTE OF MEDICAL SCIENCES THROUGH DR. M. V. GHORPADE (REGISTRAR), NEAR DHEBEWADI ROAD, MALKAPUR, KARAD, MAHARASHTRA, INDIA

in pursuance of and subject to the provisions of the Designs Act, 2000 and the Designs Rules, 2001.

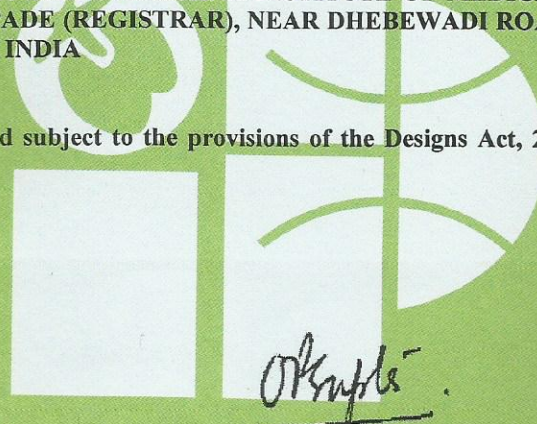

Oknpld

Controller General of Patents, Designs and Trade Marks

*The reciprocity date (if any) which has been allowed and the name of the country.
Copyright in the design will subsist for ten years from the date of Registration, and may under the terms of the Act and Rules, be extended for a further period of five years.
This Certificate is not for use in legal proceedings or for obtaining registration abroad

MRS. GAURI N. BHAVE,
"CHHAYA", PLOT NO. 42, SANGAM SOCIETY,
PADMAVATI, PUNE-SATARA ROAD, PUNE 411037,
MAHARASHTRA, INDIA

Date of Issue 22/12/2017 17:19:06



ORIGINAL

No. 60764

भारत सरकार
GOVERNMENT OF INDIA
पेटेंट कार्यालय
THE PATENT OFFICE

CERTIFICATE OF REGISTRATION OF DESIGN

Design No. 253323
Date 23/04/2013
Reciprocity Date*
Country

Certified that the design of which a copy is annexed hereto has been registered as of the number and date given above in class 24-02 in respect of the application of such design to MEDICAL AID USED FOR OBSTETRICIANS in the name of KRISHNA INSTITUTE OF MEDICAL SCIENCES THROUGH DR. M. V. GHORPADE (REGISTRAR), NEAR DHEBEWADI ROAD, MALKAPUR, KARAD, MAHARASHTRA, INDIA

in pursuance of and subject to the provisions of the Designs Act, 2000 and the Designs Rules, 2001.

Controller General of Patents, Designs and Trade Marks

*The reciprocity date (if any) which has been allowed and the name of the country.
Copyright in the design will subsist for ten years from the date of Registration, and may under the terms of the Act and Rules, be extended for a further period of five years.
This Certificate is not for use in legal proceedings or for obtaining registration abroad

MRS. GAURI N. BHAVE,
"CHHAYA", PLOT NO. 42, SANGAM SOCIETY,
PADMAVATI, PUNE-SATARA ROAD, PUNE 411037,
MAHARASHTRA, INDIA

Date of Issue 22/12/2017 17:20:56



ORIGINAL

No. 60858

भारत सरकार
GOVERNMENT OF INDIA
पेटेंट कार्यालय
THE PATENT OFFICE

CERTIFICATE OF REGISTRATION OF DESIGN

Design No. 253328
Date 23/04/2013
Reciprocity Date*
Country

Certified that the design of which a copy is annexed hereto has been registered as of the number and date given above in class 24-02 in respect of the application of such design to DENTAL IMPLEMENT in the name of KRISHNA INSTITUTE OF MEDICAL SCIENCES THROUGH DR. M. V. GHORPADE (REGISTRAR), NEAR DHEBEWADI ROAD, MALKAPUR, KARAD, MAHARASHTRA, INDIA

in pursuance of and subject to the provisions of the Designs Act, 2000 and the Designs Rules, 2001.

Controller General of Patents, Designs and Trade Marks

*The reciprocity date (if any) which has been allowed and the name of the country.

Copyright in the design will subsist for ten years from the date of Registration, and may under the terms of the Act and Rules, be extended for a further period of five years.

This Certificate is not for use in legal proceedings or for obtaining registration abroad

MRS. GAURI N. BHAVE,
"CHHAYA", PLOT NO. 42, SANGAM SOCIETY,
PADMAVATI, PUNE-SATARA ROAD, PUNE 411037,
MAHARASHTRA, INDIA

Date of Issue 26/12/2017 15:16:06



Controller General of Patents, Designs and Trademarks
Department of Industrial Policy and Promotion
Ministry of Commerce and Industry

Application Details

APPLICATION NUMBER	201721008360
APPLICATION TYPE	ORDINARY APPLICATION
DATE OF FILING	10/03/2017
APPLICANT NAME	KRISHNA INSTITUTE OF MEDICAL SCIENCES
TITLE OF INVENTION	PAA ARTICULATOR
FIELD OF INVENTION	BIO-MEDICAL ENGINEERING
E-MAIL (As Per Record)	advgnbhav@gmail.com
ADDITIONAL-EMAIL (As Per Record)	gauri@ipassist.in
E-MAIL (UPDATED Online)	
PRIORITY DATE	NA
REQUEST FOR EXAMINATION DATE	10/03/2017
PUBLICATION DATE (U/S 11A)	24/03/2017

Application Status

APPLICATION STATUS	Application Awaiting Examination
--------------------	---

[View Documents](#)



Controller General of Patents, Designs and Trademarks
Department of Industrial Policy and Promotion
Ministry of Commerce and Industry

Application Details

APPLICATION NUMBER	201621044526
APPLICATION TYPE	ORDINARY APPLICATION
DATE OF FILING	28/12/2016
APPLICANT NAME	KRISHNA INSTITUTE OF MEDICAL SCIENCES
TITLE OF INVENTION	KRISHNA INJECTION SYRINGE
FIELD OF INVENTION	BIO-MEDICAL ENGINEERING
E-MAIL (As Per Record)	advgnbhav@gmail.com
ADDITIONAL-EMAIL (As Per Record)	gauri@ipassist.in
E-MAIL (UPDATED Online)	
PRIORITY DATE	NA
REQUEST FOR EXAMINATION DATE	28/12/2016
PUBLICATION DATE (U/S 11A)	13/01/2017

Application Status

APPLICATION STATUS	Application Awaiting Examination
--------------------	---

[View Documents](#)

Dated : 05/06/2017

1. Registration Number : **L-66090/2017**
2. Name, address and nationality of the applicant : KRISHNA INSTITUTE OF MEDICAL SCIENCES DEEMED UNIVERSITY, THROUGH ITS REGISTRAR DR. M. V. GHORPADE, KRISHNA INSTITUTE OF MEDICAL SCIENCES DEEMED UNIVERSITY, NEAR DHEBEWADI ROAD, MALKAPUR TAL - KARAD. PIN - 415539 DIST. - SATARA, MAHARASHTRA, INDIA-415539
INDIAN
3. Nature of the applicant's interest in the copyright of the work : OWNER
4. Class and description of the work : LITERARY/ DRAMATIC WORK PATIENTS RISK FACTORS AND RESPONSE MEASURES THAT CAN BE USED EARLY DURING TREATMENT
5. Title of the work : FIELD LEVEL WORKER SCORING SYSTEM FOR TUBERCULOSIS TREATMENT OUTCOMES
6. Language of the work : ENGLISH
7. Name, address and nationality of the author and if the author is deceased, date of his decease : DR. ASHA PRATINIDHI, DIRECTOR OF RESEARCH, KRISHNA INSTITUTE OF MEDICAL SCIENCES DEEMED UNIVERSITY, NEAR DHEBEWADI ROAD, MALKAPUR TAL - KARAD. PIN - 415539 DIST. - SATARA, MAHARASHTRA, INDIA-415539
INDIAN
DR. SWAPNIL LALE, DISTRICT TUBERCULOSIS OFFICER SATARA, DIST-SATARA, MAHARASHTRA, INDIA-415539
INDIAN
DR. GERALD QUINNAN, PUBLIC HEALTH CONSULTANT, KRISHNA INSTITUTE OF MEDICAL SCIENCES DEEMED UNIVERSITY, NEAR DHEBEWADI ROAD, MALKAPUR TAL - KARAD. PIN - 415539 DIST. - SATARA, MAHARASHTRA, INDIA-415539
INDIAN
DR. SWATI AUNDHKAR, PROFESSOR & HEAD, DEPARTMENT OF MEDICINE, KRISHNA INSTITUTE OF MEDICAL SCIENCES DEEMED UNIVERSITY, NEAR DHEBEWADI ROAD, MALKAPUR TAL - KARAD. PIN - 415539 DIST. - SATARA, MAHARASHTRA, INDIA-415539
INDIAN
DR. A. C. BOTRE, ASSISTANT PROFESSOR, KRISHNA INSTITUTE OF MEDICAL SCIENCES DEEMED UNIVERSITY, NEAR DHEBEWADI ROAD, MALKAPUR TAL - KARAD. PIN - 415539 DIST. - SATARA, MAHARASHTRA, INDIA-415539
INDIAN
DR. A. V. JADHAV, MEDICAL OFFICER, DISTRICT TUBERCULOSIS CENTER SATARA, DIST- SATARA, MAHARASHTRA-415539
INDIAN
DR. K. D. DAYAL, MEDICAL OFFICER, DISTRICT TUBERCULOSIS CENTER SATARA, DIST- SATARA, MAHARASHTRA, INDIA-415539
INDIAN
8. Whether the work is published or unpublished : UNPUBLISHED
9. Year and country of first publication and name, address and nationality of the publisher : N.A.
10. Years and countries of subsequent publications, if any, and names, addresses and nationalities of the publishers : N.A.
11. Names, addresses and nationalities of the owners of various rights comprising the copyright in the work and the extent of rights held by each, together with particulars of assignments and licences, if any : KRISHNA INSTITUTE OF MEDICAL SCIENCES DEEMED UNIVERSITY, THROUGH ITS REGISTRAR DR. M. V. GHORPADE, KRISHNA INSTITUTE OF MEDICAL SCIENCES DEEMED UNIVERSITY, NEAR DHEBEWADI ROAD, MALKAPUR TAL - KARAD. PIN - 415539 DIST. - SATARA, MAHARASHTRA, INDIA-415539
INDIAN
12. Names, addresses and nationalities of other persons, if any, authorised to assign or licence of rights comprising the copyright : KRISHNA INSTITUTE OF MEDICAL SCIENCES DEEMED UNIVERSITY, THROUGH ITS REGISTRAR DR. M. V. GHORPADE, KRISHNA INSTITUTE OF MEDICAL SCIENCES DEEMED UNIVERSITY, NEAR DHEBEWADI ROAD, MALKAPUR TAL - KARAD. PIN - 415539 DIST. - SATARA, MAHARASHTRA, INDIA-415539
INDIAN
13. If the work is an 'Artistic work', the location of the original work, including name, address and nationality of the person in possession of the work. (In the case of an architectural work, the year of completion of the work should also be shown). : N.A.
14. If the work is an 'Artistic work', whether it is registered under the Designs Act 2000 if yes give details. : N.A.
15. If the work is an 'Artistic work', capable of being registered as a design under the Designs Act 2000 whether it has been applied to an : N.A.

Dated : 05/06/2017

1. Registration Number : **L-66076/2017**
2. Name, address and nationality of the applicant : KRISHNA INSTITUTE OF MEDICAL SCIENCES DEEMED UNIVERSITY, THROUGH ITS REGISTRAR DR. M. V. GHORPADE, KRISHNA INSTITUTE OF MEDICAL SCIENCES DEEMED UNIVERSITY, NEAR DHEBEWADI ROAD, MALKAPUR TAL - KARAD. PIN - 415539 DIST. - SATARA, MAHARASHTRA, INDIA-415539
INDIAN
3. Nature of the applicant's interest in the copyright of the work : OWNER
4. Class and description of the work : LITERARY/ DRAMATIC WORK SCREENING AID THE ADULT AND CHILDHOOD CONTACTS CAN BE SCREENED FOR SYMPTOMATIC SUSPECTED CASES OF T.B. BY THE HEALTH VISITORS
5. Title of the work : TUBERCULOSIS CONTACT TRACING PICTORIAL CARD
6. Language of the work : ENGLISH
7. Name, address and nationality of the author and if the author is deceased, date of his decease : DR. ASHA PRATINIDHI, DIRECTOR OF RESEARCH, KRISHNA INSTITUTE OF MEDICAL SCIENCES DEEMED UNIVERSITY, NEAR DHEBEWADI ROAD, MALKAPUR TAL - KARAD. PIN - 415539 DIST. - SATARA, MAHARASHTRA, INDIA-415539
INDIAN
DR. SWAPNIL LALE, DISTRICT TUBERCULOSIS OFFICER SATARA, DIST- SATARA, MAHARASHTRA, INDIA-415539
INDIAN
DR. GERALD QUINNAN, PUBLIC HEALTH CONSULTANT, KRISHNA INSTITUTE OF MEDICAL SCIENCES DEEMED UNIVERSITY, NEAR DHEBEWADI ROAD, MALKAPUR TAL - KARAD. PIN - 415539 DIST. - SATARA, MAHARASHTRA, INDIA-415539
INDIAN
DR. P. M. DURGAWALE, PROFESSOR & HEAD DEPARTMENT OF COMMUNITY MEDICINE, KRISHNA INSTITUTE OF MEDICAL SCIENCES DEEMED UNIVERSITY, NEAR DHEBEWADI ROAD, MALKAPUR TAL - KARAD. PIN - 415539 DIST. - SATARA, MAHARASHTRA, INDIA-415539
INDIAN
DR. V. V. RAJE, PROFESSOR, DEPARTMENT OF COMMUNITY MEDICINE, KRISHNA INSTITUTE OF MEDICAL SCIENCES DEEMED UNIVERSITY, NEAR DHEBEWADI ROAD, MALKAPUR TAL - KARAD. PIN - 415539 DIST. - SATARA, MAHARASHTRA, INDIA-415539
INDIAN
DR. A. V. JADHAV, MEDICAL OFFICER, DISTRICT TUBERCULOSIS CENTER SATARA, DIST- SATARA, MAHARASHTRA, INDIA-415539
INDIAN
DR. K. D. DAYAL, MEDICAL OFFICER, DISTRICT TUBERCULOSIS CENTER SATARA, DIST- SATARA, MAHARASHTRA, INDIA-415539
INDIAN
DR. MRS. NEELIMA A. MALIK, EX- PRINCIPAL, SCHOOL OF DENTAL SCIENCE, KRISHNA INSTITUTE OF MEDICAL SCIENCES DEEMED UNIVERSITY, NEAR DHEBEWADI ROAD, MALKAPUR TAL - KARAD. PIN - 415539 DIST. - SATARA, MAHARASHTRA, INDIA-415539
INDIAN
8. Whether the work is published or unpublished : UNPUBLISHED
9. Year and country of first publication and name, address and nationality of the publisher : N.A.
10. Years and countries of subsequent publications, if any, and names, addresses and nationalities of the publishers : N.A.
11. Names, addresses and nationalities of the owners of various rights comprising the copyright in the work and the extent of rights held by each, together with particulars of assignments and licences, if any : KRISHNA INSTITUTE OF MEDICAL SCIENCES DEEMED UNIVERSITY, THROUGH ITS REGISTRAR DR. M. V. GHORPADE, KRISHNA INSTITUTE OF MEDICAL SCIENCES DEEMED UNIVERSITY, NEAR DHEBEWADI ROAD, MALKAPUR TAL - KARAD. PIN - 415539 DIST. - SATARA, MAHARASHTRA, INDIA-415539
INDIAN
12. Names, addresses and nationalities of other persons, if any, authorised to assign or licence of rights comprising the copyright : KRISHNA INSTITUTE OF MEDICAL SCIENCES DEEMED UNIVERSITY, THROUGH ITS REGISTRAR DR. M. V. GHORPADE, KRISHNA INSTITUTE OF MEDICAL SCIENCES DEEMED UNIVERSITY, NEAR DHEBEWADI ROAD, MALKAPUR TAL - KARAD. PIN - 415539 DIST. - SATARA, MAHARASHTRA, INDIA-415539
INDIAN
13. If the work is an 'Artistic work', the location of the original work, including name, address and nationality of the person in possession of the work. (In the case of an architectural work, the year of completion of the work should also be shown) : N.A.

Dated : 05/06/2017

1. Registration Number : **L-66085/2017**
2. Name, address and nationality of the applicant : KRISHNA INSTITUTE OF MEDICAL SCIENCES DEEMED UNIVERSITY, THROUGH ITS REGISTRAR DR. M. V. GHORPADE , KRISHNA INSTITUTE OF MEDICAL SCIENCES DEEMED UNIVERSITY, NEAR DHEBEWADI ROAD, MALKAPUR TAL - KARAD. PIN - 415539 DIST. - SATARA, MAHARASHTRA, INDIA-415539
INDIAN
3. Nature of the applicant's interest in the copyright of the work : OWNER
4. Class and description of the work : LITERARY/ DRAMATIC WORK BOOK ON QUALITY AND PROCEDURES GUIDELINES
5. Title of the work : KRISHNA HOSPITAL - BLOOD BANK HANDBOOK
6. Language of the work : ENGLISH
7. Name, address and nationality of the author and if the author is deceased, date of his decease : DR. MRS. SUREKHA CHAVAN; M.D. MICROBIOLOGY - BLOOD TRANSFUSION OFFICER , KRISHNA INSTITUTE OF MEDICAL SCIENCES DEEMED UNIVERSITY, NEAR DHEBEWADI ROAD, MALKAPUR TAL - KARAD. PIN - 415539 DIST. - SATARA, MAHARASHTRA, INDIA-415539-415539
INDIAN
DR. ASHOK KSHIRSAGAR; MASTER OF SURGERY - MEDICAL DIRECTOR , KRISHNA INSTITUTE OF MEDICAL SCIENCES DEEMED UNIVERSITY, NEAR DHEBEWADI ROAD, MALKAPUR TAL - KARAD. PIN - 415539 DIST. - SATARA, MAHARASHTRA, INDIA-415539-415539
INDIAN
8. Whether the work is published or unpublished : UNPUBLISHED
9. Year and country of first publication and name, address and nationality of the publisher : N.A.
10. Years and countries of subsequent publications, if any, and names, addresses and nationalities of the publishers : N.A.
11. Names, addresses and nationalities of the owners of various rights comprising the copyright in the work and the extent of rights held by each, together with particulars of assignments and licences, if any : KRISHNA INSTITUTE OF MEDICAL SCIENCES DEEMED UNIVERSITY, THROUGH ITS REGISTRAR DR. M. V. GHORPADE , KRISHNA INSTITUTE OF MEDICAL SCIENCES DEEMED UNIVERSITY, NEAR DHEBEWADI ROAD, MALKAPUR TAL - KARAD. PIN - 415539 DIST. - SATARA, MAHARASHTRA, INDIA-415539
INDIAN
12. Names, addresses and nationalities of other persons, if any, authorised to assign or licence of rights comprising the copyright : KRISHNA INSTITUTE OF MEDICAL SCIENCES DEEMED UNIVERSITY, THROUGH ITS REGISTRAR DR. M. V. GHORPADE , KRISHNA INSTITUTE OF MEDICAL SCIENCES DEEMED UNIVERSITY, NEAR DHEBEWADI ROAD, MALKAPUR TAL - KARAD. PIN - 415539 DIST. - SATARA, MAHARASHTRA, INDIA-415539
INDIAN
13. If the work is an 'Artistic work', the location of the original work, including name, address and nationality of the person in possession of the work. (In the case of an architectural work, the year of completion of the work should also be shown). : N.A.
14. If the work is an 'Artistic work', whether it is registered : N.A.

Dated : 05/06/2017

- L-66086/2017**
1. Registration Number
 2. Name, address and nationality of the applicant : KRISHNA INSTITUTE OF MEDICAL SCIENCES DEEMED UNIVERSITY, THROUGH ITS REGISTRAR DR. M. V. GHORPADE, KRISHNA INSTITUTE OF MEDICAL SCIENCES DEEMED UNIVERSITY, NEAR DHEBEWADI ROAD, MALKAPUR TAL - KARAD. PIN - 415539 DIST. - SATARA, MAHARASHTRA, INDIA-415539
INDIAN
 3. Nature of the applicant's interest in the copyright of the work : OWNER
 4. Class and description of the work : LITERARY/ DRAMATIC WORK BOOK ON QUALITY AND PROCEDURES GUIDELINES
 5. Title of the work : KRISHNA HOSPITAL - SAFETY HANDBOOK
 6. Language of the work : ENGLISH
 7. Name, address and nationality of the author and if the author is deceased, date of his decease : DR. ASHOK KSHIRSAGAR; MASTER OF SURGERY; MEDICAL DIRECTOR, KRISHNA INSTITUTE OF MEDICAL SCIENCES DEEMED UNIVERSITY, NEAR DHEBEWADI ROAD, MALKAPUR TAL - KARAD. PIN - 415539 DIST. - SATARA, MAHARASHTRA, INDIA-415539-415539
INDIAN
MR. SATYANARAYAN MASHALKAR; M.A.; DME; SAFETY OFFICER, KRISHNA INSTITUTE OF MEDICAL SCIENCES DEEMED UNIVERSITY, NEAR DHEBEWADI ROAD, MALKAPUR TAL - KARAD. PIN - 415539 DIST. - SATARA, MAHARASHTRA, INDIA-415539-415539
INDIAN
DR. SATISH PATIL; M.D. MICROBIOLOGY; QUALITY MANAGER, KRISHNA INSTITUTE OF MEDICAL SCIENCES DEEMED UNIVERSITY, NEAR DHEBEWADI ROAD, MALKAPUR TAL - KARAD. PIN - 415539 DIST. - SATARA, MAHARASHTRA, INDIA-415539-415539
INDIAN
MR. TUSHAR KADAM; PGDHHM; MBA; OFFICE SUPERINTENDENT, KRISHNA INSTITUTE OF MEDICAL SCIENCES DEEMED UNIVERSITY, NEAR DHEBEWADI ROAD, MALKAPUR TAL - KARAD. PIN - 415539 DIST. - SATARA, MAHARASHTRA, INDIA-415539-415539
INDIAN
MRS. KAVITA KAPURKAR; M.SC. NURSING; QUALITY COORDINATOR, KRISHNA INSTITUTE OF MEDICAL SCIENCES DEEMED UNIVERSITY, NEAR DHEBEWADI ROAD, MALKAPUR TAL - KARAD. PIN - 415539 DIST. - SATARA, MAHARASHTRA, INDIA-415539-415539
INDIAN
MRS. SANDHYA JAGDALE; M.SC. NURSING; QUALITY COORDINATOR, KRISHNA INSTITUTE OF MEDICAL SCIENCES DEEMED UNIVERSITY, NEAR DHEBEWADI ROAD, MALKAPUR TAL - KARAD. PIN - 415539 DIST. - SATARA, MAHARASHTRA, INDIA-415539-415539
INDIAN
MRS. ROHINI BABAR; M.SC. NURSING; QUALITY COORDINATOR, KRISHNA INSTITUTE OF MEDICAL SCIENCES DEEMED UNIVERSITY, NEAR DHEBEWADI ROAD, MALKAPUR TAL - KARAD. PIN - 415539 DIST. - SATARA, MAHARASHTRA, INDIA-415539-415539
INDIAN
 8. Whether the work is published or unpublished : UNPUBLISHED
 9. Year and country of first publication and name, address and nationality of the publisher : N.A.
 10. Years and countries of subsequent publications, if any, and names, addresses and nationalities of the publishers : N.A.
 11. Names, addresses and nationalities of the owners of various rights comprising the copyright in the work and the extent of rights held by each, together with particulars of assignments and licences, if any : KRISHNA INSTITUTE OF MEDICAL SCIENCES DEEMED UNIVERSITY, THROUGH ITS REGISTRAR DR. M. V. GHORPADE, KRISHNA INSTITUTE OF MEDICAL SCIENCES DEEMED UNIVERSITY, NEAR DHEBEWADI ROAD, MALKAPUR TAL - KARAD. PIN - 415539 DIST. - SATARA, MAHARASHTRA, INDIA-415539
INDIAN
 12. Names, addresses and nationalities of other persons, if any, authorised to assign or licence of rights comprising the copyright : KRISHNA INSTITUTE OF MEDICAL SCIENCES DEEMED UNIVERSITY, THROUGH ITS REGISTRAR DR. M. V. GHORPADE, KRISHNA INSTITUTE OF MEDICAL SCIENCES DEEMED UNIVERSITY, NEAR DHEBEWADI ROAD, MALKAPUR TAL - KARAD. PIN - 415539 DIST. - SATARA, MAHARASHTRA, INDIA-415539
INDIAN
 13. If the work is an 'Artistic work', the location of the original work, including name, address and nationality of the person in possession of the work. (In the case of an architectural work, the year of completion of the work should also be shown). : N.A.

Dated : 08/06/2017

1. Registration Number : **L-66290/2017**
2. Name, address and nationality of the applicant : KRISHNA INSTITUTE OF MEDICAL SCIENCES DEEMED UNIVERSITY, THROUGH ITS REGISTRAR DR. M. V. GHORPADE , KRISHNA INSTITUTE OF MEDICAL SCIENCES DEEMED UNIVERSITY, NEAR DHEBEWADI ROAD, MALKAPUR TAL - KARAD. PIN - 415539 DIST. - SATARA, MAHARASHTRA, INDIA-415539
INDIAN
3. Nature of the applicant's interest in the copyright of the work : OWNER
4. Class and description of the work : LITERARY/ DRAMATIC WORK BOOK ON QUALITY AND PROCEDURES GUIDELINES
5. Title of the work : KRISHNA HOSPITAL - QUALITY HANDBOOK
6. Language of the work : ENGLISH
7. Name, address and nationality of the author and if the author is deceased, date of his decease : DR. ASHOK KSHIRSAGAR; MASTER OF SURGERY; MEDICAL DIRECTOR , KRISHNA INSTITUTE OF MEDICAL SCIENCES DEEMED UNIVERSITY, NEAR DHEBEWADI ROAD, MALKAPUR TAL - KARAD. PIN - 415539 DIST. - SATARA, MAHARASHTRA, INDIA-415539-415539
INDIAN
DR. SATISH PATIL; M.D. MICROBIOLOGY; QUALITY MANAGER , KRISHNA INSTITUTE OF MEDICAL SCIENCES DEEMED UNIVERSITY, NEAR DHEBEWADI ROAD, MALKAPUR TAL - KARAD. PIN - 415539 DIST. - SATARA, MAHARASHTRA, INDIA-415539-415539
INDIAN
MR. TUSHAR KADAM; PGDHHM; MBA; OFFICE SUPERINTENDENT , KRISHNA INSTITUTE OF MEDICAL SCIENCES DEEMED UNIVERSITY, NEAR DHEBEWADI ROAD, MALKAPUR TAL - KARAD. PIN - 415539 DIST. - SATARA, MAHARASHTRA, INDIA-415539-415539
INDIAN
MRS. KAVITA KAPURKAR;M.SC. NURSING; QUALITY COORDINATOR , KRISHNA INSTITUTE OF MEDICAL SCIENCES DEEMED UNIVERSITY, NEAR DHEBEWADI ROAD, MALKAPUR TAL - KARAD. PIN - 415539 DIST. - SATARA, MAHARASHTRA, INDIA-415539-415539
INDIAN
MRS. SANDHYA JAGDALE; M.SC. NURSING; QUALITY COORDINATOR , KRISHNA INSTITUTE OF MEDICAL SCIENCES DEEMED UNIVERSITY, NEAR DHEBEWADI ROAD, MALKAPUR TAL - KARAD. PIN - 415539 DIST. - SATARA, MAHARASHTRA, INDIA-415539-415539
INDIAN
MRS. ROHINI BABAR;M.SC. NURSING; QUALITY COORDINATOR , KRISHNA INSTITUTE OF MEDICAL SCIENCES DEEMED UNIVERSITY, NEAR DHEBEWADI ROAD, MALKAPUR TAL - KARAD. PIN - 415539 DIST. - SATARA, MAHARASHTRA, INDIA-415539-415539
INDIAN



Controller General of Patents, Designs and Trademarks
Department of Industrial Policy and Promotion
Ministry of Commerce and Industry

Application Details

APPLICATION NUMBER	201623023433
APPLICATION TYPE	PATENT OF ADDITION FOR ORDINARY APPLICATION
DATE OF FILING	08/07/2016
APPLICANT NAME	1 . Indian Institute of Technology, Bombay 2 . Krishna Institute of Medical Sciences 3 . Department of Biotechnology
TITLE OF INVENTION	BIOARTIFICIAL PANCREAS
FIELD OF INVENTION	MECHANICAL ENGINEERING
E-MAIL (As Per Record)	patent@depenning.com
ADDITIONAL-EMAIL (As Per Record)	patent@depenning.com
E-MAIL (UPDATED Online)	
PARENT APPLICATION NUMBER	2697/MUM/2010
PRIORITY DATE	NA
REQUEST FOR EXAMINATION DATE	08/07/2016
PUBLICATION DATE (U/S 11A)	12/01/2018

Application Status

APPLICATION STATUS	Application Awaiting Examination
--------------------	---

[View Documents](#)



Controller General of Patents, Designs and Trademarks
Department of Industrial Policy and Promotion
Ministry of Commerce and Industry

Application Details

APPLICATION NUMBER	201821000542
APPLICATION TYPE	ORDINARY APPLICATION
DATE OF FILING	05/01/2018
APPLICANT NAME	KRISHNA INSTITUTE OF MEDICAL SCIENCES DEEMED UNIVERSITY
TITLE OF INVENTION	KRISHNA GONIOMETER, LIMB LENGTH AND LIMB GIRTH COMBO
FIELD OF INVENTION	BIO-MEDICAL ENGINEERING
E-MAIL (As Per Record)	advgnbhav@gmail.com
ADDITIONAL-EMAIL (As Per Record)	gauri@ipassist.in
E-MAIL (UPDATED Online)	
PRIORITY DATE	NA
REQUEST FOR EXAMINATION DATE	05/01/2018
PUBLICATION DATE (U/S 11A)	12/01/2018

Application Status

APPLICATION STATUS	Application Awaiting Examination
--------------------	---

[View Documents](#)



Controller General of Patents, Designs and Trademarks
Department of Industrial Policy and Promotion
Ministry of Commerce and Industry

Application Details

APPLICATION NUMBER	201821045967
APPLICATION TYPE	ORDINARY APPLICATION
DATE OF FILING	05/12/2018
APPLICANT NAME	KRISHNA INSTITUTE OF MEDICAL SCIENCES DEEMED TO BE UNIVERSITY
TITLE OF INVENTION	VISI PAP FLASK
FIELD OF INVENTION	BIO-MEDICAL ENGINEERING
E-MAIL (As Per Record)	advgnbhav@gmail.com
ADDITIONAL-EMAIL (As Per Record)	gauri@ipassist.in
E-MAIL (UPDATED Online)	
PRIORITY DATE	NA
REQUEST FOR EXAMINATION DATE	05/12/2018
PUBLICATION DATE (U/S 11A)	07/12/2018

Application Status

APPLICATION STATUS	Application Awaiting Examination
--------------------	---

[View Documents](#)



Controller General of Patents, Designs and Trademarks
Department of Industrial Policy and Promotion
Ministry of Commerce and Industry

Application Details

APPLICATION NUMBER	201821031869
APPLICATION TYPE	ORDINARY APPLICATION
DATE OF FILING	25/08/2018
APPLICANT NAME	SUNITA HOSHEDAR TATA
TITLE OF INVENTION	"A DEVICE FOR PHYSICALLY RESTRAINING MOVEMENT"
FIELD OF INVENTION	POLYMER TECHNOLOGY
E-MAIL (As Per Record)	mailbox@lexregia.in
ADDITIONAL-EMAIL (As Per Record)	royak777@gmail.com
E-MAIL (UPDATED Online)	
PRIORITY DATE	NA
REQUEST FOR EXAMINATION DATE	30/11/2018
PUBLICATION DATE (U/S 11A)	07/09/2018
FIRST EXAMINATION REPORT DATE	11/12/2018
Date Of Certificate Issue	09/04/2019
POST GRANT JOURNAL DATE	12/04/2019
REPLY TO FER DATE	22/12/2018

Application Status

APPLICATION STATUS	Granted Application, Patent Number :311016
--------------------	---

[E-Register](#)
[Order\(s\)/Decision\(s\)](#)
[View Documents](#)



Controller General of Patents, Designs and Trademarks
Department of Industrial Policy and Promotion
Ministry of Commerce and Industry

Application Details

APPLICATION NUMBER	201821031870
APPLICATION TYPE	ORDINARY APPLICATION
DATE OF FILING	25/08/2018
APPLICANT NAME	RAJASHRI BHAGWAT KARALE
TITLE OF INVENTION	"AN INJECTION GUIDE"
FIELD OF INVENTION	BIO-MEDICAL ENGINEERING
E-MAIL (As Per Record)	mailbox@lexregia.in
ADDITIONAL-EMAIL (As Per Record)	royak777@gmail.com
E-MAIL (UPDATED Online)	
PRIORITY DATE	NA
REQUEST FOR EXAMINATION DATE	30/11/2018
PUBLICATION DATE (U/S 11A)	07/09/2018
FIRST EXAMINATION REPORT DATE	17/12/2018
Date Of Certificate Issue	21/06/2019
POST GRANT JOURNAL DATE	28/06/2019
REPLY TO FER DATE	22/12/2018

Application Status

APPLICATION STATUS	Granted Application, Patent Number :314417
--------------------	---

[E-Register](#)
[Order\(s\)/Decision\(s\)](#)
[View Documents](#)

Dated : 13/06/2018

1. Registration Number : **L-75989/2018**
2. Name, address and nationality of the applicant : KRISHNA INSTITUTE OF MEDICAL SCIENCES "DEEMED TO BE UNIVERSITY" , KRISHNA INSTITUTE OF MEDICAL SCIENCES "DEEMED TO BE UNIVERSITY", NEAR DHEBEWADI ROAD, MALKAPUR TAL - KARAD, DIST. - SATARA, MAHARASHTRA, INDIA-415539
INDIAN
3. Nature of the applicant's interest in the copyright of the work : OWNER
4. Class and description of the work : LITERARY/  DRAMATIC WORK
5. Title of the work : COMBINED GLIDING MOBILIZATION
6. Language of the work : ENGLISH
7. Name, address and nationality of the author and if the author is deceased, date of his decease : DR. G VARADHARAJULU , KRISHNA INSTITUTE OF MEDICAL SCIENCES "DEEMED TO BE UNIVERSITY", NEAR DHEBEWADI ROAD, MALKAPUR TAL - KARAD, DIST. - SATARA, MAHARASHTRA, INDIA-415539
INDIAN
8. Whether the work is published or unpublished : UNPUBLISHED
9. Year and country of first publication and name, address and nationality of the publisher : N.A.
10. Years and countries of subsequent publications, if any, and names, addresses and nationalities of the publishers : N.A.
11. Names, addresses and nationalities of the owners of various rights comprising the copyright in the work and the extent of rights held by each, together with particulars of assignments and licences, if any : KRISHNA INSTITUTE OF MEDICAL SCIENCES "DEEMED TO BE UNIVERSITY" , KRISHNA INSTITUTE OF MEDICAL SCIENCES "DEEMED TO BE UNIVERSITY", NEAR DHEBEWADI ROAD, MALKAPUR TAL - KARAD, DIST. - SATARA, MAHARASHTRA, INDIA-415539
INDIAN
12. Names, addresses and nationalities of other persons, if any, authorised to assign or licence of rights comprising the copyright : KRISHNA INSTITUTE OF MEDICAL SCIENCES "DEEMED TO BE UNIVERSITY" , KRISHNA INSTITUTE OF MEDICAL SCIENCES "DEEMED TO BE UNIVERSITY", NEAR DHEBEWADI ROAD, MALKAPUR TAL - KARAD, DIST. - SATARA, MAHARASHTRA, INDIA-415539
INDIAN
13. If the work is an 'Artistic work', the location of the original work, including name, address and nationality of the person in possession of the work. (In the case of an architectural work, the year of completion of the work should also be shown). : N.A.
14. If the work is an 'Artistic work', whether it is registered under the Designs Act 2000 if yes give details. : N.A.
15. If the work is an 'Artistic work', capable of being registered as a design under the Designs Act 2000 whether it has been applied to an article though an industrial process and ,if yes ,the number of times it is reproduced. : N.A.



Extracts from the Register of Copyrights

Dated : 23/07/2018

1. Registration Number : **L-76759/2018**
2. Name, address and nationality of the applicant : KRISHNA INSTITUTE OF MEDICAL SCIENCES "DEEMED TO BE UNIVERSITY" THROUGH REGISTRAR DR. M.V.GHORPADE , KRISHNA INSTITUTE OF MEDICAL SCIENCES "DEEMED TO BE UNIVERSITY", NEAR DHEBEWADI ROAD, MALKAPUR TAL - KARAD, PIN - 415539 DIST. - SATARA, MAHARASHTRA, INDIA-415539 INDIAN
3. Nature of the applicant's interest in the copyright of the work : OWNER
4. Class and description of the work : LITERARY/ DRAMATIC WORK
5. Title of the work : BASIC CONCEPTS OF NURSING FOUNDATION
6. Language of the work : ENGLISH
7. Name, address and nationality of the author and if the author is deceased, date of his decease : DR. A.Y.KSHIRSAGAR , MEDICAL DIRECTOR, KRISHNA HOSPITAL & MEDICAL RESEARCH CENTRE, NEAR DHEBEWADI ROAD, MALKAPUR TAL - KARAD. PIN - 415539 DIST. - SATARA, MAHARASHTRA, INDIA.-415539 INDIAN
MR. TUSHAR KADAM , OFFICE SUPERINTENDENT, KRISHNA HOSPITAL & MEDICAL RESEARCH CENTRE, NEAR DHEBEWADI ROAD, MALKAPUR TAL - KARAD. PIN - 415539 DIST. - SATARA, MAHARASHTRA, INDIA.-415539 INDIAN
MRS.SANDHYA ANIL JAGDALE , ASSISTING NURSING SUPERINTENDENT / QUALITY CO-ORDINATOR, KRISHNA HOSPITAL & MEDICAL RESEARCH CENTRE, NEAR DHEBEWADI ROAD, MALKAPUR TAL - KARAD. PIN - 415539 DIST. - SATARA, MAHARASHTRA, INDIA ASSISTI-415539 INDIAN
MRS.KAVITA SANJAY KAPURKAR , ASSISTING NURSING SUPERINTENDENT / QUALITY CO-ORDINATOR, KRISHNA HOSPITAL & MEDICAL RESEARCH CENTRE, NEAR DHEBEWADI ROAD, MALKAPUR TAL - KARAD. PIN - 415539 DIST. - SATARA, MAHARASHTRA, INDIA-415539 INDIAN
MRS. ROHINI VIMLAKAR BABAR , NURSING SUPERINTENDENT / QUALITY CO-ORDINATOR, KRISHNA HOSPITAL & MEDICAL RESEARCH CENTRE, NEAR DHEBEWADI ROAD, MALKAPUR TAL - KARAD. PIN - 415539 DIST. - SATARA, MAHARASHTRA, INDIA.-415539 INDIAN
8. Whether the work is published or unpublished : UNPUBLISHED
9. Year and country of first publication and name, address and nationality of the publisher : N.A.
10. Years and countries of subsequent publications, if any, and names, addresses and nationalities of the publishers : N.A.
11. Names, addresses and nationalities of the owners of various rights comprising the copyright in the work and the extent of rights held by each, together with particulars of assignments and licences, if any : KRISHNA INSTITUTE OF MEDICAL SCIENCES "DEEMED TO BE UNIVERSITY" THROUGH REGISTRAR DR. M.V.GHORPADE , KRISHNA INSTITUTE OF MEDICAL SCIENCES "DEEMED TO BE UNIVERSITY", NEAR DHEBEWADI ROAD, MALKAPUR TAL - KARAD, PIN - 415539 DIST. - SATARA, MAHARASHTRA, INDIA-415539 INDIAN
12. Names, addresses and nationalities of other persons, if any, authorised to assign or licence of rights comprising the copyright : KRISHNA INSTITUTE OF MEDICAL SCIENCES "DEEMED TO BE UNIVERSITY" THROUGH REGISTRAR DR. M.V.GHORPADE , KRISHNA INSTITUTE OF MEDICAL SCIENCES "DEEMED TO BE UNIVERSITY", NEAR DHEBEWADI ROAD, MALKAPUR TAL - KARAD, PIN - 415539 DIST. - SATARA, MAHARASHTRA, INDIA-415539 INDIAN
13. If the work is an 'Artistic work', the location of the original work, including name, address and nationality of the person in possession of the work. (In the case of an architectural work, the year of completion of the work should also be shown). : N.A.
14. If the work is an 'Artistic work', whether it is registered under the : N.A.

Dated : 03/08/2018

1. Registration Number : **L-77044/2018**
2. Name, address and nationality of the applicant : KRISHNA INSTITUTE OF MEDICAL SCIENCES "DEEMED TO BE UNIVERSITY" THROUGH REGISTRAR DR. M.V.GHORPADE , KRISHNA INSTITUTE OF MEDICAL SCIENCES "DEEMED TO BE UNIVERSITY", NEAR DHEBEWADI ROAD, MALKAPUR TAL - KARAD. PIN - 415539 DIST. - SATARA, MAHARASHTRA, INDIA-415539 INDIAN
3. Nature of the applicant's interest in the copyright of the work : OWNER
4. Class and description of the work : LITERARY/ DRAMATIC WORK
5. Title of the work : NURSING HAND BOOK OF INTENSIVE CARE
6. Language of the work : ENGLISH
7. Name, address and nationality of the author and if the author is deceased, date of his decease : DR. A.Y.KSHIRSAGAR , MEDICAL DIRECTOR, KRISHNA HOSPITAL & MEDICAL RESEARCH CENTRE, NEAR DHEBEWADI ROAD, MALKAPUR TAL - KARAD. PIN - 415539 DIST. - SATARA, MAHARASHTRA, INDIA-415539 INDIAN
MRS. ROHINI VIMLAKAR BABAR , NURSING SUPERINTENDENT / QUALITY CO-COORDINATOR, KRISHNA HOSPITAL & MEDICAL RESEARCH CENTRE, NEAR DHEBEWADI ROAD, MALKAPUR TAL - KARAD. PIN - 415539 DIST. - SATARA, MAHARASHTRA, INDIA-415539 INDIAN
MR. TUSHAR KADAM , OFFICE SUPERINTENDENT, KRISHNA HOSPITAL & MEDICAL RESEARCH CENTRE, NEAR DHEBEWADI ROAD, MALKAPUR TAL - KARAD. PIN - 415539 DIST. - SATARA, MAHARASHTRA, INDIA.-415539 INDIAN
MRS.SANDHYA ANIL JAGADALE , ASSISTING NURSING SUPERINTENDENT / QUALITY CO-COORDINATOR, KRISHNA HOSPITAL & MEDICAL RESEARCH CENTRE, NEAR DHEBEWADI ROAD, MALKAPUR TAL - KARAD. PIN - 415539 DIST. - SATARA, MAHARASHTRA, INDIA-415539 INDIAN
MRS.KAVITA SANJAY KAPURKAR , ASSISTING NURSING SUPERINTENDENT / QUALITY CO-COORDINATOR, KRISHNA HOSPITAL & MEDICAL RESEARCH CENTRE, NEAR DHEBEWADI ROAD, MALKAPUR TAL - KARAD. PIN - 415539 DIST. - SATARA, MAHARASHTRA, INDIA-415539 INDIAN
8. Whether the work is published or unpublished : UNPUBLISHED
9. Year and country of first publication and name, address and nationality of the publisher : N.A.
10. Years and countries of subsequent publications, if any, and names, addresses and nationalities of the publishers : N.A.
11. Names, addresses and nationalities of the owners of various rights comprising the copyright in the work and the extent of rights held by each, together with particulars of assignments and licences, if any : KRISHNA INSTITUTE OF MEDICAL SCIENCES "DEEMED TO BE UNIVERSITY" THROUGH REGISTRAR DR. M.V.GHORPADE , KRISHNA INSTITUTE OF MEDICAL SCIENCES "DEEMED TO BE UNIVERSITY", NEAR DHEBEWADI ROAD, MALKAPUR TAL - KARAD. PIN - 415539 DIST. - SATARA, MAHARASHTRA, INDIA-415539 INDIAN
12. Names, addresses and nationalities of other persons, if any, authorised to assign or licence of rights comprising the copyright : KRISHNA INSTITUTE OF MEDICAL SCIENCES "DEEMED TO BE UNIVERSITY" THROUGH REGISTRAR DR. M.V.GHORPADE , KRISHNA INSTITUTE OF MEDICAL SCIENCES "DEEMED TO BE UNIVERSITY", NEAR DHEBEWADI ROAD, MALKAPUR TAL - KARAD. PIN - 415539 DIST. - SATARA, MAHARASHTRA, INDIA-415539 INDIAN
13. If the work is an 'Artistic work', the location of the original work, including name, address and nationality of the person in possession of the work. (In the case of an architectural work, the year of completion of the work should also be shown). : N.A.

Dated : 14/09/2018

1. Registration Number : **L-77849/2018**
 2. Name, address and nationality of the applicant : DR. NEELIMA A. MALIK , VICE-CHANCELLOR, KRISHNA INSTITUTE OF MEDICAL SCIENCE DEEMED UNIVERSITY, KARAD, MALKAPUR, TAL. KARAD, DIST. SATARA-415539 INDIAN
 3. Nature of the applicant's interest in the copyright of the work : OWNER
 4. Class and description of the work : LITERARY/ DRAMATIC WORK
 5. Title of the work : BLOOMING BEAUTY: ADOLESCENT GIRLS' HEALTH CLINIC
 6. Language of the work : ENGLISH
 7. Name, address and nationality of the author and if the author is deceased, date of his decease : DR. SUPRIYA PATIL , PROFESSOR, DEPT. OF COMMUNITY MEDICINE, KRISHNA INSTITUTE OF MEDICAL SCIENCE TO BE DEEMED UNIVERSITY, KARAD, MALKAPUR, TAL. KARAD, DIST. SATARA-415539 INDIAN
DR. NEELIMA A. MALIK , VICE-CHANCELLOR, KRISHNA INSTITUTE OF MEDICAL SCIENCE TO BE DEEMED UNIVERSITY, KARAD, MALKAPUR, TAL. KARAD, DIST. SATARA-415539 INDIAN
 8. Whether the work is published or unpublished : UNPUBLISHED
 9. Year and country of first publication and name, address and nationality of the publisher : N.A.
 10. Years and countries of subsequent publications, if any, and names, addresses and nationalities of the publishers : N.A.
 11. Names, addresses and nationalities of the owners of various rights comprising the copyright in the work and the extent of rights held by each, together with particulars of assignments and licences, if any : DR. NEELIMA A. MALIK , VICE-CHANCELLOR, KRISHNA INSTITUTE OF MEDICAL SCIENCE DEEMED UNIVERSITY, KARAD, MALKAPUR, TAL. KARAD, DIST. SATARA-415539 INDIAN
 12. Names, addresses and nationalities of other persons, if any, authorised to assign or licence of rights comprising the copyright : N.A.
 13. If the work is an 'Artistic work', the location of the original work, including name, address and nationality of the person in possession of the work. (In the case of an architectural work, the year of completion of the work should also be shown). : N.A.
 14. If the work is an 'Artistic work', whether it is registered under the Designs Act 2000 if yes give details. : N.A.
 15. If the work is an 'Artistic work', capable of being registered as a design under the Designs Act 2000, whether it has been applied to an article through an industrial process and, if yes, the number of times it is reproduced. : N.A.
 16. Remarks, if any :
- Diary Number : 2751/2018-CO/L
Date of Application : 22/02/2018
Date of Receipt : 22/02/2018

उप पंजीयन अधिकारी प्रतिलिप्याधिकार
Deputy Registrar of Copyright

DEPUTY REGISTRAR OF COPYRIGHTS

Dated : 20/09/2018

1. Registration Number : **L-77949/2018**
2. Name, address and nationality of the applicant : KRISHNA INSTITUTE OF MEDICAL SCIENCES "DEEMED TO BE UNIVERSITY", KARAD , KRISHNA INSTITUTE OF MEDICAL SCIENCES "DEEMED TO BE UNIVERSITY", KARAD MALKAPUR, KARAD, DIST. SATARA, MAHARASHTRA, INDIA-415539
INDIAN
3. Nature of the applicant's interest in the copyright of the work : OWNER
4. Class and description of the work : LITERARY/ DRAMATIC WORK
5. Title of the work : KNEE TRACTION FRAME
6. Language of the work : ENGLISH
7. Name, address and nationality of the author and if the author is deceased, date of his decease : DR. VAISHALI JAGTAP , KRISHNA INSTITUTE OF MEDICAL SCIENCES DEEMED TO BE UNIVERSITY, KARAD, MALKAPUR, KARAD, DIST. SATARA, MAHARASHTRA-415539
INDIAN
8. Whether the work is published or unpublished : UNPUBLISHED
9. Year and country of first publication and name, address and nationality of the publisher : N.A.
10. Years and countries of subsequent publications, if any, and names, addresses and nationalities of the publishers : N.A.
11. Names, addresses and nationalities of the owners of various rights comprising the copyright in the work and the extent of rights held by each, together with particulars of assignments and licences, if any : KRISHNA INSTITUTE OF MEDICAL SCIENCES "DEEMED TO BE UNIVERSITY", KARAD , KRISHNA INSTITUTE OF MEDICAL SCIENCES "DEEMED TO BE UNIVERSITY", KARAD MALKAPUR, KARAD, DIST. SATARA, MAHARASHTRA, INDIA-415539
INDIAN
DR. VAISHALI JAGTAP , KRISHNA INSTITUTE OF MEDICAL SCIENCES DEEMED TO BE UNIVERSITY, KARAD, MALKAPUR, KARAD, DIST. SATARA, MAHARASHTRA-415539
INDIAN
12. Names, addresses and nationalities of other persons, if any, authorised to assign or licence of rights comprising the copyright : N.A.
13. If the work is an 'Artistic work', the location of the original work, including name, address and nationality of the person in possession of the work. (In the case of an architectural work, the year of completion of the work should also be shown). : N.A.
14. If the work is an 'Artistic work', whether it is registered under the Designs Act 2000 if yes give details. : N.A.

Dated : 20/09/2018

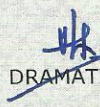
1. Registration Number : **L-77950/2018**
2. Name, address and nationality of the applicant : KRISHNA INSTITUTE OF MEDICAL SCIENCES DEEMED TO BE UNIVERSITY, KARAD , KRISHNA INSTITUTE OF MEDICAL SCIENCES DEEMED TO BE UNIVERSITY, KARAD MALKAPUR, KARAD, DIST. SATARA, MAHARASHTRA-415539
INDIAN
3. Nature of the applicant's interest in the copyright of the work : OWNER
4. Class and description of the work : LITERARY/  DRAMATIC WORK
5. Title of the work : GONIOMETER, LIMB LENGTH AND LIMB GIRTH COMBO
6. Language of the work : ENGLISH
7. Name, address and nationality of the author and if the author is deceased, date of his decease : DR. VAISHALI JAGTAP , KRISHNA INSTITUTE OF MEDICAL SCIENCES DEEMED TO BE UNIVERSITY, KARAD MALKAPUR, KARAD, DIST. SATARA, MAHARASHTRA-415539
INDIAN
8. Whether the work is published or unpublished : UNPUBLISHED
9. Year and country of first publication and name, address and nationality of the publisher : N.A.
10. Years and countries of subsequent publications, if any, and names, addresses and nationalities of the publishers : N.A.
11. Names, addresses and nationalities of the owners of various rights comprising the copyright in the work and the extent of rights held by each, together with particulars of assignments and licences, if any : KRISHNA INSTITUTE OF MEDICAL SCIENCES DEEMED TO BE UNIVERSITY, KARAD , KRISHNA INSTITUTE OF MEDICAL SCIENCES DEEMED TO BE UNIVERSITY, KARAD MALKAPUR, KARAD, DIST. SATARA, MAHARASHTRA-415539
INDIAN
DR. VAISHALI JAGTAP , KRISHNA INSTITUTE OF MEDICAL SCIENCES DEEMED TO BE UNIVERSITY, KARAD MALKAPUR, KARAD, DIST. SATARA, MAHARASHTRA-415539
INDIAN
12. Names, addresses and nationalities of other persons, if any, authorised to assign or licence of rights comprising the copyright : N.A.
13. If the work is an 'Artistic work', the location of the original work, including name, address and nationality of the person in possession of the work. (In the case of an architectural work, the year of completion of the work should also be shown). : N.A.
14. If the work is an 'Artistic work', whether it is registered under the Designs Act 2000 if yes give details. : N.A.
15. If the work is an 'Artistic work', capable of being registered as a design under the Designs Act 2000 whether it has been applied to an article through : N.A.

Dated : 24/09/2018

1. Registration Number : **L-77979/2018**
2. Name, address and nationality of the applicant : KRISHNA INSTITUTE OF MEDICAL SCIENCES "DEEMED TO BE UNIVERSITY" THROUGH REGISTRAR DR. M.V.GHORPADE , KRISHNA INSTITUTE OF MEDICAL SCIENCES "DEEMED TO BE UNIVERSITY", NEAR DHEBEWADI ROAD, MALKAPUR TAL - KARAD. PIN - 415539 DIST. - SATARA, MAHARASHTRA, INDIA-415539 INDIAN
3. Nature of the applicant's interest in the copyright of the work : OWNER 
4. Class and description of the work : LITERARY/ DRAMATIC WORK
5. Title of the work : MANUAL OF OPERATION THEATER TECHNIQUE
6. Language of the work : ENGLISH
7. Name, address and nationality of the author and if the author is deceased, date of his decease : 3. MRS.KAVITA SANJAY KAPURKAR , ASSISTING NURSING SUPERINTENDENT / QUALITY CO-ORDINATOR, KRISHNA HOSPITAL & MEDICAL RESEARCH CENTRE, NEAR DHEBEWADI ROAD, MALKAPUR TAL - KARAD, PIN - 415539 DIST. - SATARA, MAHARASHTRA, INDIA-415539 INDIAN
2. MR. TUSHAR KADAM , OFFICE SUPERINTENDENT KRISHNA HOSPITAL & MEDICAL RESEARCH CENTRE, NEAR DHEBEWADI ROAD, MALKAPUR TAL - KARAD, PIN - 415539 DIST. - SATARA, MAHARASHTRA, INDIA-415539 INDIAN
4. MRS.SANDHYA ANIL JAGADALE , ASSISTING NURSING SUPERINTENDENT / QUALITY CO-ORDINATOR, KRISHNA HOSPITAL & MEDICAL RESEARCH CENTRE, NEAR DHEBEWADI ROAD, MALKAPUR TAL - KARAD, PIN - 415539 DIST. - SATARA, MAHARASHTRA, INDIA-415539 INDIAN
1. MRS. ROHINI VIMLAKAR BABAR , NURSING SUPERINTENDENT / QUALITY CO-COORDINATOR, KRISHNA HOSPITAL & MEDICAL RESEARCH CENTRE, NEAR DHEBEWADI ROAD, MALKAPUR TAL - KARAD, PIN - 415539 DIST. - SATARA, MAHARASHTRA, INDIA-415539 INDIAN
5. DR. A.Y.KSHIRSAGAR , MEDICAL DIRECTOR, KRISHNA HOSPITAL & MEDICAL RESEARCH CENTRE, NEAR DHEBEWADI ROAD, MALKAPUR TAL - KARAD, PIN - 415539 DIST. - SATARA, MAHARASHTRA, INDIA-415539 INDIAN
8. Whether the work is published or unpublished : UNPUBLISHED
9. Year and country of first publication and name, address and nationality of the publisher : N.A.
10. Years and countries of subsequent publications, if any, and names, addresses and nationalities of the publishers : N.A.
11. Names, addresses and nationalities of the owners of various rights comprising the copyright in the work and the extent of rights held by each, together with particulars of assignments and licences, if any : KRISHNA INSTITUTE OF MEDICAL SCIENCES "DEEMED TO BE UNIVERSITY" THROUGH REGISTRAR DR. M.V.GHORPADE , KRISHNA INSTITUTE OF MEDICAL SCIENCES "DEEMED TO BE UNIVERSITY", NEAR DHEBEWADI ROAD, MALKAPUR TAL - KARAD. PIN - 415539 DIST. - SATARA, MAHARASHTRA, INDIA-415539 INDIAN
12. Names, addresses and nationalities of other persons, if any, authorised to assign or licence of rights comprising the copyright : KRISHNA INSTITUTE OF MEDICAL SCIENCES "DEEMED TO BE UNIVERSITY" THROUGH REGISTRAR DR. M.V.GHORPADE , KRISHNA INSTITUTE OF MEDICAL SCIENCES "DEEMED TO BE UNIVERSITY", NEAR DHEBEWADI ROAD, MALKAPUR TAL - KARAD. PIN - 415539 DIST. - SATARA, MAHARASHTRA, INDIA-415539 INDIAN
13. If the work is an 'Artistic work', the location of the original work, including name, address and nationality of the person in possession of the work. (In the case of an architectural work, the year of completion of the work should also be shown). : N.A.
14. If the work is an 'Artistic work', whether it is registered under the Designs Act 2000 if yes give details. : N.A.
15. If the work is an 'Artistic work', capable of being registered as a design under the Designs Act 2000.whether it has been applied to an article though an industrial process and if yes the number of times it is : N.A.

Dated : 25/09/2018

1. Registration Number : **L-77997/2018**
2. Name, address and nationality of the applicant : KRISHNA INSTITUTE OF MEDICAL SCIENCES DEEMED TO BE UNIVERSITY, KARAD , KRISHNA INSTITUTE OF MEDICAL SCIENCES DEEMED TO BE UNIVERSITY, KARAD, MALKAPUR, KARAD, DIST. SATARA, MAHARASHTRA-415539
INDIAN
3. Nature of the applicant's interest in the copyright of the work : OWNER
4. Class and description of the work : LITERARY/  DRAMATIC WORK
5. Title of the work : WAX BALL TECHNIQUE
6. Language of the work : ENGLISH
7. Name, address and nationality of the author and if the author is deceased, date of his decease : DR. SUSHMA R. , FACULTY OF DENTAL SCIENCES, KRISHNA INSTITUTE OF MEDICAL SCIENCES DEEMED UNIVERSITY NEAR DHEBEWADI ROAD, MALKAPUR, TALUKA- KARAD, DIST- SATARA-415110
INDIAN
8. Whether the work is published or unpublished : UNPUBLISHED
9. Year and country of first publication and name, address and nationality of the publisher : N.A.
10. Years and countries of subsequent publications, if any, and names, addresses and nationalities of the publishers : N.A.
11. Names, addresses and nationalities of the owners of various rights comprising the copyright in the work and the extent of rights held by each, together with particulars of assignments and licences, if any : KRISHNA INSTITUTE OF MEDICAL SCIENCES DEEMED TO BE UNIVERSITY, KARAD , KRISHNA INSTITUTE OF MEDICAL SCIENCES DEEMED TO BE UNIVERSITY, KARAD, MALKAPUR, KARAD, DIST. SATARA, MAHARASHTRA-415539
INDIAN
12. Names, addresses and nationalities of other persons, if any, authorised to assign or licence of rights comprising the copyright : N.A.
13. If the work is an 'Artistic work', the location of the original work, including name, address and nationality of the person in possession of the work. (In the case of an architectural work, the year of completion of the work should also be shown). : N.A.
14. If the work is an 'Artistic work', whether it is registered under the Designs Act 2000 if yes give details. : N.A.
15. If the work is an 'Artistic work', capable of being registered as a design under the Designs Act 2000. whether it has been applied to an article through an industrial process and ,if yes ,the number of times it is reproduced. : N.A.

Dated : 26/09/2018

1. Registration Number : **L-78006/2018**
2. Name, address and nationality of the applicant : KRISHNA INSTITUTE OF MEDICAL SCIENCES DEEMED TO BE UNIVERSITY, KARAD , KRISHNA INSTITUTE OF MEDICAL SCIENCES DEEMED TO BE UNIVERSITY, KARAD, MALKAPUR, KARAD, DIST. SATARA, MAHARASHTRA-415539 INDIAN
3. Nature of the applicant's interest in the copyright of the work : OWNER
4. Class and description of the work : LITERARY/ ^{DR}DRAMATIC WORK
5. Title of the work : DENTURE BASED DESIGN FOR THE WAX BALL TECHNIQUE
6. Language of the work : ENGLISH
7. Name, address and nationality of the author and if the author is deceased, date of his decease : DR. SUSHMA 'R. , FACULTY OF DENTAL SCIENCES, KRISHNA INSTITUTE OF MEDICAL SCIENCES DEEMED TO BE UNIVERSITY NEAR DHEBEWADI ROAD, MALKAPUR, TALUKA-KARAD, DIST- SATARA-415110 INDIAN
8. Whether the work is published or unpublished : UNPUBLISHED
9. Year and country of first publication and name, address and nationality of the publisher : N.A.
10. Years and countries of subsequent publications, if any, and names, addresses and nationalities of the publishers : N.A.
11. Names, addresses and nationalities of the owners of various rights comprising the copyright in the work and the extent of rights held by each, together with particulars of assignments and licences, if any : KRISHNA INSTITUTE OF MEDICAL SCIENCES DEEMED TO BE UNIVERSITY, KARAD , KRISHNA INSTITUTE OF MEDICAL SCIENCES DEEMED TO BE UNIVERSITY, KARAD, MALKAPUR, KARAD, DIST. SATARA, MAHARASHTRA-415539 INDIAN
12. Names, addresses and nationalities of other persons, if any, authorised to assign or licence of rights comprising the copyright : N.A.
13. If the work is an 'Artistic work', the location of the original work, including name, address and nationality of the person in possession of the work. (In the case of an architectural work, the year of completion of the work should also be shown). : N.A.
14. If the work is an 'Artistic work', whether it is registered under the Designs Act 2000 if yes give details. : N.A.
15. If the work is an 'Artistic work', capable of being registered as a design under the Designs Act 2000. whether it has been applied to an article though an industrial process and ,if yes ,the number of times it is reproduced. : N.A.

Dated : 29/11/2018

1. Registration Number : **L-79135/2018**
2. Name, address and nationality of the applicant : KRISHNA INSTITUTE OF MEDICAL SCIENCES "DEEMED TO BE UNIVERSITY", KARAD , KRISHNA INSTITUTE OF MEDICAL SCIENCES "DEEMED TO BE UNIVERSITY", KARAD, MALKAPUR, KARAD, DIST. SATARA, MAHARASHTRA, INDIA-415539
INDIAN
3. Nature of the applicant's interest in the copyright of the work : OWNER
4. Class and description of the work : LITERARY/ DRAMATIC WORK
5. Title of the work : SCORING SYSTEM FOR IDENTIFICATION OF 'AT RISK' MOTHERS LIKELY TO GIVE BIRTH TO LOW BIRTH WEIGHT
6. Language of the work : ENGLISH
7. Name, address and nationality of the author and if the author is deceased, date of his decease : DR. JYOTI AVINASH SALUNKHE , PROFESSOR ; KRISHNA INSTITUTE OF NURSING SCIENCES; KRISHNA INSTITUTE OF MEDICAL SCIENCES, DEEMED TO BE UNIVERSITY KARAD, MAHARASHTRA.-415539
INDIAN

DR.ASHA PRATINIDHI , PROFESSOR, EMERITUS; DEPARTMENT OF COMMUNITY MEDICINE, KRISHNA INSTITUTE OF MEDICAL SCIENCES, DEEMED TO BE UNIVERSITY KARAD, MAHARASHTRA-415539
INDIAN

MR. AVINASH H. SALUNKHE , PROFESSOR , & VICE PRINCIPAL KRISHNA INSTITUTE OF NURSING SCIENCES; KRISHNA INSTITUTE OF MEDICAL SCIENCES, DEEMED TO BE UNIVERSITY KARAD, MAHARASHTRA.-415539
INDIAN

DR. SATISH V. KAKADE , PROFESSOR ; KRISHNA INSTITUTE OF MEDICAL SCIENCES; KARAD ; DEPARTMENT OF COMMUNITY MEDICINE; KRISHNA INSTITUTE OF MEDICAL SCIENCES DEEMED TO BE UNIVERSITY, KARAD, MAHARASHTRA, INDIA.-415539
INDIAN
8. Whether the work is published or unpublished : UNPUBLISHED
9. Year and country of first publication and name, address and nationality of the publisher : N.A.
10. Years and countries of subsequent publications, if any, and names, addresses and nationalities of the publishers : N.A.
11. Names, addresses and nationalities of the owners of various rights comprising the copyright in the work and the extent of rights held by each, together with particulars of assignments and licences, if any : KRISHNA INSTITUTE OF MEDICAL SCIENCES "DEEMED TO BE UNIVERSITY", KARAD , KRISHNA INSTITUTE OF MEDICAL SCIENCES "DEEMED TO BE UNIVERSITY", KARAD, MALKAPUR, KARAD, DIST. SATARA, MAHARASHTRA, INDIA-415539
INDIAN
12. Names, addresses and nationalities of other persons, if any, authorised to assign or licence of rights comprising the copyright : N.A.
13. If the work is an 'Artistic work', the location of the original work, including name, address and nationality of the person in possession of the work. (In the case of an architectural work, the year of completion of the work should also be shown). : N.A.
14. If the work is an 'Artistic work', whether it is registered under the Designs Act 2000 if yes give details. : N.A.
15. If the work is an 'Artistic work', capable of being registered as a design under the Designs Act 2000 whether it has been : N.A.

Dated : 29/11/2018

1. Registration Number : **L-79137/2018**
2. Name, address and nationality of the applicant : KRISHNA INSTITUTE OF MEDICAL SCIENCES "DEEMED TO BE UNIVERSITY", KARAD , KRISHNA INSTITUTE OF MEDICAL SCIENCES "DEEMED TO BE UNIVERSITY", KARAD, MALKAPUR, KARAD, DIST. SATARA, MAHARASHTRA, INDIA-415539
INDIAN
3. Nature of the applicant's interest in the copyright of the work : OWNER 
4. Class and description of the work : LITERARY/ DRAMATIC WORK
5. Title of the work : SCORING SYSTEM FOR IDENTIFICATION OF 'AT RISK' MOTHERS LIKELY TO GIVE BIRTH TO PRETERM BIRTHS
6. Language of the work : ENGLISH
7. Name, address and nationality of the author and if the author is deceased, date of his decease : DR. JYOTI AVINASH SALUNKHE , PROFESSOR ; KRISHNA INSTITUTE OF NURSING SCIENCES; KRISHNA INSTITUTE OF MEDICAL SCIENCES, DEEMED TO BE UNIVERSITY KARAD, MAHARASHTRA-415539
INDIAN

DR. SATISH V. KAKADE , PROFESSOR ; KRISHNA INSTITUTE OF MEDICAL SCIENCES; KARAD ; DEPARTMENT OF COMMUNITY MEDICINE; KRISHNA INSTITUTE OF MEDICAL SCIENCES DEEMED TO BE UNIVERSITY, KARAD, MAHARASHTRA-415539
INDIAN

DR.ASHA PRATINIDHI , PROFESSOR, EMERITUS; DEPARTMENT OF COMMUNITY MEDICINE, KRISHNA INSTITUTE OF MEDICAL SCIENCES, DEEMED TO BE UNIVERSITY KARAD, MAHARASHTRA-415539
INDIAN

AVINASH H. SALUNKHE , PROFESSOR, & VICE PRINCIPAL KRISHNA INSTITUTE OF NURSING SCIENCES; KRISHNA INSTITUTE OF MEDICAL SCIENCES, DEEMED TO BE UNIVERSITY KARAD, MAHARASHTRA-415539
INDIAN
8. Whether the work is published or unpublished : UNPUBLISHED
9. Year and country of first publication and name, address and nationality of the publisher : N.A.
10. Years and countries of subsequent publications, if any, and names, addresses and nationalities of the publishers : N.A.
11. Names, addresses and nationalities of the owners of various rights comprising the copyright in the work and the extent of rights held by each, together with particulars of assignments and licences, if any : KRISHNA INSTITUTE OF MEDICAL SCIENCES "DEEMED TO BE UNIVERSITY", KARAD , KRISHNA INSTITUTE OF MEDICAL SCIENCES "DEEMED TO BE UNIVERSITY", KARAD, MALKAPUR, KARAD, DIST. SATARA, MAHARASHTRA, INDIA-415539
INDIAN
12. Names, addresses and nationalities of other persons, if any, authorised to assign or licence of rights comprising the copyright : N.A.
13. If the work is an 'Artistic work', the location of the original work, including name, address and nationality of the person in possession of the work. (In the case of an architectural work, the year of completion of the work should also be shown). : N.A.
14. If the work is an 'Artistic work', whether it is registered under the Designs Act 2000 if yes give details. : N.A.
15. If the work is an 'Artistic work', capable of being registered as : N.A.

Extracts from the Register of Copyrights

Dated : 29/11/2018

1. Registration Number : **L-79136/2018**
2. Name, address and nationality of the applicant : KRISHNA INSTITUTE OF MEDICAL SCIENCES "DEEMED TO BE UNIVERSITY", KARAD , KRISHNA INSTITUTE OF MEDICAL SCIENCES "DEEMED TO BE UNIVERSITY", KARAD, MALKAPUR, KARAD, DIST. SATARA, MAHARASHTRA, INDIA-415539
INDIAN
3. Nature of the applicant's interest in the copyright of the work : OWNER
4. Class and description of the work : LITERARY/ ~~DRAMATIC~~ WORK
5. Title of the work : CORRELATIONAL EQUATION OF WEIGHT AND SELECTED ANTHROPOMETRIC PARAMETERS AMONG SCHOOL GOING ADOLESCENTS-A STUDY FROM WESTERN MAHARASHTRA
6. Language of the work : ENGLISH
7. Name, address and nationality of the author and if the author is deceased, date of his decease : DR. P. M. DURGAWALE , PROFESSOR & HEAD DEPT OF COMMUNITY MEDICINE, KIMSUDU, KARAD-415110
INDIAN

DR. SUPRIYA SATISH PATIL , ASSOCIATE PROFESSOR, DEPT OF COMMUNITY MEDICINE, DEAN ACADEMICS KIMSUDU KARAD-415110
INDIAN

DR. SATISH R. PATIL , PROFESSOR, DEPT OF MICROBIOLOGY, KIMSUDU, KARAD-415110
INDIAN
8. Whether the work is published or unpublished : UNPUBLISHED
9. Year and country of first publication and name, address and nationality of the publisher : N.A.
10. Years and countries of subsequent publications, if any, and names, addresses and nationalities of the publishers : N.A.
11. Names, addresses and nationalities of the owners of various rights comprising the copyright in the work and the extent of rights held by each, together with particulars of assignments and licences, if any : KRISHNA INSTITUTE OF MEDICAL SCIENCES "DEEMED TO BE UNIVERSITY", KARAD , KRISHNA INSTITUTE OF MEDICAL SCIENCES "DEEMED TO BE UNIVERSITY", KARAD, MALKAPUR, KARAD, DIST. SATARA, MAHARASHTRA, INDIA-415539
INDIAN
12. Names, addresses and nationalities of other persons, if any, authorised to assign or licence of rights comprising the copyright : N.A.
13. If the work is an 'Artistic work', the location of the original work, including name, address and nationality of the person in possession of the work. (In the case of an architectural work, the year of completion of the work should also be shown). : N.A.
14. If the work is an 'Artistic work', whether it is registered under the Designs Act 2000 if yes give details. : N.A.
15. If the work is an 'Artistic work', capable of being registered as a design under the Designs Act 2000, whether it has been applied to an article through an industrial process and, if yes, the number of times it is reproduced. : N.A.
16. Remarks, if any :

Diary Number : 14913/2018-CO/L
Date of Application : 27/10/2018
Date of Receipt : 27/10/2018



Dated : 10/12/2018

1. Registration Number : **L-79420/2018**
2. Name, address and nationality of the applicant : KRISHNA INSTITUTE OF MEDICAL SCIENCES "DEEMED TO BE UNIVERSITY", KARAD , KRISHNA INSTITUTE OF MEDICAL SCIENCES "DEEMED TO BE UNIVERSITY", KARAD, MALKAPUR, KARAD, DIST. SATARA, MAHARASHTRA, INDIA-415539
INDIAN
3. Nature of the applicant's interest in the copyright of the work : OWNER
4. Class and description of the work : LITERARY/ DRAMATIC WORK
5. Title of the work : DENT ECONOMICS
6. Language of the work : ENGLISH
7. Name, address and nationality of the author and if the author is deceased, date of his decease : DR. SUSHMA BOMMANAVAR , SENIOR LECTURER ,ORAL PATHOLOGY, KRISHNA INSTITUTE OF MEDICAL SCIENCES "DEEMED TO BE UNIVERSITY", KARAD, MALKAPUR, KARAD, DIST. SATARA, MAHARASHTRA, INDIA-415539
INDIAN
8. Whether the work is published or unpublished : UNPUBLISHED
9. Year and country of first publication and name, address and nationality of the publisher : N.A.
10. Years and countries of subsequent publications, if any, and names, addresses and nationalities of the publishers : N.A.
11. Names, addresses and nationalities of the owners of various rights comprising the copyright in the work and the extent of rights held by each, together with particulars of assignments and licences, if any : KRISHNA INSTITUTE OF MEDICAL SCIENCES "DEEMED TO BE UNIVERSITY", KARAD , KRISHNA INSTITUTE OF MEDICAL SCIENCES "DEEMED TO BE UNIVERSITY", KARAD, MALKAPUR, KARAD, DIST. SATARA, MAHARASHTRA, INDIA-415539
INDIAN
12. Names, addresses and nationalities of other persons, if any, authorised to assign or licence of rights comprising the copyright : N.A.
13. If the work is an 'Artistic work', the location of the original work, including name, address and nationality of the person in possession of the work. (In the case of an architectural work, the year of completion of the work should also be shown). : N.A.
14. If the work is an 'Artistic work', whether it is registered under the Designs Act 2000 if yes give details. : N.A.
15. If the work is an 'Artistic work', capable of being registered as a design under the Designs Act 2000.whether it has been applied to an article though an industrial process and ,if yes ,the number of times it is reproduced. : N.A.
16. Remarks, if any

Dated : 10/12/2018

1. Registration Number : **L-79375/2018**
2. Name, address and nationality of the applicant : KRISHNA INSTITUTE OF MEDICAL SCIENCES "DEEMED TO BE UNIVERSITY", KARAD , KRISHNA INSTITUTE OF MEDICAL SCIENCES "DEEMED TO BE UNIVERSITY", KARAD, MALKAPUR, KARAD, DIST. SATARA, MAHARASHTRA, INDIA-415539 INDIAN
3. Nature of the applicant's interest in the copyright of the work : OWNER
4. Class and description of the work : LITERARY/ DRAMATIC WORK
5. Title of the work : MODIFIED INJECTION SYRINGE
6. Language of the work : ENGLISH
7. Name, address and nationality of the author and if the author is deceased, date of his decease : DR. VAISHALI KRISHNAT JAGTAP , KRISHNA INSTITUTE OF MEDICAL SCIENCES "DEEMED TO BE UNIVERSITY", KARAD, MALKAPUR, KARAD, DIST. SATARA, MAHARASHTRA, INDIA-415539 INDIAN
8. Whether the work is published or unpublished : UNPUBLISHED
9. Year and country of first publication and name, address and nationality of the publisher : N.A.
10. Years and countries of subsequent publications, if any, and names, addresses and nationalities of the publishers : N.A.
11. Names, addresses and nationalities of the owners of various rights comprising the copyright in the work and the extent of rights held by each, together with particulars of assignments and licences, if any : KRISHNA INSTITUTE OF MEDICAL SCIENCES "DEEMED TO BE UNIVERSITY", KARAD , KRISHNA INSTITUTE OF MEDICAL SCIENCES "DEEMED TO BE UNIVERSITY", KARAD, MALKAPUR, KARAD, DIST. SATARA, MAHARASHTRA, INDIA-415539 INDIAN
12. Names, addresses and nationalities of other persons, if any, authorised to sign or licence of rights comprising the copyright : N.A.
13. If the work is an 'Artistic work', the location of the original work, including name, address and nationality of the person in possession of the work. (In the case of an architectural work, the year of completion of the work should also be shown). : N.A.
14. If the work is an 'Artistic work', whether it is registered under the Designs Act 2000 if yes give details. : N.A.
15. If the work is an 'Artistic work', capable of being registered as a design under the Designs Act 2000. whether it has been applied to an article though an industrial process and ,if yes ,the number of times it is reproduced. : N.A.
16. Remarks, if any :

Diary Number : 14958/2018-CO/L
Date of Application : 29/10/2018
Date of Receipt : 29/10/2018



**INTELLECTUAL
PROPERTY INDIA**

एकस्व/PATENTS | अभिकल्प/DESIGNS |
व्यापार चिह्न/TRADE MARKS | भौगोलिक
उपदर्शन/GEOGRAPHICAL INDICATIONS



**भारत सरकार
GOVERNMENT OF INDIA**

एकस्व कार्यालय / THE PATENT OFFICE
बौद्धिक सम्पदा भवन / I.P.O. BUILDING
एंटीप हिल/Antop Hill,
एस.एम.रोड/ S.M.Road,
मुंबई/ Mumbai- 400037
दूरभाष /Tel. No.: (091)(022) 24153651
फैक्स / Fax: 022-24130387
ई मेल/ Email: mumbai-patent@nic.in
वेबसाइट /Website: <http://ipindia.nic.in>

सं. \ No. 201821031869

दिनांक \ Dated the 09/04/2019

सेवा में, \ To :

Address of Service:- LEX-REGIA, 246, Gandhi Nagar, Nagpur-440 010, Maharashtra, India
Email Id:-

विषय :- पेटेंट आवेदन संख्या 201821031869 के संबंध में अधिनियम की धारा 43 के तहत पेटेंट अनुदान तथा पेटेंट रजिस्टर में प्रविष्टि की सूचना
Sub :- Intimation of the grant and recordal of patent under section 43 of the Act in respect of patent application no. 201821031869

महोदय/महोदया,
Sir/Madam,

आपको सूचित किया जाता है कि पेटेंट अधिनियम, 1970 की धारा 12 व 13 तथा उस आधार पर बने नियम के तहत उपर्युक्त पेटेंट आवेदन के परीक्षण [व ----- को हुई सुनवाई] के उपरान्त एतद्वारा पेटेंट अनुदान किया जाता है। तथा पेटेंट अनुदान की प्रविष्टि 09/04/2019 को पेटेंट रजिस्टर में कर दी गयी है।

This is to Inform you that following the examination of above mentioned patent application under section 12 and 13 of The Patents Act, 1970 and Rules made thereunder [and hearing held on -----] a patent is hereby granted and recorded in the Register of Patents on the 09/04/2019. The Patent Certificate is enclosed herewith.

पेटेंट संख्या \ Patent No	: 311016
आवेदक का नाम \ Name Of Applicant	: SUNITA HOSHEDAR TATA
पेटेंट दिनांक \ Date of Patent	: 25/08/2018
पूर्विका तिथि \ Priority Date	: 25/08/2018
परीक्षण हेतु अनुरोध दाखिल करने की तिथि \ Filing date of Request for examination	: 30/11/2018
शीर्षक \ Title	: "A DEVICE FOR PHYSICALLY RESTRAINING MOVEMENT"
दावों की संख्या \ Number of claims	: 10

उपर्युक्त पेटेंट के अनुदान का प्रकाशन अधिनियम की धारा 43 के तहत पेटेंट कार्यालय के आधिकारिक जर्नल में किया जाएगा।

The grant of above mentioned patent will be published in the Official Journal of the patent Office under section 43 of the Act.

पेटेंट अधिनियम 1970 यथा संशोधित पेटेंट (संशोधन) नियम, 2005/ पेटेंट नियम, 2003 यथा संशोधित पेटेंट (संशोधन) नियम, 2016 की धारा 142 की उप-धारा (4) के प्रावधानों के तहत उपरोक्त प्रविष्टि की तिथि से 3 माह के भीतर इस कार्यालय में नवीकरण शुल्क जमा किया जाना चाहिए।

The payment of renewal fee is required to be made at this office within three(3) months from the aforesaid date of recording according to the proviso in sub-section(4) of Section 142 of The Patents Act,1970, as amended by The Patents (Amendment) Act, 2005 / The Patents Rules, 2003 as amended by The Patents (Amendment) Rules, 2016.

Parveen Kumar

(नियंत्रक पेटेंट)

Controller of Patents

टिप्पणी / Note :

1. संशोधित नवीकरण शुल्क हेतु कृपया महानियंत्रक पेटेंट, अभिकल्प एवं व्यापार चिह्न की आधिकारिक वेबसाइट www.ipindia.gov.in पर उपलब्ध पेटेंट (संशोधन) नियम 2016 की प्रथम अनुसूची (शुल्क) देखें।

For revised renewal fees kindly refer to the First Schedule (fees) of The Patents (Amendment) Rules 2016 available on the official website of Controller General of Patents, Designs and Trade Marks www.ipindia.gov.in

2. कार्यालय द्वारा पेटेंट प्रमाणपत्र की कोई भी कागजी प्रति अलग से जारी नहीं की जाएगी।

No hard copy of Patent Certificate shall be issued separately by the office.



**INTELLECTUAL
PROPERTY INDIA**

PATENTS | DESIGNS | TRADE MARKS
GEOGRAPHICAL INDICATIONS



सत्यमेव जयते

क्रमांक : 022104436
SL No :



भारत सरकार
GOVERNMENT OF INDIA

पेटेंट कार्यालय
THE PATENT OFFICE

पेटेंट प्रमाणपत्र
PATENT CERTIFICATE
(Rule 74 Of The Patents Rules)

पेटेंट सं. / Patent No. : 311016
आवेदन सं. / Application No. : 201821031869
फाइल करने की तारीख / Date of Filing : 25/08/2018
पेटेंटी / Patentee : SUNITA HOSHEDAR TATA

प्रमाणित किया जाता है कि पेटेंटी को उपरोक्त आवेदन में यथाप्रकटित "A DEVICE FOR PHYSICALLY RESTRAINING MOVEMENT" नामक आविष्कार के लिए, पेटेंट अधिनियम, १९७० के उपबंधों के अनुसार आज तारीख 25th day of August 2018 से बीस वर्ष की अवधि के लिए पेटेंट अनुदत्त किया गया है।

It is hereby certified that a patent has been granted to the patentee for an invention entitled "A DEVICE FOR PHYSICALLY RESTRAINING MOVEMENT" as disclosed in the above mentioned application for the term of 20 years from the 25th day of August 2018 in accordance with the provisions of the Patents Act, 1970.



अनुदान की तारीख : 09/04/2019
Date of Grant :

पेटेंट नियंत्रक
Controller of Patent

OkSupte

टिप्पणी - इस पेटेंट के नवीकरण के लिए फीस, यदि इसे बनाए रखा जाना है, 25th day of August 2020 को और उसके पश्चात प्रत्येक वर्ष में उसी दिन देय होगी।

Note. - The fees for renewal of this patent, if it is to be maintained will fall / has fallen due on 25th day of August 2020 and on the same day in every year thereafter.



**INTELLECTUAL
PROPERTY INDIA**

एकस्व/PATENTS|अभिकल्प/DESIGNS|
व्यापार चिह्न/TRADE MARKS|भौगोलिक
उपदर्शन/GEOGRAPHICAL INDICATIONS



**भारत सरकार
GOVERNMENT OF INDIA**

एकस्व कार्यालय /THE PATENT OFFICE
बौद्धिक सम्पदा भवन / I.P.O. BUILDING
एंटीप हिल/Antop Hill,
एस.एम.रोड/ S.M.Road,
मुंबई/ Mumbai- 400037
दूरभाष /Tel. No.: (091)(022)24153651
फैक्स/ Fax: 022-24130387
ई मेल/ Email: mumbai-patent@nic.in
वेबसाइट /Website:<http://ipindia.nic.in>

सं. \ No. 201821031870

दिनांक \ Dated the 21/06/2019

सेवा मे, \ To :

Address of Service:- LEX-REGIA, 246, Gandhi Nagar, Nagpur-440 010, Maharashtra, India

Email Id:- mailbox@lexregia.in

विषय :- पेटेंट आवेदन संख्या 201821031870 के संबंध में अधिनियम की धारा 43 के तहत पेटेंट अनुदान तथा पेटेंट रजिस्टर में प्रविष्टि की सूचना

Sub :- Intimation of the grant and recordal of patent under section 43 of the Act in respect of patent application no. 201821031870

महोदय/महोदया,

Sir/Madam,

आपको सूचित किया जाता है कि पेटेंट अधिनियम, 1970 की धारा 12 व 13 तथा उस आधार पर बने नियम के तहत उपर्युक्त पेटेंट आवेदन के परीक्षण [व 16/05/2019 को हुई सुनवाई] के उपरांत एतद्वारा पेटेंट अनुदान किया जाता है। तथा पेटेंट अनुदान की प्रविष्टि 21/06/2019 को पेटेंट रजिस्टर में कर दी गयी है।

This is to Inform you that following the examination of above mentioned patent application under section 12 and 13 of The Patents Act, 1970 and Rules made thereunder [and hearing held on 16/05/2019] a patent is hereby granted and recorded in the Register of Patents on the 21/06/2019. The Patent Certificate is enclosed herewith.

पेटेंट संख्या \ Patent No	:	314417
आवेदक का नाम \ Name Of Applicant	:	RAJASHRI BHAGWAT KARALE
पेटेंट दिनांक \ Date of Patent	:	25/08/2018
पूर्विका तिथि \ Priority Date	:	25/08/2018
परीक्षण हेतु अनुरोध दाखिल करने की तिथि \ Filing date of Request for examination	:	30/11/2018
शीर्षक \ Title	:	"AN INJECTION GUIDE"
दावों की संख्या \ Number of claims	:	4

उपर्युक्त पेटेंट के अनुदान का प्रकाशन अधिनियम की धारा 43 के तहत पेटेंट कार्यालय के आधिकारिक जर्नल में किया जाएगा।

The grant of above mentioned patent will be published in the Official Journal of the patent Office under section 43 of the Act.

पेटेंट अधिनियम 1970 यथा संशोधित पेटेंट (संशोधन) नियम, 2005/ पेटेंट नियम, 2003 यथा संशोधित पेटेंट (संशोधन) नियम, 2016 की धारा 142 की उप-धारा (4) के प्रावधानों के तहत उपरोक्त प्रविष्टि की तिथि से 3 माह के भीतर इस कार्यालय में नवीकरण शुल्क जमा किया जाना चाहिए।

The payment of renewal fee is required to be made at this office within three(3) months from the aforesaid date of recording according to the proviso in sub-section(4) of Section 142 of The Patents Act,1970, as amended by The Patents (Amendment) Act, 2005 / The Patents Rules, 2003 as amended by The Patents (Amendment) Rules, 2016.

Aditya Venkateswara N C

(नियंत्रक पेटेंट)

Controller of Patents

टिप्पणी / Note :

1. संशोधित नवीकरण शुल्क हेतु कृपया महानियंत्रक पेटेंट, अभिकल्प एवं व्यापार चिह्न की आधिकारिक वेबसाइट www.ipindia.gov.in पर उपलब्ध पेटेंट (संशोधन) नियम 2016 की प्रथम अनुसूची (शुल्क) देखें।

For revised renewal fees kindly refer to the First Schedule (fees) of The Patents (Amendment) Rules 2016 available on the official website of Controller General of Patents, Designs and Trade Marks www.ipindia.gov.in

2. कार्यालय द्वारा पेटेंट प्रमाणपत्र की कोई भी कागजी प्रति अलग से जारी नहीं की जाएगी।

No hard copy of Patent Certificate shall be issued separately by the office.



**INTELLECTUAL
PROPERTY INDIA**

PATENTS | DESIGNS | TRADE MARKS
GEOGRAPHICAL INDICATIONS



सत्यमेव जयते

भारत सरकार
GOVERNMENT OF INDIA

पेटेंट कार्यालय
THE PATENT OFFICE

पेटेंट प्रमाणपत्र
PATENT CERTIFICATE
(Rule 74 Of The Patents Rules)

क्रमांक : 022104976
SL No :



पेटेंट सं. / Patent No. : 314417
आवेदन सं. / Application No. : 201821031870
फाइल करने की तारीख / Date of Filing : 25/08/2018
पेटेंटी / Patentee : RAJASHRI BHAGWAT KARALE

प्रमाणित किया जाता है कि पेटेंटी को उपरोक्त आवेदन में यथाप्रकटित "AN INJECTION GUIDE" नामक आविष्कार के लिए, पेटेंट अधिनियम, १९७० के उपबंधों के अनुसार आज तारीख 25th day of August 2018 से बीस वर्ष की अवधि के लिए पेटेंट अनुदत्त किया गया है।

It is hereby certified that a patent has been granted to the patentee for an invention entitled "AN INJECTION GUIDE" as disclosed in the above mentioned application for the term of 20 years from the 25th day of August 2018 in accordance with the provisions of the Patents Act, 1970.



अनुदान की तारीख : 21/06/2019
Date of Grant :

पेटेंट नियंत्रक
Controller of Patent

OkSupte

टिप्पणी - इस पेटेंट के नवीकरण के लिए फीस, यदि इसे बनाए रखा जाना है, **25th day of August 2020** को और उसके पश्चात प्रत्येक वर्ष में उसी दिन देय होगी।

Note. - The fees for renewal of this patent, if it is to be maintained will fall / has fallen due on **25th day of August 2020** and on the same day in every year thereafter.



**INTELLECTUAL
PROPERTY INDIA**

एकस्व/PATENTS|अभिकल्प/DESIGNS|
व्यापार चिह्न/TRADE MARKS|भौगोलिक
उपदर्शन/GEOGRAPHICAL INDICATIONS



सत्यमेव जयते

**भारत सरकार
GOVERNMENT OF INDIA**

एकस्व कार्यालय /THE PATENT OFFICE
बौद्धिक सम्पदा भवन / I.P.O. BUILDING
एंटीप हिल/Antop Hill,
एस.एम. रोड/ S.M.Road,
मुंबई/ Mumbai- 400037
दूरभाष /Tel. No.: (091)(022) 2415365 1
फैक्स / Fax: 022-24130387
ई मेल/ Email: mumbai-patent@nic.in
वेबसाइट /Website: <http://ipindia.nic.in>

सं. \ No. 623/MUM/2010

दिनांक \ Dated the 28/10/2019

सेवा मे, \ To :

Address of Service:- Lex-Regia, 246, Gandhi Nagar, Nagpur-440 010, Maharashtra, India”

Email Id:- advgnbhav@gmail.com, mailbox@lexregia.in, royak777@gmail.com

विषय :- पेटेंट आवेदन संख्या 623/MUM/2010 के संबंध में अधिनियम की धारा 43 के तहत पेटेंट अनुदान तथा पेटेंट रजिस्टर में प्रविष्टि की सूचना

Sub :- Intimation of the grant and recordal of patent under section 43 of the Act in respect of patent application no. 623/MUM/2010

महोदय/महोदया,

Sir/Madam,

आपको सूचित किया जाता है कि पेटेंट अधिनियम, 1970 की धारा 12 व 13 तथा उस आधार पर बने नियम के तहत उपर्युक्त पेटेंट आवेदन के परीक्षण [व 08/08/2019 को हुई सुनवाई] के उपरांत एतद्वारा पेटेंट अनुदान किया जाता है। तथा पेटेंट अनुदान की प्रविष्टि 28/10/2019 को पेटेंट रजिस्टर में कर दी गयी है।

This is to Inform you that following the examination of above mentioned patent application under section 12 and 13 of The Patents Act, 1970 and Rules made thereunder [and hearing held on 08/08/2019] a patent is hereby granted and recorded in the Register of Patents on the 28/10/2019. The Patent Certificate is enclosed herewith.

पेटेंट संख्या \ Patent No	: 323819
आवेदक का नाम \ Name Of Applicant	: KRISHNA INSTITUTE OF MEDICAL SCIENCES
पेटेंट दिनांक \ Date of Patent	: 09/03/2010
पूर्विका तिथि \ Priority Date	: 09/03/2010
परीक्षण हेतु अनुरोध दाखिल करने की तिथि \ Filing date of Request for examination	: 07/03/2011
शीर्षक \ Title	: SIMULATION TRAINING DEVICE FOR ASSESSMENT OF THE CERVICAL DILATATION
दावों की संख्या \ Number of claims	: 1 Claim filed on 21/09/2019

उपर्युक्त पेटेंट के अनुदान का प्रकाशन अधिनियम की धारा 43 के तहत पेटेंट कार्यालय के आधिकारिक जर्नल में किया जाएगा।

The grant of above mentioned patent will be published in the Official Journal of the patent Office under section 43 of the Act.

पेटेंट अधिनियम 1970 यथा संशोधित पेटेंट (संशोधन) नियम, 2005/ पेटेंट नियम, 2003 यथा संशोधित पेटेंट (संशोधन) नियम, 2016 की धारा 142 की उप-धारा (4) के प्रावधानों के तहत उपरोक्त प्रविष्टि की तिथि से 3 माह के भीतर इस कार्यालय में नवीकरण शुल्क जमा किया जाना चाहिए।

The payment of renewal fee is required to be made at this office within three(3) months from the aforesaid date of recording according to the proviso in sub-section(4) of Section 142 of The Patents Act,1970, as amended by The Patents (Amendment) Act, 2005 / The Patents Rules, 2003 as amended by The Patents (Amendment) Rules, 2016.

Santosh Mehtry

(नियंत्रक पेटेंट)

Controller of Patents

टिप्पणी / Note :

1. संशोधित नवीकरण शुल्क हेतु कृपया महानियंत्रक पेटेंट, अभिकल्प एवं व्यापार चिह्न की आधिकारिक वेबसाइट www.ipindia.gov.in पर उपलब्ध पेटेंट (संशोधन) नियम 2016 की प्रथम अनुसूची (शुल्क) देखें।

For revised renewal fees kindly refer to the First Schedule (fees) of The Patents (Amendment) Rules 2016 available on the official website of Controller General of Patents, Designs and Trade Marks www.ipindia.gov.in

2. कार्यालय द्वारा पेटेंट प्रमाणपत्र की कोई भी कागजी प्रति अलग से जारी नहीं की जाएगी।

No hard copy of Patent Certificate shall be issued separately by the office.



**INTELLECTUAL
PROPERTY INDIA**

PATENTS | DESIGNS | TRADE MARKS
GEOGRAPHICAL INDICATIONS



सत्यमेव जयते

क्रमांक : 022106367
SL No :



भारत सरकार
GOVERNMENT OF INDIA

पेटेंट कार्यालय
THE PATENT OFFICE

पेटेंट प्रमाणपत्र
PATENT CERTIFICATE
(Rule 74 Of The Patents Rules)

पेटेंट सं. / Patent No. : 323819
आवेदन सं. / Application No. : 623/MUM/2010
फाइल करने की तारीख / Date of Filing : 09/03/2010
पेटेंटी / Patentee : KRISHNA INSTITUTE OF MEDICAL SCIENCES

प्रमाणित किया जाता है कि पेटेंटी को उपरोक्त आवेदन में यथाप्रकटित SIMULATION TRAINING DEVICE FOR ASSESSMENT OF THE CERVICAL DILATATION नामक आविष्कार के लिए, पेटेंट अधिनियम, १९७० के उपबंधों के अनुसार आज तारीख 9th day of March 2010 से बीस वर्ष की अवधि के लिए पेटेंट अनुदत्त किया गया है।

It is hereby certified that a patent has been granted to the patentee for an invention entitled SIMULATION TRAINING DEVICE FOR ASSESSMENT OF THE CERVICAL DILATATION as disclosed in the above mentioned application for the term of 20 years from the 9th day of March 2010 in accordance with the provisions of the Patents Act, 1970.



अनुदान की तारीख : 28/10/2019
Date of Grant :

पेटेंट नियंत्रक
Controller of Patent

Okrupte

टिप्पणी - इस पेटेंट के नवीकरण के लिए फीस, यदि इसे बनाए रखा जाना है, 9th day of March 2012 को और उसके पश्चात प्रत्येक वर्ष में उसी दिन देय होगी।

Note. - The fees for renewal of this patent, if it is to be maintained will fall / has fallen due on 9th day of March 2012 and on the same day in every year thereafter.



**INTELLECTUAL
PROPERTY INDIA**

एकस्व/PATENTS|अभिकल्प/DESIGNS|
व्यापार चिह्न/TRADE MARKS|भौगोलिक
उपदर्शन/GEOGRAPHICAL INDICATIONS



सत्यमेव जयते

**भारत सरकार
GOVERNMENT OF INDIA**

एकस्व कार्यालय /THE PATENT OFFICE
बौद्धिक सम्पदा भवन / I.P.O. BUILDING
एंटीप हिल/Antop Hill,
एस.एम. रोड/ S.M.Road,
मुंबई/ Mumbai- 400037
दूरभाष /Tel. No.: (091)(022) 24153651
फैक्स/ Fax: 022-24130387
ई मेल/ Email: mumbai-patent@nic.in
वेबसाइट /Website: <http://ipindia.nic.in>

सं. \ No. 216/MUM/2011

दिनांक \ Dated the 25/11/2019

सेवा मे, \ To :

Address of Service:- Lex-Regia, 246, Gandhi Nagar, Nagpur-440 010, Maharashtra, India”

Email Id:- advgnbhav@gmail.com, mailbox@lexregia.in, mailbox@lexregia.in

विषय :- पेटेंट आवेदन संख्या 216/MUM/2011 के संबंध में अधिनियम की धारा 43 के तहत पेटेंट अनुदान तथा पेटेंट रजिस्टर में प्रविष्टि की सूचना

Sub :- Intimation of the grant and recordal of patent under section 43 of the Act in respect of patent application no. 216/MUM/2011

महोदय/महोदया,

Sir/Madam,

आपको सूचित किया जाता है कि पेटेंट अधिनियम, 1970 की धारा 12 व 13 तथा उस आधार पर बने नियम के तहत उपर्युक्त पेटेंट आवेदन के परीक्षण [व 08/08/2019 को हुई सुनवाई] के उपरांत एतद्वारा पेटेंट अनुदान किया जाता है। तथा पेटेंट अनुदान की प्रविष्टि 25/11/2019 को पेटेंट रजिस्टर में कर दी गयी है।

This is to Inform you that following the examination of above mentioned patent application under section 12 and 13 of The Patents Act, 1970 and Rules made thereunder [and hearing held on 08/08/2019] a patent is hereby granted and recorded in the Register of Patents on the 25/11/2019. The Patent Certificate is enclosed herewith.

पेटेंट संख्या \ Patent No	: 325699
आवेदक का नाम \ Name Of Applicant	: KRISHNA INSTITUTE OF MEDICAL SCIENCES
पेटेंट दिनांक \ Date of Patent	: 24/01/2011
पूर्विका तिथि \ Priority Date	: 24/01/2011
परीक्षण हेतु अनुरोध दाखिल करने की तिथि \ Filing date of Request for examination	: 07/03/2011
शीर्षक \ Title	: ENDOCERVICAL & ECTOCERVICAL SPATULA FOR COLLECTION OF SAMPLE FOR CERVICAL CYTOLOGY
दावों की संख्या \ Number of claims	: 1 Claim filed on 24/10/2019

उपर्युक्त पेटेंट के अनुदान का प्रकाशन अधिनियम की धारा 43 के तहत पेटेंट कार्यालय के आधिकारिक जर्नल में किया जाएगा।

The grant of above mentioned patent will be published in the Official Journal of the patent Office under section 43 of the Act.

पेटेंट अधिनियम 1970 यथा संशोधित पेटेंट (संशोधन) नियम, 2005/ पेटेंट नियम, 2003 यथा संशोधित पेटेंट (संशोधन) नियम, 2016 की धारा 142 की उप-धारा (4) के प्रावधानों के तहत उपरोक्त प्रविष्टि की तिथि से 3 माह के भीतर इस कार्यालय में नवीकरण शुल्क जमा किया जाना चाहिए।

The payment of renewal fee is required to be made at this office within three(3) months from the aforesaid date of recording according to the proviso in sub-section(4) of Section 142 of The Patents Act,1970, as amended by The Patents (Amendment) Act, 2005 / The Patents Rules, 2003 as amended by The Patents (Amendment) Rules, 2016.

Santosh Mehtry

(नियंत्रक पेटेंट)

Controller of Patents

टिप्पणी / Note :

1. संशोधित नवीकरण शुल्क हेतु कृपया महानियंत्रक पेटेंट, अभिकल्प एवं व्यापार चिह्न की आधिकारिक वेबसाइट www.ipindia.gov.in पर उपलब्ध पेटेंट (संशोधन) नियम 2016 की प्रथम अनुसूची (शुल्क) देखें।

For revised renewal fees kindly refer to the First Schedule (fees) of The Patents (Amendment) Rules 2016 available on the official website of Controller General of Patents, Designs and Trade Marks www.ipindia.gov.in

2. कार्यालय द्वारा पेटेंट प्रमाणपत्र की कोई भी कागजी प्रति अलग से जारी नहीं की जाएगी।

No hard copy of Patent Certificate shall be issued separately by the office.



**INTELLECTUAL
PROPERTY INDIA**

PATENTS | DESIGNS | TRADE MARKS
GEOGRAPHICAL INDICATIONS



सत्यमेव जयते

भारत सरकार
GOVERNMENT OF INDIA

पेटेंट कार्यालय
THE PATENT OFFICE

पेटेंट प्रमाणपत्र
PATENT CERTIFICATE
(Rule 74 Of The Patents Rules)

क्रमांक : 022106627
SL No :



पेटेंट सं. / Patent No. : 325699
आवेदन सं. / Application No. : 216/MUM/2011
फाइल करने की तारीख / Date of Filing : 24/01/2011
पेटेंटी / Patentee : KRISHNA INSTITUTE OF MEDICAL SCIENCES

प्रमाणित किया जाता है कि पेटेंटी को उपरोक्त आवेदन में यथाप्रकटित ENDOCERVICAL & ECTOCERVICAL SPATULA FOR COLLECTION OF SAMPLE FOR CERVICAL CYTOLOGY नामक आविष्कार के लिए, पेटेंट अधिनियम, १९७० के उपबंधों के अनुसार आज तारीख 24th day of January 2011 से बीस वर्ष की अवधि के लिए पेटेंट अनुदत्त किया गया है।

It is hereby certified that a patent has been granted to the patentee for an invention entitled ENDOCERVICAL & ECTOCERVICAL SPATULA FOR COLLECTION OF SAMPLE FOR CERVICAL CYTOLOGY as disclosed in the above mentioned application for the term of 20 years from the 24th day of January 2011 in accordance with the provisions of the Patents Act,1970.



अनुदान की तारीख : 25/11/2019
Date of Grant :

OkSupte
पेटेंट नियंत्रक
Controller of Patent

टिप्पणी - इस पेटेंट के नवीकरण के लिए फीस, यदि इसे बनाए रखा जाना है, 24th day of January 2013 को और उसके पश्चात प्रत्येक वर्ष में उसी दिन देय होगी।

Note. - The fees for renewal of this patent, if it is to be maintained will fall / has fallen due on 24th day of January 2013 and on the same day in every year thereafter.

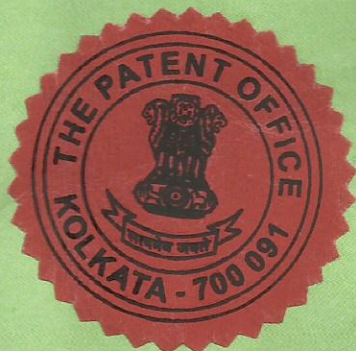

ORIGINAL

No. 76927

भारत सरकार
GOVERNMENT OF INDIA
पेटेंट कार्यालय
THE PATENT OFFICE

CERTIFICATE OF REGISTRATION OF DESIGN

Design No. 314161-001
Date 23/01/2019 12:44:00
Reciprocity Date*
Country

Certified that the design of which a copy is annexed hereto has been registered as of the number and date given above in class 04-02 in respect of the application of such design to TOOTHBRUSH in the name of 1.GIRISH SURAGIMATH, KRISHNA INSTITUTE OF MEDICAL SCIENCES, NEAR DHEBEWADI ROAD, MALKAPUR, KARAD, MAHARASHTRA, INDIA, PIN CODE: 415110 2. ASHWINIRANI SR, KRISHNA INSTITUTE OF MEDICAL SCIENCES, NEAR DHEBEWADI ROAD, MALKAPUR, KARAD, MAHARASHTRA, INDIA, PIN CODE: 415110

in pursuance of and subject to the provisions of the Designs Act, 2000 and the Designs Rules, 2001.

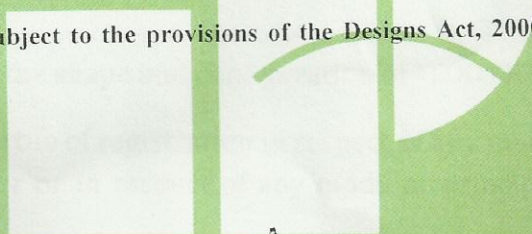

OK Sample

INTELLECTUAL
Controller General of Patents, Designs and Trade Marks
PROPERTY INDIA

*The reciprocity date (if any) which has been allowed and the name of the country.
Copyright in the design will subsist for ten years from the date of Registration, and may under the terms of the Act and Rules, be extended for a further period of five years.
This Certificate is not for use in legal proceedings or for obtaining registration abroad

ARGHYA ASHIS ROY,
LEX REGIA 246, GANDHI NAGAR, NAGPUR-440 010
MAHARASHTRA, INDIA

Date of Issue 02/07/2019 13:44:48



Controller General of Patents, Designs and Trademarks
Department of Industrial Policy and Promotion
Ministry of Commerce and Industry

Application Details

APPLICATION NUMBER	201921004683
APPLICATION TYPE	ORDINARY APPLICATION
DATE OF FILING	06/02/2019
APPLICANT NAME	Dr. Yusuf Ahammed. A. Ronad
TITLE OF INVENTION	HYBRID HYGIENIC FUSED TOOTH BRUSH AND TOOTHPASTE
FIELD OF INVENTION	GENERAL ENGINEERING
E-MAIL (As Per Record)	legactual@gmail.com
ADDITIONAL-EMAIL (As Per Record)	legactual@gmail.com
E-MAIL (UPDATED Online)	
PRIORITY DATE	NA
REQUEST FOR EXAMINATION DATE	04/04/2019
PUBLICATION DATE (U/S 11A)	19/04/2019

Application Status

APPLICATION STATUS	Application Awaiting Examination
--------------------	---

[View Documents](#)

 Controller General of Patents, Designs and Trademarks
 Department of Industrial Policy and Promotion
 Ministry of Commerce and Industry

Application Details

APPLICATION NUMBER	201921012466
APPLICATION TYPE	ORDINARY APPLICATION
DATE OF FILING	29/03/2019
APPLICANT NAME	SAMEER SUDHIR KARPE
TITLE OF INVENTION	"CUSTOMISED ANKLE FOOT ORTHOTIC DEVICE"
FIELD OF INVENTION	BIO-MEDICAL ENGINEERING
E-MAIL (As Per Record)	mailbox@lexregia.in
ADDITIONAL-EMAIL (As Per Record)	royak777@gmail.com
E-MAIL (UPDATED Online)	
PRIORITY DATE	NA
REQUEST FOR EXAMINATION DATE	13/06/2019
PUBLICATION DATE (U/S 11A)	03/05/2019
FIRST EXAMINATION REPORT DATE	24/07/2019
Date Of Certificate Issue	25/02/2020
POST GRANT JOURNAL DATE	28/02/2020
REPLY TO FER DATE	03/09/2019

Application Status

APPLICATION STATUS	Granted Application, Patent Number :332801
--------------------	---

[E-Register](#)
[View Documents](#)

 Controller General of Patents, Designs and Trademarks
Department of Industrial Policy and Promotion
Ministry of Commerce and Industry

Application Details

APPLICATION NUMBER	201921022288
APPLICATION TYPE	ORDINARY APPLICATION
DATE OF FILING	05/06/2019
APPLICANT NAME	Krishna Institute of Medical Sciences "Deemed to be University"
TITLE OF INVENTION	A DEVICE FOR MEASURING TENSION IN A WIRE OF AN ORTHODONTIC BRACES
FIELD OF INVENTION	ELECTRICAL
E-MAIL (As Per Record)	patent@brainiac.co.in
ADDITIONAL-EMAIL (As Per Record)	patent@brainiac.co.in
E-MAIL (UPDATED Online)	
PRIORITY DATE	NA
REQUEST FOR EXAMINATION DATE	06/09/2019
PUBLICATION DATE (U/S 11A)	19/07/2019
FIRST EXAMINATION REPORT DATE	03/10/2019
REPLY TO FER DATE	11/12/2019

Application Status

APPLICATION STATUS	Application in Amended stage
--------------------	-------------------------------------

[View Documents](#)



Controller General of Patents, Designs and Trademarks
Department of Industrial Policy and Promotion
Ministry of Commerce and Industry

Application Details

APPLICATION NUMBER	201921024231
APPLICATION TYPE	ORDINARY APPLICATION
DATE OF FILING	18/06/2019
APPLICANT NAME	1 . NEELIMA ANIL MALIK 2 . SHIVSAGAR TEWARY
TITLE OF INVENTION	A LIP POSTURE CORRECTOR
FIELD OF INVENTION	CHEMICAL
E-MAIL (As Per Record)	mailbox@lexregia.in
ADDITIONAL-EMAIL (As Per Record)	royak777@gmail.com
E-MAIL (UPDATED Online)	
PRIORITY DATE	NA
REQUEST FOR EXAMINATION DATE	21/08/2019
PUBLICATION DATE (U/S 11A)	19/07/2019
FIRST EXAMINATION REPORT DATE	18/09/2019
Date Of Certificate Issue	05/03/2020
POST GRANT JOURNAL DATE	06/03/2020
REPLY TO FER DATE	06/10/2019

Application Status

APPLICATION STATUS	Granted Application, Patent Number :333981
--------------------	---

[E-Register](#)
[View Documents](#)



Controller General of Patents, Designs and Trademarks
Department of Industrial Policy and Promotion
Ministry of Commerce and Industry

Application Details

APPLICATION NUMBER	201921019049
APPLICATION TYPE	ORDINARY APPLICATION
DATE OF FILING	13/05/2019
APPLICANT NAME	Krishna Institute of Medical Sciences "Deemed to be University"
TITLE OF INVENTION	AN ORTHOTIC DEVICE FOR SUPPORTING A SHOULDER JOINT OF A USER
FIELD OF INVENTION	BIO-MEDICAL ENGINEERING
E-MAIL (As Per Record)	patent@brainiac.co.in
ADDITIONAL-EMAIL (As Per Record)	patent@brainiac.co.in
E-MAIL (UPDATED Online)	
PRIORITY DATE	NA
REQUEST FOR EXAMINATION DATE	25/07/2019
PUBLICATION DATE (U/S 11A)	26/07/2019
FIRST EXAMINATION REPORT DATE	03/09/2019
Date Of Certificate Issue	21/02/2020
POST GRANT JOURNAL DATE	28/02/2020
REPLY TO FER DATE	28/09/2019

Application Status

APPLICATION STATUS	Granted Application, Patent Number :332628
--------------------	---

[E-Register](#)
[Order\(s\)/Decision\(s\)](#)
[View Documents](#)

 Controller General of Patents, Designs and Trademarks
 Department of Industrial Policy and Promotion
 Ministry of Commerce and Industry

Application Details

APPLICATION NUMBER	201721040701
APPLICATION TYPE	ORDINARY APPLICATION
DATE OF FILING	14/11/2017
APPLICANT NAME	Krishna Institute of Medical Sciences
TITLE OF INVENTION	METALLIC MUCOSAL PUNCH
FIELD OF INVENTION	BIO-MEDICAL ENGINEERING
E-MAIL (As Per Record)	patent@brainiac.co.in
ADDITIONAL-EMAIL (As Per Record)	info@brb-legal.com
E-MAIL (UPDATED Online)	patent@brainiac.co.in
PRIORITY DATE	NA
REQUEST FOR EXAMINATION DATE	26/03/2019
PUBLICATION DATE (U/S 11A)	18/10/2019

Application Status

APPLICATION STATUS	Application Awaiting Examination
--------------------	---

[View Documents](#)

Dated : 10/01/2019

1. Registration Number : **L-80092/2019**
2. Name, address and nationality of the applicant : DR. NEELIMA A. MALIK , VICE-CHANCELLOR, KRISHNA INSTITUTE OF MEDICAL SCIENCES DEEMED UNIVERSITY KARAD, MALKAPUR, TAL. KARAD, DIST. SATARA-415539 INDIAN
3. Nature of the applicant's interest in the copyright of the work : AUTHOR
4. Class and description of the work : LITERARY/ DRAMATIC WORK
5. Title of the work : BIOPHYSIOLOGICAL WASTE
6. Language of the work : ENGLISH
7. Name, address and nationality of the author and if the author is deceased, date of his decease : DR. NEELIMA A. MALIK , VICE-CHANCELLOR, KRISHNA INSTITUTE OF MEDICAL SCIENCES DEEMED UNIVERSITY KARAD, MALKAPUR, TAL. KARAD, DIST. SATARA-415539 INDIAN
8. Whether the work is published or unpublished : UNPUBLISHED
9. Year and country of first publication and name, address and nationality of the publisher : N.A.
10. Years and countries of subsequent publications, if any, and names, addresses and nationalities of the publishers : N.A.
11. Names, addresses and nationalities of the owners of various rights comprising the copyright in the work and the extent of rights held by each, together with particulars of assignments and licences, if any : DR. NEELIMA A. MALIK , VICE-CHANCELLOR, KRISHNA INSTITUTE OF MEDICAL SCIENCES DEEMED UNIVERSITY KARAD, MALKAPUR, TAL. KARAD, DIST. SATARA-415539 INDIAN
12. Names, addresses and nationalities of other persons, if any, authorised to assign or licence of rights comprising the copyright : N.A.
13. If the work is an 'Artistic work', the location of the original work, including name, address and nationality of the person in possession of the work. (In the case of an architectural work, the year of completion of the work should also be shown). : N.A.
14. If the work is an 'Artistic work', whether it is registered under the Designs Act 2000 if yes give details. : N.A.
15. If the work is an 'Artistic work', capable of being registered as a design under the Designs Act 2000. whether it has been applied to an article though an industrial process and ,if yes ,the number of times it is reproduced. : N.A.
16. Remarks, if any :

Diary Number : 2681/2018-CO/L
Date of Application : 21/02/2018
Date of Receipt : 21/02/2018

Dated : 14/02/2019

1. Registration Number : **L-80943/2019**
2. Name, address and nationality of the applicant : KRISHNA INSTITUTE OF MEDICAL SCIENCES "DEEMED TO BE UNIVERSITY", REGISTRAR DR. M. V. GHORPADE , KRISHNA INSTITUTE OF MEDICAL SCIENCES "DEEMED TO BE UNIVERSITY" NEAR DHEBEWADI ROAD, MALKAPUR TAL - KARAD. PIN - 415539 DIST. - SATARA, MAHARASHTRA, INDIA-415539 INDIAN
3. Nature of the applicant's interest in the copyright of the work : OWNER
4. Class and description of the work : LITERARY/ DRAMATIC WORK
5. Title of the work : MANUAL ON EXERCISES ARPT (AFTER REGULAR PHYSIOTHERAPY)
6. Language of the work : ENGLISH
7. Name, address and nationality of the author and if the author is deceased, date of his decease : DR. G VARADHARAJULU , DEAN, FACULTY OF PHYSIOTHERAPY, KRISHNA INSTITUTE OF MEDICAL SCIENCES, KRISHNA INSTITUTE OF MEDICAL SCIENCES "DEEMED TO BE UNIVERSITY", NEAR DHEBEWADI ROAD, MALKAPUR, TAL - KARAD. PIN - 415539, DIST-415539 INDIAN
8. Whether the work is published or unpublished : UNPUBLISHED
9. Year and country of first publication and name, address and nationality of the publisher : N.A.
10. Years and countries of subsequent publications, if any, and names, addresses and nationalities of the publishers : N.A.
11. Names, addresses and nationalities of the owners of various rights comprising the copyright in the work and the extent of rights held by each, together with particulars of assignments and licences, if any : KRISHNA INSTITUTE OF MEDICAL SCIENCES "DEEMED TO BE UNIVERSITY", REGISTRAR DR. M. V. GHORPADE , KRISHNA INSTITUTE OF MEDICAL SCIENCES "DEEMED TO BE UNIVERSITY" NEAR DHEBEWADI ROAD, MALKAPUR TAL - KARAD. PIN - 415539 DIST. - SATARA, MAHARASHTRA, INDIA-415539 INDIAN
12. Names, addresses and nationalities of other persons, if any, authorised to assign or licence of rights comprising the copyright : KRISHNA INSTITUTE OF MEDICAL SCIENCES "DEEMED TO BE UNIVERSITY", REGISTRAR DR. M. V. GHORPADE , KRISHNA INSTITUTE OF MEDICAL SCIENCES "DEEMED TO BE UNIVERSITY" NEAR DHEBEWADI ROAD, MALKAPUR TAL - KARAD. PIN - 415539 DIST. - SATARA, MAHARASHTRA, INDIA-415539 INDIAN
13. If the work is an 'Artistic work', the location of the original work, including name, address and nationality of the person in possession of the work. (In the case of an architectural work, the year of completion of the work should also be shown). : N.A.
14. If the work is an 'Artistic work', whether it is registered : N.A.

Dated : 28/02/2019

1. Registration Number : **L-81214/2019**
2. Name, address and nationality of the applicant : KRISHNA INSTITUTE OF MEDICAL SCIENCES DEEMED TO BE UNIVERSITY, KARAD , KRISHNA INSTITUTE OF MEDICAL SCIENCES DEEMED TO BE UNIVERSITY, KARAD MALKAPUR, KARAD, DIST. SATARA, MAHARASHTRA-415539 INDIAN
3. Nature of the applicant's interest in the copyright of the work : OWNER
4. Class and description of the work : LITERARY/ DRAMATIC WORK
5. Title of the work : TRAINING PROGRAM OF SURGICAL RESIDENTS
6. Language of the work : ENGLISH
7. Name, address and nationality of the author and if the author is deceased, date of his decease : DR. RAMCHANDRA GANESH NANIWADEKAR , PROFESSOR IN SURGERY, KRISHNA INSTITUTE OF MEDICAL SCIENCES DEEMED TO BE UNIVERSITY, KARAD MALKAPUR, KARAD, DIST. SATARA, MAHARASHTRA-415539 INDIAN
8. Whether the work is published or unpublished : UNPUBLISHED
9. Year and country of first publication and name, address and nationality of the publisher : N.A.
10. Years and countries of subsequent publications, if any, and names, addresses and nationalities of the publishers : N.A.
11. Names, addresses and nationalities of the owners of various rights comprising the copyright in the work and the extent of rights held by each, together with particulars of assignments and licences, if any : KRISHNA INSTITUTE OF MEDICAL SCIENCES DEEMED TO BE UNIVERSITY, KARAD , KRISHNA INSTITUTE OF MEDICAL SCIENCES DEEMED TO BE UNIVERSITY, KARAD MALKAPUR, KARAD, DIST. SATARA, MAHARASHTRA-415539 INDIAN
12. Names, addresses and nationalities of other persons, if any, authorised to assign or licence of rights comprising the copyright : N.A.
13. If the work is an 'Artistic work', the location of the original work, including name, address and nationality of the person in possession of the work. (In the case of an architectural work, the year of completion of the work should also be shown). : N.A.
14. If the work is an 'Artistic work', whether it is registered under the Designs Act 2000 if yes give details. : N.A.
15. If the work is an 'Artistic work', capable of being registered as a design under the Designs Act 2000. whether it has been applied to an article though an industrial process and ,if yes ,the number of times it is reproduced. : N.A.
16. Remarks, if any :

Diary Number : 1062/2019-CO/L
Date of Application : 23/01/2019
Date of Receipt : 23/01/2019

Dr. Shubha
2019

Extracts from the Register of Copyrights

Dated : 01/03/2019

1. Registration Number : L-81276/2019
2. Name, address and nationality of the applicant : KRISHNA INSTITUTE OF MEDICAL SCIENCES DEEMED TO BE UNIVERSITY , KRISHNA INSTITUTE OF MEDICAL SCIENCES DEEMED TO BE UNIVERSITY MALKAPUR, TAL. KARAD. DIST. - SATARA, MAHARASHTRA-415539 INDIAN
3. Nature of the applicant's interest in the copyright of the work : OWNER
4. Class and description of the work : LITERARY/ DRAMATIC WORK
5. Title of the work : PUSH TO SAVE TECHNIQUE
6. Language of the work : ENGLISH
7. Name, address and nationality of the author and if the author is deceased, date of his decease : DR. PRONOB SAIHYAL , HOD, PROFESSOR, SCHOOL OF DENTAL SCIENCES, KRISHNA INSTITUTE OF MEDICAL SCIENCES "DEEMED TO BE UNIVERSITY", MALKAPUR, TAL. KARAD, DIST. SATARA, MAHARASHTRA-415539 INDIAN
DR. SHUSHMA BOMANNAVAR , ASSISTANT PROFESSOR, SCHOOL OF DENTAL SCIENCES, KRISHNA INSTITUTE OF MEDICAL SCIENCES "DEEMED TO BE UNIVERSITY", MALKAPUR, TAL. KARAD, DIST SATARA, MAHARASHTRA-415539 INDIAN
DR. SHUBHA JOSHI , ASSOCIATE PROFESSOR, SCHOOL OF DENTAL SCIENCES, KRISHNA INSTITUTE OF MEDICAL SCIENCES "DEEMED TO BE UNIVERSITY", MALKAPUR, TAL. KARAD, DIST. SATARA, MAHARASHTRA-415539 INDIAN
8. Whether the work is published or unpublished : UNPUBLISHED
9. Year and country of first publication and name, address and nationality of the publisher : N.A.
10. Years and countries of subsequent publications, if any, and names, addresses and nationalities of the publishers : N.A.
11. Names, addresses and nationalities of the owners of various rights comprising the copyright in the work and the extent of rights held by each, together with particulars of assignments and licences, if any : KRISHNA INSTITUTE OF MEDICAL SCIENCES DEEMED TO BE UNIVERSITY , KRISHNA INSTITUTE OF MEDICAL SCIENCES DEEMED TO BE UNIVERSITY MALKAPUR, TAL. KARAD. DIST. - SATARA, MAHARASHTRA-415539 INDIAN
12. Names, addresses and nationalities of other persons, if any, authorised to assign or licence of rights comprising the copyright : N.A.
13. If the work is an 'Artistic work', the location of the original work, including name, address and nationality of the person in possession of the work. (In the case of an architectural work, the year of completion of the work should also be shown). : N.A.
14. If the work is an 'Artistic work', whether it is registered under the Designs Act 2000 if yes give details. : N.A.
15. If the work is an 'Artistic work', capable of being registered as a design under the Designs Act 2000, whether it has been applied to an article though an industrial process and, if yes, the number of times it is reproduced. : N.A.
16. Remarks, if any :



Extracts from the Register of Copyrights

Dated : 01/03/2019

1. Registration Number : **L-81247/2019**
2. Name, address and nationality of the applicant : KRISHNA INSTITUTE OF MEDICAL SCIENCES DEEMED TO BE UNIVERSITY , KRISHNA INSTITUTE OF MEDICAL SCIENCES "DEEMED TO BE UNIVERSITY", MALKAPUR, TAL. KARAD, DIST. SATARA, MAHARASHTRA-415539
INDIAN
3. Nature of the applicant's interest in the copyright of the work : OWNER
4. Class and description of the work : LITERARY/ DRAMATIC WORK
5. Title of the work : STUDENT SATISFACTION SURVEY FOR DENTAL INSTITUTE
6. Language of the work : ENGLISH
7. Name, address and nationality of the author and if the author is deceased, date of his decease : KRISHNA INSTITUTE OF MEDICAL SCIENCES DEEMED TO BE UNIVERSITY , KRISHNA INSTITUTE OF MEDICAL SCIENCES "DEEMED TO BE UNIVERSITY", MALKAPUR, TAL. KARAD, DIST. SATARA, MAHARASHTRA-415539
INDIAN
8. Whether the work is published or unpublished : UNPUBLISHED
9. Year and country of first publication and name, address and nationality of the publisher : N.A.
10. Years and countries of subsequent publications, if any, and names, addresses and nationalities of the publishers : N.A.
11. Names, addresses and nationalities of the owners of various rights comprising the copyright in the work and the extent of rights held by each, together with particulars of assignments and licences, if any : KRISHNA INSTITUTE OF MEDICAL SCIENCES DEEMED TO BE UNIVERSITY , KRISHNA INSTITUTE OF MEDICAL SCIENCES "DEEMED TO BE UNIVERSITY", MALKAPUR, TAL. KARAD, DIST. SATARA, MAHARASHTRA-415539
INDIAN
12. Names, addresses and nationalities of other persons, if any, authorised to assign or licence of rights comprising the copyright : N.A.
13. If the work is an 'Artistic work', the location of the original work, including name, address and nationality of the person in possession of the work. (In the case of an architectural work, the year of completion of the work should also be shown). : N.A.
14. If the work is an 'Artistic work', whether it is registered under the Designs Act 2000 if yes give details. : N.A.
15. If the work is an 'Artistic work', capable of being registered as a design under the Designs Act 2000, whether it has been applied to an article though an industrial process and, if yes, the number of times it is reproduced. : N.A.
16. Remarks, if any :

Diary Number : 1246/2019-CO/L
Date of Application : 26/01/2019
Date of Receipt : 26/01/2019

DEPUTY REGISTRAR OF COPYRIGHTS

Extracts from the Register of Copyrights

Dated : 11/03/2019

1. Registration Number : **L-81308/2019**
2. Name, address and nationality of the applicant : KRISHNA INSTITUTE OF MEDICAL SCIENCES "DEEMED TO BE UNIVERSITY", KARAD , KRISHNA INSTITUTE OF MEDICAL SCIENCES "DEEMED TO BE UNIVERSITY", MALKAPUR, TAL. KARAD, DIST. SATARA, MAHARASHTRA-415539 INDIAN
3. Nature of the applicant's interest in the copyright of the work : OWNER
4. Class and description of the work : LITERARY/ DRAMATIC WORK
5. Title of the work : PROCESS OF IMPROVING EYE-HAND COORDINATION
6. Language of the work : ENGLISH
7. Name, address and nationality of the author and if the author is deceased, date of his decease : DR. MUZAHID.K.SHEIKH , KRISHNA INSTITUTE OF MEDICAL SCIENCES "DEEMED TO BE UNIVERSITY", MALKAPUR, TAL. KARAD, DIST. SATARA, MAHARASHTRA-415539 INDIAN
8. Whether the work is published or unpublished : UNPUBLISHED
9. Year and country of first publication and name, address and nationality of the publisher : N.A.
10. Years and countries of subsequent publications, if any, and names, addresses and nationalities of the publishers : N.A.
11. Names, addresses and nationalities of the owners of various rights comprising the copyright in the work and the extent of rights held by each, together with particulars of assignments and licences, if any : KRISHNA INSTITUTE OF MEDICAL SCIENCES "DEEMED TO BE UNIVERSITY", KARAD , KRISHNA INSTITUTE OF MEDICAL SCIENCES "DEEMED TO BE UNIVERSITY", MALKAPUR, TAL. KARAD, DIST. SATARA, MAHARASHTRA-415539 INDIAN
12. Names, addresses and nationalities of other persons, if any, authorised to assign or licence of rights comprising the copyright : N.A.
13. If the work is an 'Artistic work', the location of the original work, including name, address and nationality of the person in possession of the work. (In the case of an architectural work, the year of completion of the work should also be shown). : N.A.
14. If the work is an 'Artistic work', whether it is registered under the Designs Act 2000 if yes give details. : N.A.
15. If the work is an 'Artistic work', capable of being registered as a design under the Designs Act 2000.whether it has been applied to an article though an industrial process and ,if yes ,the number of times it is reproduced. : N.A.
16. Remarks, if any :

Diary Number : 1247/2019-CO/L
Date of Application : 26/01/2019
Date of Receipt : 26/01/2019

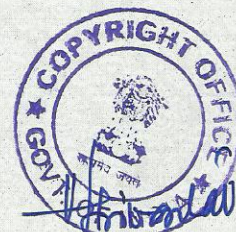

DEPUTY REGISTRAR OF COPYRIGHTS



Dated : 19/03/2019

1. Registration Number : **L-81431/2019**
2. Name, address and nationality of the applicant : KRISHNA INSTITUTE OF MEDICAL SCIENCES DEEMED TO BE UNIVERSITY, THROUGH REGISTRAR DR. M. V. GHORPADE , KRISHNA INSTITUTE OF MEDICAL SCIENCES DEEMED TO BE UNIVERSITY, NEAR DHEBEWADI ROAD, MALKAPUR TAL – KARAD. PIN – 415539 DIST. – SATARA, MAHARASHTRA, INDIA-415539INDIAN
3. Nature of the applicant's interest in the copyright of the work : OWNER
4. Class and description of the work : LITERARY/ DRAMATIC WORK
5. Title of the work : HOSPITAL DRUG FORMULARY
6. Language of the work : ENGLISH
7. Name, address and nationality of the author and if the author is deceased, date of his decease : DR. VANDANA M. THORAT , KRISHNA INSTITUTE OF MEDICAL SCIENCES DEEMED TO BE UNIVERSITY, PROFESSOR DEPARTMENT OF PHARMACOLOGY, NEAR DHEBEWADI ROAD, MALKAPUR TAL – KARAD. PIN – 415539 DIST. – SATARA, MAHARASHTRA, INDIA-415539INDIAN
8. Whether the work is published or unpublished : PUBLISHED
9. Year and country of first publication and name, address and nationality of the publisher : 2018 INDIAKRISHNA INSTITUTE OF MEDICAL SCIENCES DEEMED TO BE UNIVERSITY, THROUGH REGISTRAR DR. M. V. GHORPADE , KRISHNA INSTITUTE OF MEDICAL SCIENCES DEEMED TO BE UNIVERSITY, NEAR DHEBEWADI ROAD, MALKAPUR TAL – KARAD. PIN – 415539INDIAN
10. Years and countries of subsequent publications, if any, and names, addresses and nationalities of the publishers : N.A.
11. Names, addresses and nationalities of the owners of various rights comprising the copyright in the work and the extent of rights held by each, together with particulars of assignments and licences, if any : KRISHNA INSTITUTE OF MEDICAL SCIENCES DEEMED TO BE UNIVERSITY, THROUGH REGISTRAR DR. M. V. GHORPADE , KRISHNA INSTITUTE OF MEDICAL SCIENCES DEEMED TO BE UNIVERSITY, NEAR DHEBEWADI ROAD, MALKAPUR TAL – KARAD. PIN – 415539 DIST. – SATARA, MAHARASHTRA, INDIA-415539INDIAN
12. Names, addresses and nationalities of other persons, if any, authorised to assign or licence of rights comprising the copyright : KRISHNA INSTITUTE OF MEDICAL SCIENCES DEEMED TO BE UNIVERSITY, THROUGH REGISTRAR DR. M. V. GHORPADE , KRISHNA INSTITUTE OF MEDICAL SCIENCES DEEMED TO BE UNIVERSITY, NEAR DHEBEWADI ROAD, MALKAPUR TAL – KARAD. PIN – 415539 DIST. – SATARA, MAHARASHTRA, INDIA-415539INDIAN
13. If the work is an 'Artistic work', the location of the original work, including name, address and nationality of the person in possession of the work. (In the case of an architectural work, the year of completion of the work should also be shown). : N.A.
14. If the work is an 'Artistic work', whether it is registered under the Designs Act 2000 if yes give details. : N.A.
15. If the work is an 'Artistic work', capable of being registered as a design under the Designs Act 2000.whether it has been applied to an article though an industrial process and ,if yes ,the number of times it is reproduced. : N.A.
16. Remarks, if any :

Diary No. 15076/2018-CO/L
Date 31/10/2018
31/10/2018



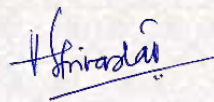

DEPUTY REGISTRAR OF COPYRIGHTS



Dated : 11/04/2019

1. Registration Number : **L-81530/2019**
2. Name, address and nationality of the applicant : KRISHNA INSTITUTE OF MEDICAL SCIENCES DEEMED TO BE UNIVERSITY, THROUGH REGISTRAR DR. M. V. GHORP, KRISHNA INSTITUTE OF MEDICAL SCIENCES DEEMED TO BE UNIVERSITY, NEAR DHEBEWADI ROAD, MALKAPUR TAL – KARAD. PIN – 415539 DIST. – SATARA, MAHARASHTRA, INDIA-415539INDIAN
3. Nature of the applicant's interest in the copyright of the work : OWNER
4. Class and description of the work : LITERARY/ DRAMATIC WORK ANTHROPOMETRIC GROWTH CHARTS
5. Title of the work : GROWTH CHARTS FOR HEIGHT, WEIGHT AND BODY MASS INDEX (BMI) FOR SCHOOL GOING ADOLESCENTS OF SATARA DISTRICT
6. Language of the work : ENGLISH
7. Name, address and nationality of the author and if the author is deceased, date of his decease : DR. P. M. DURGAWALE, PROFESSOR & HEAD, DEPARTMENT OF COMMUNITY MEDICINE, KRISHNA INSTITUTE OF MEDICAL SCIENCES, NEAR DHEBEWADI ROAD, MALKAPUR, TAL – KARAD. PIN – 415539, DIST. – SATARA, MAHARASHTRA, INDIA-415539INDIAN.
SATISH R. PATIL, PROFESSOR, DEPARTMENT OF MICROBIOLOGY, KRISHNA INSTITUTE OF MEDICAL SCIENCES, NEAR DHEBEWADI ROAD, MALKAPUR, TAL – KARAD. PIN – 415539, DIST. – SATARA, MAHARASHTRA, INDIA-415539INDIAN.
SUPRIYA SATISH PATIL, ASSO. PROFESSOR, DEPARTMENT OF COMMUNITY MEDICINE, DEAN ACADEMICS, KRISHNA INSTITUTE OF MEDICAL SCIENCES, NEAR DHEBEWADI ROAD, MALKAPUR, TAL – KARAD. PIN – 415539, DIST. – SATARA, MAHARASHTRA, INDIA-415539INDIAN
8. Whether the work is published or unpublished : UNPUBLISHED
9. Year and country of first publication and name, address and nationality of the publisher : N.A.
10. Years and countries of subsequent publications, if any, and names, addresses and nationalities of the publishers : N.A.
11. Names, addresses and nationalities of the owners of various rights comprising the copyright in the work and the extent of rights held by each, together with particulars of assignments and licences, if any : KRISHNA INSTITUTE OF MEDICAL SCIENCES DEEMED TO BE UNIVERSITY, THROUGH REGISTRAR DR. M. V. GHORP, KRISHNA INSTITUTE OF MEDICAL SCIENCES DEEMED TO BE UNIVERSITY, NEAR DHEBEWADI ROAD, MALKAPUR TAL – KARAD. PIN – 415539 DIST. – SATARA, MAHARASHTRA, INDIA-415539INDIAN
12. Names, addresses and nationalities of other persons, if any, authorised to assign or licence of rights comprising the copyright : KRISHNA INSTITUTE OF MEDICAL SCIENCES DEEMED TO BE UNIVERSITY, THROUGH REGISTRAR DR. M. V. GHORP, KRISHNA INSTITUTE OF MEDICAL SCIENCES DEEMED TO BE UNIVERSITY, NEAR DHEBEWADI ROAD, MALKAPUR TAL – KARAD. PIN – 415539 DIST. – SATARA, MAHARASHTRA, INDIA-415539INDIAN
13. If the work is an 'Artistic work', the location of the original work, including name, address and nationality of the person in possession of the work. (In the case of an architectural work, the year of completion of the work should also be shown). : N.A.
14. If the work is an 'Artistic work', whether it is registered under the Designs Act 2000 if yes give details. : N.A.
15. If the work is an 'Artistic work', capable of being registered as a design under the Designs Act 2000, whether it has been applied to an article, and if yes, the number of times : N.A.
16. :



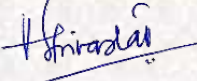

15072/2018-CO/L
Date of Registration : 31/10/2018
Date of Receipt : 31/10/2018

DEPUTY REGISTRAR OF COPYRIGHTS

Dated : 24/04/2019

1. Registration Number : **L-81658/2019**
2. Name, address and nationality of the applicant : KRISHNA INSTITUTE OF MEDICAL SCIENCES "DEEMED TO BE UNIVERSITY", KARAD. , NH4, PUNE - BANGALORE HIGHWAY, DIST.SATARA, AGASHIVNAGAR, MALKAPUR, MAHARASHTRA-415539
INDIAN
3. Nature of the applicant's interest in the copyright of the work : OWNER
4. Class and description of the work : LITERARY/ DRAMATIC WORK
5. Title of the work : PHYTOREMEDIATION : AN OVERVIEW
6. Language of the work : ENGLISH
7. Name, address and nationality of the author and if the author is deceased, date of his decease : MISS. JOTSNA MOHANLAL GANDHI , NH4, PUNE - BANGALORE HIGHWAY, DIST.SATARA, AGASHIVNAGAR, MALKAPUR, MAHARASHTRA-415539
INDIAN
8. Whether the work is published or unpublished : UNPUBLISHED
9. Year and country of first publication and name, address and nationality of the publisher : N.A.
10. Years and countries of subsequent publications, if any, and names, addresses and nationalities of the publishers : N.A.
11. Names, addresses and nationalities of the owners of various rights comprising the copyright in the work and the extent of rights held by each, together with particulars of assignments and licences, if any : KRISHNA INSTITUTE OF MEDICAL SCIENCES "DEEMED TO BE UNIVERSITY", KARAD. , NH4, PUNE - BANGALORE HIGHWAY, DIST.SATARA, AGASHIVNAGAR, MALKAPUR, MAHARASHTRA-415539
INDIAN
12. Names, addresses and nationalities of other persons, if any, authorised to assign or licence of rights comprising the copyright : KRISHNA INSTITUTE OF MEDICAL SCIENCES "DEEMED TO BE UNIVERSITY", KARAD. , NH4, PUNE - BANGALORE HIGHWAY, DIST.SATARA, AGASHIVNAGAR, MALKAPUR, MAHARASHTRA-415539
INDIAN
13. If the work is an 'Artistic work', the location of the original work, including name, address and nationality of the person in possession of the work. (In the case of an architectural work, the year of completion of the work should also be shown). : N.A.
14. If the work is an 'Artistic work', whether it is registered under the Designs Act 2000 if yes give details. : N.A.
15. If the work is an 'Artistic work', capable of being registered as a design under the Designs Act 2000.whether it has been applied to an article though an industrial process and ,if yes ,the number of times it is reproduced. : N.A.

Extracts from the Register of Copyrights

Dated : 25/04/2019

1. Registration Number : **L-81710/2019**
2. Name, address and nationality of the applicant : KRISHNA INSTITUTE OF MEDICAL SCIENCES "DEEMED TO BE UNIVERSITY", KARAD , NH4, PUNE - BANGALORE HIGHWAY, DIST.SATARA, AGASHIVNAGAR, MALKAPUR, MAHARASHTRA-415539
INDIAN
3. Nature of the applicant's interest in the copyright of the work : OWNER
4. Class and description of the work : LITERARY/ DRAMATIC WORK
5. Title of the work : QUESTIONNAIRE FOR ASSESSMENT OF KNOWLEDGE AND AWARENESS OF PATIENTS/CAREGIVERS ABOUT STROKE
6. Language of the work : ENGLISH
7. Name, address and nationality of the author and if the author is deceased, date of his decease : JISHA ANNIE GEEVARGHESE , NH4, PUNE - BANGALORE HIGHWAY, DIST.SATARA, AGASHIVNAGAR, MALKAPUR, MAHARASHTRA-415539
INDIAN
8. Whether the work is published or unpublished : UNPUBLISHED
9. Year and country of first publication and name, address and nationality of the publisher : N.A.
10. Years and countries of subsequent publications, if any, and names, addresses and nationalities of the publishers : N.A.
11. Names, addresses and nationalities of the owners of various rights comprising the copyright in the work and the extent of rights held by each, together with particulars of assignments and licences, if any : KRISHNA INSTITUTE OF MEDICAL SCIENCES "DEEMED TO BE UNIVERSITY", KARAD , NH4, PUNE - BANGALORE HIGHWAY, DIST.SATARA, AGASHIVNAGAR, MALKAPUR, MAHARASHTRA-415539
INDIAN
12. Names, addresses and nationalities of other persons, if any, authorised to assign or licence of rights comprising the copyright : KRISHNA INSTITUTE OF MEDICAL SCIENCES "DEEMED TO BE UNIVERSITY", KARAD , NH4, PUNE - BANGALORE HIGHWAY, DIST.SATARA, AGASHIVNAGAR, MALKAPUR, MAHARASHTRA-415539
INDIAN
13. If the work is an 'Artistic work', the location of the original work, including name, address and nationality of the person in possession of the work. (In the case of an architectural work, the year of completion of the work should also be shown). : N.A.
14. If the work is an 'Artistic work' which is used or capable of being used in relation to any goods or services, the application should include a certification from the Registrar of Trade Marks in terms of the provision to Sub-Section (i) of Section 45 of the Copyright Act, 1957 : N.A.
15. If the work is an 'Artistic work', whether it is registered under the Designs Act 2000 if yes give details. : N.A.
16. If the work is an 'Artistic work', capable of being registered as a design under the Designs Act 2000.whether it has been applied to an article though an industrial process and if yes, the number of times it is reproduced. : N.A.

Dated : 29/04/2019

1. Registration Number : **L-81857/2019**
 2. Name, address and nationality of the applicant : KRISHNA INSTITUTE OF MEDICAL SCIENCES "DEEMED TO BE UNIVERSITY", KARAD , KRISHNA INSTITUTE OF MEDICAL SCIENCES "DEEMED TO BE UNIVERSITY", KARAD, MALKAPUR, KARAD, DIST. SATARA, MAHARASHTRA, INDIA-415539
INDIAN
 3. Nature of the applicant's interest in the copyright of the work : OWNER
 4. Class and description of the work : LITERARY/ DRAMATIC WORK
 5. Title of the work : CONCISE BIOCHEMISTRY FOR NURSING
 6. Language of the work : ENGLISH
 7. Name, address and nationality of the author and if the author is deceased, date of his decease : DR. SANGITA PATIL , DEPARTMENT OF BIOCHEMISTRY, KRISHNA INSTITUTE OF MEDICAL SCIENCES "DEEMED TO BE UNIVERSITY", KARAD, MALKAPUR, KARAD, DIST. SATARA, MAHARASHTRA, INDIA-415539
INDIAN
DR. AJIT SONTAKKE , DEPARTMENT OF BIOCHEMISTRY, KRISHNA INSTITUTE OF MEDICAL SCIENCES "DEEMED TO BE UNIVERSITY", KARAD, MALKAPUR, KARAD, DIST. SATARA, MAHARASHTRA, INDIA-415539
INDIAN
 8. Whether the work is published or unpublished : UNPUBLISHED
 9. Year and country of first publication and name, address and nationality of the publisher : N.A.
 10. Years and countries of subsequent publications, if any, and names, addresses and nationalities of the publishers : N.A.
 11. Names, addresses and nationalities of the owners of various rights comprising the copyright in the work and the extent of rights held by each, together with particulars of assignments and licences, if any : KRISHNA INSTITUTE OF MEDICAL SCIENCES "DEEMED TO BE UNIVERSITY", KARAD , KRISHNA INSTITUTE OF MEDICAL SCIENCES "DEEMED TO BE UNIVERSITY", KARAD, MALKAPUR, KARAD, DIST. SATARA, MAHARASHTRA, INDIA-415539
INDIAN
 12. Names, addresses and nationalities of other persons, if any, authorised to assign or licence of rights comprising the copyright : N.A.
 13. If the work is an 'Artistic work', the location of the original work, including name, address and nationality of the person in possession of the work. (In the case of an architectural work, the year of completion of the work should also be shown). : N.A.
 14. If the work is an 'Artistic work', whether it is registered under the Designs Act 2000 if yes give details. : N.A.
 15. If the work is an 'Artistic work', capable of being registered as a design under the Designs Act 2000, whether it has been applied to an article though an industrial process and ,if yes ,the number of times it is reproduced. : N.A.
 16. Remarks, if any :
- Diary Number : 2180/2019-CO/L
Date of Application : 09/02/2019
Date of Receipt : 09/02/2019

उप पंजीयन अधिकारी प्रतिलिप्याधिकार
Deputy Registrar of Copyright

DEPUTY REGISTRAR OF COPYRIGHTS



Dated : 23/04/2019

1. Registration Number : **L-81604/2019**
2. Name, address and nationality of the applicant : KRISHNA INSTITUTE OF MEDICAL SCIENCES "DEEMED TO BE UNIVERSITY", KARAD , NH4, PUNE - BANGALORE HIGHWAY, DIST.SATARA, AGASHIVNAGAR, MALKAPUR, MAHARASHTRA-415539 INDIAN
3. Nature of the applicant's interest in the copyright of the work : OWNER
4. Class and description of the work : LITERARY/ DRAMATIC WORK
5. Title of the work : CONCEPT OF HYBRIDISATION
6. Language of the work : ENGLISH
7. Name, address and nationality of the author and if the author is deceased, date of his decease : DR. AMOL S. SHETE , NH4, PUNE - BANGALORE HIGHWAY, DIST.SATARA, AGASHIVNAGAR, MALKAPUR, MAHARASHTRA-415539 INDIAN
MS. SUPRIYA NANDKUMAR MANDRUPKAR , NH4, PUNE - BANGALORE HIGHWAY, DIST.SATARA, AGASHIVNAGAR, MALKAPUR, MAHARASHTRA-415539 INDIAN
MRS. AKSHADA A. KOPARDE , NH4, PUNE - BANGALORE HIGHWAY, DIST.SATARA, AGASHIVNAGAR, MALKAPUR, MAHARASHTRA-415539 INDIAN
DR. R. C. DOIJAD , NH4, PUNE - BANGALORE HIGHWAY, DIST.SATARA, AGASHIVNAGAR, MALKAPUR, MAHARASHTRA-415539 INDIAN
8. Whether the work is published or unpublished : UNPUBLISHED
9. Year and country of first publication and name, address and nationality of the publisher : N.A.
10. Years and countries of subsequent publications, if any, and names, addresses and nationalities of the publishers : N.A.
11. Names, addresses and nationalities of the owners of various rights comprising the copyright in the work and the extent of rights held by each, together with particulars of assignments and licences, if any : KRISHNA INSTITUTE OF MEDICAL SCIENCES "DEEMED TO BE UNIVERSITY", KARAD , NH4, PUNE - BANGALORE HIGHWAY, DIST.SATARA, AGASHIVNAGAR, MALKAPUR, MAHARASHTRA-415539 INDIAN
12. Names, addresses and nationalities of other persons, if any, authorised to assign or licence of rights comprising the copyright : KRISHNA INSTITUTE OF MEDICAL SCIENCES "DEEMED TO BE UNIVERSITY", KARAD , NH4, PUNE - BANGALORE HIGHWAY, DIST.SATARA, AGASHIVNAGAR, MALKAPUR, MAHARASHTRA-415539 INDIAN
13. If the work is an 'Artistic work', the location of the original work, including name, address and nationality of the person in possession of the work. (In the case of an architectural work, the year of completion of the work should also be shown). : N.A.
14. If the work is an 'Artistic work' which is used or capable of being used in relation to any goods or services, the application should include a certification from the Registrar of Trade Marks in terms of the provision to Sub-Section (i) of Section 45 of the Copyright Act, 1957 : N.A.
15. If the work is an 'Artistic work', whether it is registered under the Designs Act 2000 if yes give details. : N.A.
16. If the work is an 'Artistic work', capable of being registered as a design under the Designs Act 2000 whether it has been applied to an article though an industrial process and ,if yes ,the number of times it is reproduced. : N.A.
17. Remarks, if any :

Dated : 23/04/2019

1. Registration Number : **L-81622/2019**
2. Name, address and nationality of the applicant : KRISHNA INSTITUTE OF MEDICAL SCIENCES "DEEMED TO BE UNIVERSITY", KARAD , NH4, PUNE - BANGALORE HIGHWAY, DIST.SATARA, AGASHIVNAGAR, MALKAPUR, MAHARASHTRA-415539
INDIAN
3. Nature of the applicant's interest in the copyright of the work : OWNER
4. Class and description of the work : LITERARY/ DRAMATIC WORK
5. Title of the work : EVIDENCE BASED HOMEOPATHIC MEDICINE FOR TREATMENT FOR DEPRESSION
6. Language of the work : ENGLISH
7. Name, address and nationality of the author and if the author is deceased, date of his decease : MR. ANUP ASHOK PATIL , KRISHNA INSTITUTE OF MEDICAL SCIENCES "DEEMED TO BE UNIVERSITY", KARAD-415539
INDIAN
8. Whether the work is published or unpublished : UNPUBLISHED
9. Year and country of first publication and name, address and nationality of the publisher : N.A.
10. Years and countries of subsequent publications, if any, and names, addresses and nationalities of the publishers : N.A.
11. Names, addresses and nationalities of the owners of various rights comprising the copyright in the work and the extent of rights held by each, together with particulars of assignments and licences, if any : KRISHNA INSTITUTE OF MEDICAL SCIENCES "DEEMED TO BE UNIVERSITY", KARAD , NH4, PUNE - BANGALORE HIGHWAY, DIST.SATARA, AGASHIVNAGAR, MALKAPUR, MAHARASHTRA-415539
INDIAN
12. Names, addresses and nationalities of other persons, if any, authorised to assign or licence of rights comprising the copyright : KRISHNA INSTITUTE OF MEDICAL SCIENCES "DEEMED TO BE UNIVERSITY", KARAD , NH4, PUNE - BANGALORE HIGHWAY, DIST.SATARA, AGASHIVNAGAR, MALKAPUR, MAHARASHTRA-415539
INDIAN
13. If the work is an 'Artistic work', the location of the original work, including name, address and nationality of the person in possession of the work. (In the case of an architectural work, the year of completion of the work should also be shown). : N.A.
14. If the work is an 'Artistic work' which is used or capable of being used in relation to any goods or services, the application should include a certification from the Registrar of Trade Marks in terms of the provision to Sub-Section (i) of Section 45 of the Copyright Act, 1957 : N.A.
15. If the work is an 'Artistic work', whether it is registered under the Designs Act 2000 if yes give details. : N.A.
16. If the work is an 'Artistic work', capable of being registered as a design under the Designs Act 2000 whether it has been applied to an article though an

Dated : 02/05/2019

1. Registration Number : **L-81969/2019**
2. Name, address and nationality of the applicant : KRISHNA INSTITUTE OF MEDICAL SCIENCES "DEEMED TO BE UNIVERSITY", KARAD , KRISHNA INSTITUTE OF MEDICAL SCIENCES "DEEMED TO BE UNIVERSITY", KARAD, MALKAPUR, KARAD, DIST. SATARA, MAHARASHTRA, INDIA-415539
INDIAN
3. Nature of the applicant's interest in the copyright of the work : OWNER
4. Class and description of the work : LITERARY/ DRAMATIC WORK
5. Title of the work : FACTORS AFFECTING FOR FERTILITY RATE OF EVER MARRIED WOMEN OF INDIA
6. Language of the work : ENGLISH
7. Name, address and nationality of the author and if the author is deceased, date of his decease : DR. D. K. AGRAWAL , KRISHNA INSTITUTE OF MEDICAL SCIENCES "DEEMED TO BE UNIVERSITY", KARAD, MALKAPUR, KARAD, DIST. SATARA, MAHARASHTRA, INDIA-415539
INDIAN

DR. S. V. KAKADE , KRISHNA INSTITUTE OF MEDICAL SCIENCES "DEEMED TO BE UNIVERSITY", KARAD, MALKAPUR, KARAD, DIST. SATARA, MAHARASHTRA, INDIA-415539
INDIAN

MR. MAHENDRA ALATE , STATISTICIAN DIRECTOR OF RESEARCH OFFICE, KRISHNA INSTITUTE OF MEDICAL SCIENCES "DEEMED TO BE UNIVERSITY", KARAD, MALKAPUR, KARAD, DIST. SATARA, MAHARASHTRA, INDIA-415539
INDIAN

MR. DHIRAJKUMAR A. MANE PATIL , KRISHNA INSTITUTE OF MEDICAL SCIENCES "DEEMED TO BE UNIVERSITY", KARAD, MALKAPUR, KARAD, DIST. SATARA, MAHARASHTRA, INDIA-415539
INDIAN
8. Whether the work is published or unpublished : UNPUBLISHED
9. Year and country of first publication and name, address and nationality of the publisher : N.A.
10. Years and countries of subsequent publications, if any, and names, addresses and nationalities of the publishers : N.A.
11. Names, addresses and nationalities of the owners of various rights comprising the copyright in the work and the extent of rights held by each, together with particulars of assignments and licences, if any : KRISHNA INSTITUTE OF MEDICAL SCIENCES "DEEMED TO BE UNIVERSITY", KARAD , KRISHNA INSTITUTE OF MEDICAL SCIENCES "DEEMED TO BE UNIVERSITY", KARAD, MALKAPUR, KARAD, DIST. SATARA, MAHARASHTRA, INDIA-415539
INDIAN
12. Names, addresses and nationalities of other persons, if any, authorised to assign or licence of rights comprising the copyright : N.A.
13. If the work is an 'Artistic work', the location of the original work, including name, address and nationality of the person in possession of the work. (In the case of an architectural work, the year of completion of the work should also be shown). : N.A.
14. If the work is an 'Artistic work' which is used or capable of being used in relation to any goods or services, the application should include a certification from the Registrar of Trade Marks in terms of the provision to Sub-Section (i) of Section 45 of the Copyright Act, 1957 : N.A.
15. If the work is an 'Artistic work', whether it is registered under the Designs Act 2000 if yes give details. : N.A.
16. If the work is an 'Artistic work', capable of being registered as a design under the Designs Act 2000. whether it has been applied to an article though an industrial process and ,if yes ,the number of times it is reproduced. : N.A.





Dated : 08/05/2019

1. Registration Number : **L-82117/2019**
 2. Name, address and nationality of the applicant : KRISHNA INSTITUTE OF MEDICAL SCIENCES "DEEMED TO BE UNIVERSITY", KARAD , NH4, PUNE - BANGALORE HIGHWAY, DIST.SATARA, AGASHIVNAGAR, MALKAPUR, MAHARASHTRA-415539INDIAN
 3. Nature of the applicant's interest in the copyright of the work : OWNER
 4. Class and description of the work : LITERARY/ DRAMATIC WORK
 5. Title of the work : WARFARIN ANTICOAGULATION, ITS MECHANISM OF RESISTANCE AND MANAGEMENT
 6. Language of the work : ENGLISH
 7. Name, address and nationality of the author and if the author is deceased, date of his decease : MRS. JISHA ANNIE GEEVARGHESE , KRISHNA INSTITUTE OF MEDICAL SCIENCES "DEEMED TO BE UNIVERSITY", KARAD-415539INDIAN
 8. Whether the work is published or unpublished : UNPUBLISHED
 9. Year and country of first publication and name, address and nationality of the publisher : N.A.
 10. Years and countries of subsequent publications, if any, and names, addresses and nationalities of the publishers : N.A.
 11. Names, addresses and nationalities of the owners of various rights comprising the copyright in the work and the extent of rights held by each, together with particulars of assignments and licences, if any : KRISHNA INSTITUTE OF MEDICAL SCIENCES "DEEMED TO BE UNIVERSITY", KARAD , NH4, PUNE - BANGALORE HIGHWAY, DIST.SATARA, AGASHIVNAGAR, MALKAPUR, MAHARASHTRA-415539INDIAN
 12. Names, addresses and nationalities of other persons, if any, authorised to assign or licence of rights comprising the copyright : KRISHNA INSTITUTE OF MEDICAL SCIENCES "DEEMED TO BE UNIVERSITY", KARAD , NH4, PUNE - BANGALORE HIGHWAY, DIST.SATARA, AGASHIVNAGAR, MALKAPUR, MAHARASHTRA-415539INDIAN
 13. If the work is an 'Artistic work', the location of the original work, including name, address and nationality of the person in possession of the work. (In the case of an architectural work, the year of completion of the work should also be shown). : N.A.
 14. If the work is an 'Artistic work', whether it is registered under the Designs Act 2000 if yes give details. : N.A.
 15. If the work is an 'Artistic work', capable of being registered as a design under the Designs Act 2000.whether it has been applied to an article though an industrial process and ,if yes ,the number of times it is reproduced. : N.A.
 16. Remarks, if any :
- Diary Number : 2666/2019-CO/L
Date of Application : 18/02/2019
Date of Receipt : 18/02/2019



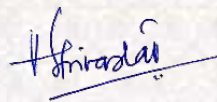

DEPUTY REGISTRAR OF COPYRIGHTS

Dated : 16/05/2019

1. Registration Number : **L-82510/2019**
2. Name, address and nationality of the applicant : KRISHNA INSTITUTE OF MEDICAL SCIENCES "DEEMED TO BE UNIVERSITY", KARAD , NH4, PUNE - BANGALORE HIGHWAY, DIST.SATARA, AGASHIVNAGAR, MALKAPUR, MAHARASHTRA-415539
INDIAN
3. Nature of the applicant's interest in the copyright of the work : OWNER
4. Class and description of the work : LITERARY/ DRAMATIC WORK
5. Title of the work : POLYMER MODIFICATION
6. Language of the work : ENGLISH
7. Name, address and nationality of the author and if the author is deceased, date of his decease : VISHAL VILAS SHAH , NH4, PUNE - BANGALORE HIGHWAY, DIST.SATARA, AGASHIVNAGAR, MALKAPUR, MAHARASHTRA-415539
INDIAN
8. Whether the work is published or unpublished : UNPUBLISHED
9. Year and country of first publication and name, address and nationality of the publisher : N.A.
10. Years and countries of subsequent publications, if any, and names, addresses and nationalities of the publishers : N.A.
11. Names, addresses and nationalities of the owners of various rights comprising the copyright in the work and the extent of rights held by each, together with particulars of assignments and licences, if any : KRISHNA INSTITUTE OF MEDICAL SCIENCES "DEEMED TO BE UNIVERSITY", KARAD , NH4, PUNE - BANGALORE HIGHWAY, DIST.SATARA, AGASHIVNAGAR, MALKAPUR, MAHARASHTRA-415539
INDIAN
12. Names, addresses and nationalities of other persons, if any, authorised to assign or licence of rights comprising the copyright : KRISHNA INSTITUTE OF MEDICAL SCIENCES "DEEMED TO BE UNIVERSITY", KARAD , NH4, PUNE - BANGALORE HIGHWAY, DIST.SATARA, AGASHIVNAGAR, MALKAPUR, MAHARASHTRA-415539
INDIAN
13. If the work is an 'Artistic work', the location of the original work, including name, address and nationality of the person in possession of the work. (In the case of an architectural work, the year of completion of the work should also be shown). : N.A.
14. If the work is an 'Artistic work' which is used or capable of being used in relation to any goods or services, the application should include a certification from the Registrar of Trade Marks in terms of the provision to Sub-Section (i) of Section 45 of the Copyright Act, 1957 : N.A.
15. If the work is an 'Artistic work', whether it is registered under the Designs Act 2000 if yes give details. : N.A.
16. If the work is an 'Artistic work', capable of being registered as a design under the Designs Act 2000 whether it has been applied to an article though an : N.A.





Dated : 17/05/2019

1. Registration Number : **L-82592/2019**
2. Name, address and nationality of the applicant : KRISHNA INSTITUTE OF MEDICAL SCIENCES "DEEMED TO BE UNIVERSITY", KARAD , KRISHNA INSTITUTE OF MEDICAL SCIENCES "DEEMED TO BE UNIVERSITY", KARAD, MALKAPUR, KARAD, DIST. SATARA, MAHARASHTRA, INDIA-415539INDIAN
3. Nature of the applicant's interest in the copyright of the work : OWNER
4. Class and description of the work : LITERARY/ DRAMATIC WORK
5. Title of the work : INTERPRETATION SCALE FOR LABOUR PAIN
6. Language of the work : ENGLISH
7. Name, address and nationality of the author and if the author is deceased, date of his decease : MRS. LEKSHMI SUDHISH NAIR , KRISHNA INSTITUTE OF NURSING SCIENCES, KRISHNA INSTITUTE OF MEDICAL SCIENCES "DEEMED TO BE UNIVERSITY", KARAD, MALKAPUR, DIST. SATARA, MAHARASHTRA , INDIA-415539INDIANMRS. FEBE RAJU , KRISHNA INSTITUTE OF NURSING SCIENCES, KRISHNA INSTITUTE OF MEDICAL SCIENCES "DEEMED TO BE UNIVERSITY", KARAD, MALKAPUR, DIST. SATARA, MAHARASHTRA , INDIA-415539INDIANDR. JYOTI SALUNKHE , KRISHNA INSTITUTE OF MEDICAL SCIENCES "DEEMED TO BE UNIVERSITY", KARAD, MALKAPUR, DIST. SATARA, MAHARASHTRA , INDIA-415539INDIAN
8. Whether the work is published or unpublished : UNPUBLISHED
9. Year and country of first publication and name, address and nationality of the publisher : N.A.
10. Years and countries of subsequent publications, if any, and names, addresses and nationalities of the publishers : N.A.
11. Names, addresses and nationalities of the owners of various rights comprising the copyright in the work and the extent of rights held by each, together with particulars of assignments and licences, if any : KRISHNA INSTITUTE OF MEDICAL SCIENCES "DEEMED TO BE UNIVERSITY", KARAD , KRISHNA INSTITUTE OF MEDICAL SCIENCES "DEEMED TO BE UNIVERSITY", KARAD, MALKAPUR, KARAD, DIST. SATARA, MAHARASHTRA, INDIA-415539INDIAN
12. Names, addresses and nationalities of other persons, if any, authorised to assign or licence of rights comprising the copyright : N.A.
13. If the work is an 'Artistic work', the location of the original work, including name, address and nationality of the person in possession of the work. (In the case of an architectural work, the year of completion of the work should also be shown). : N.A.
14. If the work is an 'Artistic work' which is used or capable of being used in relation to any goods or services, the application should include a certification from the Registrar of Trade Marks in terms of the provision to Sub-Section (i) of Section 45 of the Copyright Act, 1957. : N.A.
15. If the work is an 'Artistic work', whether it is registered under the Designs Act 2000 if yes give details. : N.A.
16. If the work is an 'Artistic work', capable of being registered as a design under the Designs Act 2000, whether it has been applied to an article or to an industrial process and ,if yes ,the number of times it is : N.A.
17. :



4909/2019-CO/L

01/04/2019

01/04/2019

DEPUTY REGISTRAR OF COPYRIGHTS



Dated : 28/05/2019

1. Registration Number : **L-82856/2019**
 2. Name, address and nationality of the applicant : KRISHNA INSTITUTE OF MEDICAL SCIENCES "DEEMED TO BE UNIVERSITY", KARAD , NH4, PUNE - BANGALORE HIGHWAY, DIST.SATARA, AGASHIVNAGAR, MALKAPUR, MAHARASHTRA-415539INDIAN
 3. Nature of the applicant's interest in the copyright of the work : OWNER
 4. Class and description of the work : LITERARY/ DRAMATIC WORK
 5. Title of the work : STRATEGIES AND PROCEDURE FOR OBTAINING NATURAL PRODUCTS IN DRUG DISCOVERY
 6. Language of the work : ENGLISH
 7. Name, address and nationality of the author and if the author is deceased, date of his decease : MRS. AKSHADA AMIT KOPARDE , KRISHNA INSTITUTE OF MEDICAL SCIENCES "DEEMED TO BE UNIVERSITY", KARAD-415539INDIANDR. R. C. DOJAD , KRISHNA INSTITUTE OF MEDICAL SCIENCES "DEEMED TO BE UNIVERSITY", KARAD-415539INDIAN
 8. Whether the work is published or unpublished : UNPUBLISHED
 9. Year and country of first publication and name, address and nationality of the publisher : N.A.
 10. Years and countries of subsequent publications, if any, and names, addresses and nationalities of the publishers : N.A.
 11. Names, addresses and nationalities of the owners of various rights comprising the copyright in the work and the extent of rights held by each, together with particulars of assignments and licences, if any : KRISHNA INSTITUTE OF MEDICAL SCIENCES "DEEMED TO BE UNIVERSITY", KARAD , NH4, PUNE - BANGALORE HIGHWAY, DIST.SATARA, AGASHIVNAGAR, MALKAPUR, MAHARASHTRA-415539INDIAN
 12. Names, addresses and nationalities of other persons, if any, authorised to assign or licence of rights comprising the copyright : N.A.
 13. If the work is an 'Artistic work', the location of the original work, including name, address and nationality of the person in possession of the work. (In the case of an architectural work, the year of completion of the work should also be shown). : N.A.
 14. If the work is an 'Artistic work', whether it is registered under the Designs Act 2000 if yes give details. : N.A.
 15. If the work is an 'Artistic work', capable of being registered as a design under the Designs Act 2000.whether it has been applied to an article though an industrial process and ,if yes ,the number of times it is reproduced. : N.A.
 16. Remarks, if any :
- Diary Number : 2650/2019-CO/L
Date of Application : 18/02/2019
Date of Receipt : 18/02/2019



H. Hiradai

DEPUTY REGISTRAR OF COPYRIGHTS



Dated : 29/05/2019

1. Registration Number : **L-82881/2019**
 2. Name, address and nationality of the applicant : KRISHNA INSTITUTE OF MEDICAL SCIENCES "DEEMED TO BE UNIVERSITY", KARAD. , NH4, PUNE - BANGALORE HIGHWAY, DIST.SATARA, AGASHIVNAGAR, MALKAPUR, MAHARASHTRA-415539INDIAN
 3. Nature of the applicant's interest in the copyright of the work : OWNER
 4. Class and description of the work : LITERARY/ DRAMATIC WORK
 5. Title of the work : MEDICAL CODING
 6. Language of the work : ENGLISH
 7. Name, address and nationality of the author and if the author is deceased, date of his decease : MRS.SWATI BABASO UDUGADE , NH4, PUNE - BANGALORE HIGHWAY, DIST.SATARA, AGASHIVNAGAR, MALKAPUR, MAHARASHTRA-415539INDIAN
 8. Whether the work is published or unpublished : UNPUBLISHED
 9. Year and country of first publication and name, address and nationality of the publisher : N.A.
 10. Years and countries of subsequent publications, if any, and names, addresses and nationalities of the publishers : N.A.
 11. Names, addresses and nationalities of the owners of various rights comprising the copyright in the work and the extent of rights held by each, together with particulars of assignments and licences, if any : KRISHNA INSTITUTE OF MEDICAL SCIENCES "DEEMED TO BE UNIVERSITY", KARAD. , NH4, PUNE - BANGALORE HIGHWAY, DIST.SATARA, AGASHIVNAGAR, MALKAPUR, MAHARASHTRA-415539INDIAN
 12. Names, addresses and nationalities of other persons, if any, authorised to assign or licence of rights comprising the copyright : KRISHNA INSTITUTE OF MEDICAL SCIENCES "DEEMED TO BE UNIVERSITY", KARAD. , NH4, PUNE - BANGALORE HIGHWAY, DIST.SATARA, AGASHIVNAGAR, MALKAPUR, MAHARASHTRA-415539INDIAN
 13. If the work is an 'Artistic work', the location of the original work, including name, address and nationality of the person in possession of the work. (In the case of an architectural work, the year of completion of the work should also be shown). : N.A.
 14. If the work is an 'Artistic work', whether it is registered under the Designs Act 2000 if yes give details. : N.A.
 15. If the work is an 'Artistic work', capable of being registered as a design under the Designs Act 2000.whether it has been applied to an article though an industrial process and ,if yes ,the number of times it is reproduced. : N.A.
 16. Remarks, if any :
- Diary Number : 2681/2019-CO/L
Date of Application : 18/02/2019
Date of Receipt : 18/02/2019



H. Hiradai

DEPUTY REGISTRAR OF COPYRIGHTS



Dated : 16/05/2019

- | | | |
|--|---|--|
| 1. Registration Number | : | L-82527/2019 |
| 2. Name, address and nationality of the applicant | : | KRISHNA INSTITUTE OF MEDICAL SCIENCES "DEEMED TO BE UNIVERSITY", KARAD , KRISHNA INSTITUTE OF MEDICAL SCIENCES "DEEMED TO BE UNIVERSITY", KARAD, MALKAPUR, KARAD, DIST. SATARA, MAHARASHTRA, INDIA-415539INDIAN |
| 3. Nature of the applicant's interest in the copyright of the work | : | OWNER |
| 4. Class and description of the work | : | LITERARY/ DRAMATIC WORK |
| 5. Title of the work | : | PARTURIENCE EXPERIENCE QUESTIONNAIRE |
| 6. Language of the work | : | ENGLISH |
| 7. Name, address and nationality of the author and if the author is deceased, date of his decease | : | MRS. LEKSHMI SUDHISH NAIR , KRISHNA INSTITUTE OF NURSING SCIENCES, KRISHNA INSTITUTE OF MEDICAL SCIENCES "DEEMED TO BE UNIVERSITY", KARAD, MALKAPUR, DIST. SATARA, MAHARASHTRA , INDIA-415539INDIANMRS. FEBA RAJU , KRISHNA INSTITUTE OF NURSING SCIENCES, KRISHNA INSTITUTE OF MEDICAL SCIENCES "DEEMED TO BE UNIVERSITY", KARAD, MALKAPUR, DIST. SATARA, MAHARASHTRA , INDIA-415539INDIANDR. MRS. JYOTI A SALUNKHE , KRISHNA INSTITUTE OF NURSING SCIENCES, KRISHNA INSTITUTE OF MEDICAL SCIENCES "DEEMED TO BE UNIVERSITY", KARAD, MALKAPUR, DIST. SATARA, MAHARASHTRA , INDIA-415539INDIAN |
| 8. Whether the work is published or unpublished | : | UNPUBLISHED |
| 9. Year and country of first publication and name, address and nationality of the publisher | : | N.A. |
| 10. Years and countries of subsequent publications, if any, and names, addresses and nationalities of the publishers | : | N.A. |
| 11. Names, addresses and nationalities of the owners of various rights comprising the copyright in the work and the extent of rights held by each, together with particulars of assignments and licences, if any | : | KRISHNA INSTITUTE OF MEDICAL SCIENCES "DEEMED TO BE UNIVERSITY", KARAD , KRISHNA INSTITUTE OF MEDICAL SCIENCES "DEEMED TO BE UNIVERSITY", KARAD, MALKAPUR, KARAD, DIST. SATARA, MAHARASHTRA, INDIA-415539INDIAN |
| 12. Names, addresses and nationalities of other persons, if any, authorised to assign or licence of rights comprising the copyright | : | N.A. |
| 13. If the work is an 'Artistic work', the location of the original work, including name, address and nationality of the person in possession of the work. (In the case of an architectural work, the year of completion of the work should also be shown). | : | N.A. |
| 14. If the work is an 'Artistic work' which is used or capable of being used in relation to any goods or services, the application should include a certification from the Registrar of Trade Marks in terms of the provision to Sub-Section (i) of Section 45 of the Copyright Act, 1957. | : | N.A. |
| 15. If the work is an 'Artistic work', whether it is registered under the Designs Act 2000 if yes give details. | : | N.A. |
| 16. If the work is an 'Artistic work', capable of being registered as a design under the Designs Act 2000.whether it has been applied to an article though an industrial process and ,if yes ,the number of times it is registered | : | N.A. |
| 17. F | : | |



4984/2019-CO/L
02/04/2019
02/04/2019

DEPUTY REGISTRAR OF COPYRIGHTS



Dated : 17/05/2019

1. Registration Number : **L-82595/2019**
2. Name, address and nationality of the applicant : KRISHNA INSTITUTE OF MEDICAL SCIENCES "DEEMED TO BE UNIVERSITY", KARAD , KRISHNA INSTITUTE OF MEDICAL SCIENCES "DEEMED TO BE UNIVERSITY", KARAD, MALKAPUR, KARAD, DIST. SATARA, MAHARASHTRA, INDIA-415539INDIAN
3. Nature of the applicant's interest in the copyright of the work : OWNER
4. Class and description of the work : LITERARY/ DRAMATIC WORK
5. Title of the work : EFFECTIVENESS OF BEHAVIOR MODIFICATION STRATEGIES IN SCHOOL GOING CHILDREN FOR SPECIFIC CLASSROOM BEHAVIOR
6. Language of the work : ENGLISH
7. Name, address and nationality of the author and if the author is deceased, date of his decease : MR. MANDAR MALAWADE , KRISHNA INSTITUTE OF MEDICAL SCIENCES "DEEMED TO BE UNIVERSITY", KARAD, MALKAPUR, DIST. SATARA, MAHARASHTRA , INDIA-415539INDIAN
8. Whether the work is published or unpublished : UNPUBLISHED
9. Year and country of first publication and name, address and nationality of the publisher : N.A.
10. Years and countries of subsequent publications, if any, and names, addresses and nationalities of the publishers : N.A.
11. Names, addresses and nationalities of the owners of various rights comprising the copyright in the work and the extent of rights held by each, together with particulars of assignments and licences, if any : KRISHNA INSTITUTE OF MEDICAL SCIENCES "DEEMED TO BE UNIVERSITY", KARAD , KRISHNA INSTITUTE OF MEDICAL SCIENCES "DEEMED TO BE UNIVERSITY", KARAD, MALKAPUR, KARAD, DIST. SATARA, MAHARASHTRA, INDIA-415539INDIAN
12. Names, addresses and nationalities of other persons, if any, authorised to assign or licence of rights comprising the copyright : N.A.
13. If the work is an 'Artistic work', the location of the original work, including name, address and nationality of the person in possession of the work. (In the case of an architectural work, the year of completion of the work should also be shown). : N.A.
14. If the work is an 'Artistic work' which is used or capable of being used in relation to any goods or services, the application should include a certification from the Registrar of Trade Marks in terms of the provision to Sub-Section (i) of Section 45 of the Copyright Act, 1957. : N.A.
15. If the work is an 'Artistic work', whether it is registered under the Designs Act 2000 if yes give details. : N.A.
16. If the work is an 'Artistic work', capable of being registered as a design under the Designs Act 2000, whether it has been applied to an article through an industrial process and ,if yes ,the number of times it is reproduced. : N.A.
17. Remarks, if any :

Diary Number : 5510/2019-CO/L

Date of Application : 11/04/2019

Date of Registration : 11/04/2019



DEPUTY REGISTRAR OF COPYRIGHTS



Dated : 17/05/2019

1. Registration Number : **L-82596/2019**
2. Name, address and nationality of the applicant : KRISHNA INSTITUTE OF MEDICAL SCIENCES "DEEMED TO BE UNIVERSITY", KARAD , KRISHNA INSTITUTE OF MEDICAL SCIENCES "DEEMED TO BE UNIVERSITY", KARAD, MALKAPUR, KARAD, DIST. SATARA, MAHARASHTRA, INDIA-415539INDIAN
3. Nature of the applicant's interest in the copyright of the work : OWNER
4. Class and description of the work : LITERARY/ DRAMATIC WORK
5. Title of the work : TRANSTHORACIC TWO- DIMENSIONAL ECHOCARDIOGRAM AND DOPPLER REPORT TEMPLATE
6. Language of the work : ENGLISH
7. Name, address and nationality of the author and if the author is deceased, date of his decease : DR. VIRENDRA CHANDRASHEKHAR PATIL , KRISHNA INSTITUTE OF MEDICAL SCIENCES "DEEMED TO BE UNIVERSITY", KARAD, MALKAPUR, DIST. SATARA, MAHARASHTRA , INDIA-415539INDIAN
8. Whether the work is published or unpublished : UNPUBLISHED
9. Year and country of first publication and name, address and nationality of the publisher : N.A.
10. Years and countries of subsequent publications, if any, and names, addresses and nationalities of the publishers : N.A.
11. Names, addresses and nationalities of the owners of various rights comprising the copyright in the work and the extent of rights held by each, together with particulars of assignments and licences, if any : KRISHNA INSTITUTE OF MEDICAL SCIENCES "DEEMED TO BE UNIVERSITY", KARAD , KRISHNA INSTITUTE OF MEDICAL SCIENCES "DEEMED TO BE UNIVERSITY", KARAD, MALKAPUR, KARAD, DIST. SATARA, MAHARASHTRA, INDIA-415539INDIAN
12. Names, addresses and nationalities of other persons, if any, authorised to assign or licence of rights comprising the copyright : N.A.
13. If the work is an 'Artistic work', the location of the original work, including name, address and nationality of the person in possession of the work. (In the case of an architectural work, the year of completion of the work should also be shown). : N.A.
14. If the work is an 'Artistic work' which is used or capable of being used in relation to any goods or services, the application should include a certification from the Registrar of Trade Marks in terms of the provision to Sub-Section (i) of Section 45 of the Copyright Act, 1957. : N.A.
15. If the work is an 'Artistic work', whether it is registered under the Designs Act 2000 if yes give details. : N.A.
16. If the work is an 'Artistic work', capable of being registered as a design under the Designs Act 2000.whether it has been applied to an article though an industrial process and ,if yes ,the number of times it is reproduced. : N.A.
17. Remarks, if any :

Diary Number : 5530/2019-CO/L

Date of Application : 11/04/2019

Date : 11/04/2019



DEPUTY REGISTRAR OF COPYRIGHTS



Dated : 21/05/2019

1. Registration Number : **L-82620/2019**
2. Name, address and nationality of the applicant : KRISHNA INSTITUTE OF MEDICAL SCIENCES "DEEMED TO BE UNIVERSITY", KARAD , KRISHNA INSTITUTE OF MEDICAL SCIENCES "DEEMED TO BE UNIVERSITY", KARAD, MALKAPUR, KARAD, DIST. SATARA, MAHARASHTRA, INDIA-415539INDIAN
3. Nature of the applicant's interest in the copyright of the work : OWNER
4. Class and description of the work : LITERARY/ DRAMATIC WORK
5. Title of the work : MATERNAL OUTCOME SCALE FOR LABOUR PAIN
6. Language of the work : ENGLISH
7. Name, address and nationality of the author and if the author is deceased, date of his decease : MRS. LEKSHMI SUDHISH NAIR , KRISHNA INSTITUTE OF NURSING SCIENCES, KRISHNA INSTITUTE OF MEDICAL SCIENCES "DEEMED TO BE UNIVERSITY", KARAD, MALKAPUR, DIST. SATARA, MAHARASHTRA , INDIA-415539INDIANMRS. FEBBA RAJU , KRISHNA INSTITUTE OF NURSING SCIENCES, KRISHNA INSTITUTE OF MEDICAL SCIENCES "DEEMED TO BE UNIVERSITY", KARAD, MALKAPUR, DIST. SATARA, MAHARASHTRA , INDIA-415539INDIANDR. MRS. JYOTI A SALUNKHE , KRISHNA INSTITUTE OF NURSING SCIENCES, KRISHNA INSTITUTE OF MEDICAL SCIENCES "DEEMED TO BE UNIVERSITY", KARAD, MALKAPUR, DIST. SATARA, MAHARASHTRA , INDIA-415539INDIAN
8. Whether the work is published or unpublished : UNPUBLISHED
9. Year and country of first publication and name, address and nationality of the publisher : N.A.
10. Years and countries of subsequent publications, if any, and names, addresses and nationalities of the publishers : N.A.
11. Names, addresses and nationalities of the owners of various rights comprising the copyright in the work and the extent of rights held by each, together with particulars of assignments and licences, if any : KRISHNA INSTITUTE OF MEDICAL SCIENCES "DEEMED TO BE UNIVERSITY", KARAD , KRISHNA INSTITUTE OF MEDICAL SCIENCES "DEEMED TO BE UNIVERSITY", KARAD, MALKAPUR, KARAD, DIST. SATARA, MAHARASHTRA, INDIA-415539INDIAN
12. Names, addresses and nationalities of other persons, if any, authorised to assign or licence of rights comprising the copyright : N.A.
13. If the work is an 'Artistic work', the location of the original work, including name, address and nationality of the person in possession of the work. (In the case of an architectural work, the year of completion of the work should also be shown). : N.A.
14. If the work is an 'Artistic work', whether it is registered under the Designs Act 2000 if yes give details. : N.A.
15. If the work is an 'Artistic work', capable of being registered as a design under the Designs Act 2000. whether it has been applied to an article though an industrial process and ,if yes ,the number of times it is reproduced. : N.A.
16. Remarks, if any :

Diary Number : 4919/2019-CO/L

Date of Registration : 01/04/2019

Date of Publication : 01/04/2019



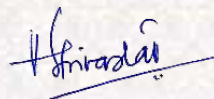

DEPUTY REGISTRAR OF COPYRIGHTS



Dated : 23/05/2019

1. Registration Number : **L-82718/2019**
 2. Name, address and nationality of the applicant : KRISHNA INSTITUTE OF MEDICAL SCIENCES "DEEMED TO BE UNIVERSITY", KARAD , KRISHNA INSTITUTE OF MEDICAL SCIENCES "DEEMED TO BE UNIVERSITY", KARAD, MALKAPUR, KARAD, DIST. SATARA, MAHARASHTRA, INDIA-415539INDIAN
 3. Nature of the applicant's interest in the copyright of the work : OWNER
 4. Class and description of the work : LITERARY/ DRAMATIC WORK
 5. Title of the work : PROBLEM BASED LEARNING (PBL) TUTORIAL-CONDUCT-RECORD-PRESENTATION AND ASSESSMENT PROFORMA FOR MEDICAL GRADUATE AND POSTGRADUATE STUDENTS
 6. Language of the work : ENGLISH
 7. Name, address and nationality of the author and if the author is deceased, date of his decease : DR. VIRENDRA CHANDRASHEKHAR PATIL , KRISHNA INSTITUTE OF MEDICAL SCIENCES "DEEMED TO BE UNIVERSITY", KARAD, MALKAPUR, KARAD, DIST. SATARA, MAHARASHTRA, INDIA-415539INDIAN
 8. Whether the work is published or unpublished : UNPUBLISHED
 9. Year and country of first publication and name, address and nationality of the publisher : N.A.
 10. Years and countries of subsequent publications, if any, and names, addresses and nationalities of the publishers : N.A.
 11. Names, addresses and nationalities of the owners of various rights comprising the copyright in the work and the extent of rights held by each, together with particulars of assignments and licences, if any : KRISHNA INSTITUTE OF MEDICAL SCIENCES "DEEMED TO BE UNIVERSITY", KARAD , KRISHNA INSTITUTE OF MEDICAL SCIENCES "DEEMED TO BE UNIVERSITY", KARAD, MALKAPUR, KARAD, DIST. SATARA, MAHARASHTRA, INDIA-415539INDIAN
 12. Names, addresses and nationalities of other persons, if any, authorised to assign or licence of rights comprising the copyright : N.A.
 13. If the work is an 'Artistic work', the location of the original work, including name, address and nationality of the person in possession of the work. (In the case of an architectural work, the year of completion of the work should also be shown). : N.A.
 14. If the work is an 'Artistic work', whether it is registered under the Designs Act 2000 if yes give details. : N.A.
 15. If the work is an 'Artistic work', capable of being registered as a design under the Designs Act 2000, whether it has been applied to an article through an industrial process and ,if yes ,the number of times it is reproduced. : N.A.
 16. Remarks, if any :
- Diary Number : 5535/2019-CO/L
Date of Application : 11/04/2019
Date of Receipt : 11/04/2019



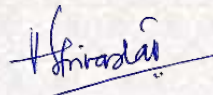

DEPUTY REGISTRAR OF COPYRIGHTS



Dated : 23/05/2019

1. Registration Number : **L-82694/2019**
 2. Name, address and nationality of the applicant : KRISHNA INSTITUTE OF MEDICAL SCIENCES "DEEMED TO BE UNIVERSITY", KARAD , NH4, PUNE - BANGALORE HIGHWAY, DIST.SATARA, AGASHIVNAGAR, MALKAPUR, MAHARASHTRA 415539-415539INDIAN
 3. Nature of the applicant's interest in the copyright of the work : OWNER
 4. Class and description of the work : LITERARY/ DRAMATIC WORK
 5. Title of the work : FOUR TIER SYSTEM OF LIFESTYLE MODIFICATION
 6. Language of the work : ENGLISH
 7. Name, address and nationality of the author and if the author is deceased, date of his decease : DR . T.POOVISHNU DEVI , KRISHNA INSTITUTE OF MEDICAL SCIENCES "DEEMED TO BE UNIVERSITY", KARAD-415539INDIAN
 8. Whether the work is published or unpublished : UNPUBLISHED
 9. Year and country of first publication and name, address and nationality of the publisher : N.A.
 10. Years and countries of subsequent publications, if any, and names, addresses and nationalities of the publishers : N.A.
 11. Names, addresses and nationalities of the owners of various rights comprising the copyright in the work and the extent of rights held by each, together with particulars of assignments and licences, if any : KRISHNA INSTITUTE OF MEDICAL SCIENCES "DEEMED TO BE UNIVERSITY", KARAD , NH4, PUNE - BANGALORE HIGHWAY, DIST.SATARA, AGASHIVNAGAR, MALKAPUR, MAHARASHTRA 415539-415539INDIAN
 12. Names, addresses and nationalities of other persons, if any, authorised to assign or licence of rights comprising the copyright : KRISHNA INSTITUTE OF MEDICAL SCIENCES "DEEMED TO BE UNIVERSITY", KARAD , NH4, PUNE - BANGALORE HIGHWAY, DIST.SATARA, AGASHIVNAGAR, MALKAPUR, MAHARASHTRA 415539-415539INDIAN
 13. If the work is an 'Artistic work', the location of the original work, including name, address and nationality of the person in possession of the work. (In the case of an architectural work, the year of completion of the work should also be shown). : N.A.
 14. If the work is an 'Artistic work', whether it is registered under the Designs Act 2000 if yes give details. : N.A.
 15. If the work is an 'Artistic work', capable of being registered as a design under the Designs Act 2000.whether it has been applied to an article though an industrial process and ,if yes ,the number of times it is reproduced. : N.A.
 16. Remarks, if any :
- Diary Number : 2661/2019-CO/L
Date of Application : 18/02/2019
Date of Receipt : 18/02/2019



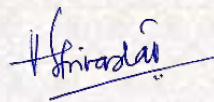

DEPUTY REGISTRAR OF COPYRIGHTS



Dated : 10/07/2019

1. Registration Number : **L-83964/2019**
2. Name, address and nationality of the applicant : KRISHNA INSTITUTE OF MEDICAL SCIENCES "DEEMED TO BE UNIVERSITY", KARAD , KRISHNA INSTITUTE OF MEDICAL SCIENCES "DEEMED TO BE UNIVERSITY", KARAD, MALKAPUR, KARAD, DIST. SATARA, MAHARASHTRA, INDIA-415539 INDIAN
3. Nature of the applicant's interest in the copyright of the work : OWNER
4. Class and description of the work : LITERARY/ DRAMATIC WORK
5. Title of the work : FAMILY PLANNING AND ITS IMPORTANCE'S
6. Language of the work : ENGLISH
7. Name, address and nationality of the author and if the author is deceased, date of his decease : MR. MAHENDRA M. ALATE , DIRECTORATE OF RESEARCH OFFICE, KRISHNA INSTITUTE OF MEDICAL SCIENCES "DEEMED TO BE UNIVERSITY", KARAD, MALKAPUR, KARAD, DIST. SATARA, MAHARASHTRA, INDIA-415539 INDIAN
MR. DHIRAJKUMAR A. MANE , DIRECTORATE OF RESEARCH OFFICE, KRISHNA INSTITUTE OF MEDICAL SCIENCES "DEEMED TO BE UNIVERSITY", KARAD, MALKAPUR, KARAD, DIST. SATARA, MAHARASHTRA, INDIA-415539 INDIAN
8. Whether the work is published or unpublished : UNPUBLISHED
9. Year and country of first publication and name, address and nationality of the publisher : N.A.
10. Years and countries of subsequent publications, if any, and names, addresses and nationalities of the publishers : N.A.
11. Names, addresses and nationalities of the owners of various rights comprising the copyright in the work and the extent of rights held by each, together with particulars of assignments and licences, if any : KRISHNA INSTITUTE OF MEDICAL SCIENCES "DEEMED TO BE UNIVERSITY", KARAD , KRISHNA INSTITUTE OF MEDICAL SCIENCES "DEEMED TO BE UNIVERSITY", KARAD, MALKAPUR, KARAD, DIST. SATARA, MAHARASHTRA, INDIA-415539 INDIAN
12. Names, addresses and nationalities of other persons, if any, authorised to assign or licence of rights comprising the copyright : N.A.
13. If the work is an 'Artistic work', the location of the original work, including name, address and nationality of the person in possession of the work. (In the case of an architectural work, the year of completion of the work should also be shown). : N.A.
14. If the work is an 'Artistic work' which is used or capable of being used in relation to any goods or services, the application should include a certification from the Registrar of Trade Marks in terms of the provision to Sub-Section (i) of Section 45 of the Copyright Act, 1957. : N.A.
15. If the work is an 'Artistic work', whether it is registered under the Designs Act 2000 if yes give details. : N.A.
16. If the work is an 'Artistic work', capable of being registered as a design under the Designs Act 2000. whether it has been applied to an article though an industrial process and ,if yes ,the number of times it is reproduced. : N.A.
17. F :



8469/2019-CO/L
04/06/2019
04/06/2019



DEPUTY REGISTRAR OF COPYRIGHTS



Dated : 24/05/2019

1. Registration Number : **L-82781/2019**
2. Name, address and nationality of the applicant : KRISHNA INSTITUTE OF MEDICAL SCIENCES "DEEMED TO BE UNIVERSITY", KARAD , KRISHNA INSTITUTE OF MEDICAL SCIENCES "DEEMED TO BE UNIVERSITY", KARAD, MALKAPUR, KARAD, DIST. SATARA, MAHARASHTRA, INDIA-415539
INDIAN
3. Nature of the applicant's interest in the copyright of the work : OWNER
4. Class and description of the work : LITERARY/ DRAMATIC WORK
5. Title of the work : QUESTIONNAIRE ON ATTITUDE OF PHYSIOTHERAPY STUDENTS ON PHYSIOTHERAPY EDUCATION
6. Language of the work : ENGLISH
7. Name, address and nationality of the author and if the author is deceased, date of his decease : DR. MS. T. POOVISHNU DEVI , DEPARTMENT OF ONCOLOGY PHYSIOTHERAPY, KRISHNA COLLEGE OF PHYSIOTHERAPY, KRISHNA INSTITUTE OF MEDICAL SCIENCES "DEEMED TO BE UNIVERSITY", KARAD, MALKAPUR, DIST. SATARA, MAHARASHTRA , INDIA-415539
INDIAN
8. Whether the work is published or unpublished : UNPUBLISHED
9. Year and country of first publication and name, address and nationality of the publisher : N.A.
10. Years and countries of subsequent publications, if any, and names, addresses and nationalities of the publishers : N.A.
11. Names, addresses and nationalities of the owners of various rights comprising the copyright in the work and the extent of rights held by each, together with particulars of assignments and licences, if any : KRISHNA INSTITUTE OF MEDICAL SCIENCES "DEEMED TO BE UNIVERSITY", KARAD , KRISHNA INSTITUTE OF MEDICAL SCIENCES "DEEMED TO BE UNIVERSITY", KARAD, MALKAPUR, KARAD, DIST. SATARA, MAHARASHTRA, INDIA-415539
INDIAN
12. Names, addresses and nationalities of other persons, if any, authorised to assign or licence of rights comprising the copyright : N.A.
13. If the work is an 'Artistic work', the location of the original work, including name, address and nationality of the person in possession of the work. (In the case of an architectural work, the year of completion of the work should also be shown). : N.A.
14. If the work is an 'Artistic work' which is used or capable of being used in relation to any goods or services, the application should include a certification from the Registrar of Trade Marks in terms of the provision to Sub-Section (i) of Section 45 of the Copyright Act, 1957. : N.A.
15. If the work is an 'Artistic work', whether it is registered under the Designs Act 2000 if yes give details. : N.A.
16. If the work is an 'Artistic work', capable of being registered as a design under the Designs Act 2000, whether it has been applied to an article though an industrial process and ,if yes ,the number of times it is reproduced. : N.A.
17. Remarks :



5518/2019-CO/L

11/04/2019

11/04/2019

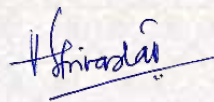

DEPUTY REGISTRAR OF COPYRIGHTS



Dated : 27/05/2019

1. Registration Number : **L-82785/2019**
2. Name, address and nationality of the applicant : KRISHNA INSTITUTE OF MEDICAL SCIENCES "DEEMED TO BE UNIVERSITY", KARAD , KRISHNA INSTITUTE OF MEDICAL SCIENCES "DEEMED TO BE UNIVERSITY", KARAD, MALKAPUR, KARAD, DIST. SATARA, MAHARASHTRA, INDIA-415539 INDIAN
3. Nature of the applicant's interest in the copyright of the work : OWNER
4. Class and description of the work : LITERARY/ DRAMATIC WORK
5. Title of the work : HACC- MODEL: HEATH APPROACH MODEL FOR CANCER CARE
6. Language of the work : ENGLISH
7. Name, address and nationality of the author and if the author is deceased, date of his decease : DR. RAJSINH MOHITE , DEPARTMENT OF COMMUNITY MEDICINE, KRISHNA INSTITUTE OF MEDICAL SCIENCES "DEEMED TO BE UNIVERSITY", KARAD, MALKAPUR, DIST. SATARA, MAHARASHTRA, INDIA-415539 INDIAN
8. Whether the work is published or unpublished : UNPUBLISHED
9. Year and country of first publication and name, address and nationality of the publisher : N.A.
10. Years and countries of subsequent publications, if any, and names, addresses and nationalities of the publishers : N.A.
11. Names, addresses and nationalities of the owners of various rights comprising the copyright in the work and the extent of rights held by each, together with particulars of assignments and licences, if any : KRISHNA INSTITUTE OF MEDICAL SCIENCES "DEEMED TO BE UNIVERSITY", KARAD , KRISHNA INSTITUTE OF MEDICAL SCIENCES "DEEMED TO BE UNIVERSITY", KARAD, MALKAPUR, KARAD, DIST. SATARA, MAHARASHTRA, INDIA-415539 INDIAN
12. Names, addresses and nationalities of other persons, if any, authorised to assign or licence of rights comprising the copyright : N.A.
13. If the work is an 'Artistic work', the location of the original work, including name, address and nationality of the person in possession of the work. (In the case of an architectural work, the year of completion of the work should also be shown). : N.A.
14. If the work is an 'Artistic work' which is used or capable of being used in relation to any goods or services, the application should include a certification from the Registrar of Trade Marks in terms of the provision to Sub-Section (i) of Section 45 of the Copyright Act, 1957. : N.A.
15. If the work is an 'Artistic work', whether it is registered under the Designs Act 2000 if yes give details. : N.A.
16. If the work is an 'Artistic work', capable of being registered as a design under the Designs Act 2000.whether it has been applied to an article though an industrial process and ,if yes ,the number of times it is reproduced. : N.A.
17. Remarks, if any :

Diary No. 5516/2019-CO/L
Date 11/04/2019
Date 11/04/2019



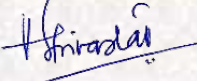

DEPUTY REGISTRAR OF COPYRIGHTS

Dated : 10/06/2019

1. Registration Number : **L-83140/2019**
2. Name, address and nationality of the applicant : KRISHNA INSTITUTE OF MEDICAL SCIENCES "DEEMED TO BE UNIVERSITY", KARAD , KRISHNA INSTITUTE OF MEDICAL SCIENCES "DEEMED TO BE UNIVERSITY", MALKAPUR, TAL. KARAD. DIST. - SATARA, MAHARASHTRA-415539 INDIAN
3. Nature of the applicant's interest in the copyright of the work : OWNER
4. Class and description of the work : LITERARY/ DRAMATIC WORK
5. Title of the work : REPORT ON ACTIVITY OF FMT PHOTOGNOSIS-2018
6. Language of the work : ENGLISH
7. Name, address and nationality of the author and if the author is deceased, date of his decease : DR. AJAY. V. PATIL , PROFESSOR AND HEAD, DEPARTMENT OF FORENSIC MEDICINE AND TOXICOLOGY, KRISHNA INSTITUTE OF MEDICAL SCIENCES "DEEMED TO BE UNIVERSITY", MALKAPUR, TAL. KARAD, DIST. SATARA, MAHARASHTRA, INDIA-415539 INDIAN
8. Whether the work is published or unpublished : UNPUBLISHED
9. Year and country of first publication and name, address and nationality of the publisher : N.A.
10. Years and countries of subsequent publications, if any, and names, addresses and nationalities of the publishers : N.A.
11. Names, addresses and nationalities of the owners of various rights comprising the copyright in the work and the extent of rights held by each, together with particulars of assignments and licences, if any : KRISHNA INSTITUTE OF MEDICAL SCIENCES "DEEMED TO BE UNIVERSITY", KARAD , KRISHNA INSTITUTE OF MEDICAL SCIENCES "DEEMED TO BE UNIVERSITY", MALKAPUR, TAL. KARAD. DIST. - SATARA, MAHARASHTRA-415539 INDIAN
12. Names, addresses and nationalities of other persons, if any, authorised to assign or licence of rights comprising the copyright : N.A.
13. If the work is an 'Artistic work', the location of the original work, including name, address and nationality of the person in possession of the work. (In the case of an architectural work, the year of completion of the work should also be shown). : N.A.
14. If the work is an 'Artistic work' which is used or capable of being used in relation to any goods or services, the application should include a certification from the Registrar of Trade Marks in terms of the provision to Sub-Section (i) of Section 45 of the Copyright Act, 1957 : N.A.
15. If the work is an 'Artistic work', whether it is registered under the Designs Act 2000 if yes give details. : N.A.
16. If the work is an 'Artistic work', capable of being registered as a design under the Designs Act 2000, whether it has been applied to an article though an industrial process and ,if yes ,the number of times it is reproduced. : N.A.
17. Remarks, if any :

Diary Number : 3038/2019-CO/L
Date of Application : 23/02/2019
Date of Receipt : 23/02/2019



Dated : 11/06/2019

1. Registration Number : **L-83171/2019**
2. Name, address and nationality of the applicant : KRISHNA INSTITUTE OF MEDICAL SCIENCES "DEEMED TO BE UNIVERSITY", KARAD , KRISHNA INSTITUTE OF MEDICAL SCIENCES "DEEMED TO BE UNIVERSITY", KARAD, MALKAPUR, KARAD, DIST. SATARA, MAHARASHTRA, INDIA-415539
INDIAN
3. Nature of the applicant's interest in the copyright of the work : OWNER
4. Class and description of the work : LITERARY/ DRAMATIC WORK
5. Title of the work : PRACTICAL MANUAL OF MENTAL HEALTH NURSING FOR UNDERGRADUATE AND POSTGRADUATE STUDENTS
6. Language of the work : ENGLISH
7. Name, address and nationality of the author and if the author is deceased, date of his decease : DR. VAISHALI R. MOHITE , DEAN & PRINCIPAL, KRISHNA INSTITUTE OF NURSING SCIENCES, KRISHNA INSTITUTE OF MEDICAL SCIENCES "DEEMED TO BE UNIVERSITY", KARAD, MALKAPUR, KARAD, DIST. SATARA, MAHARASHTRA, INDIA-415539
INDIAN
MR. PRABHUSWAMI HIREMATH , LECTURER, KRISHNA INSTITUTE OF NURSING SCIENCES, KRISHNA INSTITUTE OF MEDICAL SCIENCES "DEEMED TO BE UNIVERSITY", KARAD, MALKAPUR, KARAD, DIST. SATARA, MAHARASHTRA, INDIA-415539
INDIAN
8. Whether the work is published or unpublished : UNPUBLISHED
9. Year and country of first publication and name, address and nationality of the publisher : N.A.
10. Years and countries of subsequent publications, if any, and names, addresses and nationalities of the publishers : N.A.
11. Names, addresses and nationalities of the owners of various rights comprising the copyright in the work and the extent of rights held by each, together with particulars of assignments and licences, if any : KRISHNA INSTITUTE OF MEDICAL SCIENCES "DEEMED TO BE UNIVERSITY", KARAD , KRISHNA INSTITUTE OF MEDICAL SCIENCES "DEEMED TO BE UNIVERSITY", KARAD, MALKAPUR, KARAD, DIST. SATARA, MAHARASHTRA, INDIA-415539
INDIAN
12. Names, addresses and nationalities of other persons, if any, authorised to assign or licence of rights comprising the copyright : N.A.
13. If the work is an 'Artistic work', the location of the original work, including name, address and nationality of the person in possession of the work. (In the case of an architectural work, the year of completion of the work should also be shown). : N.A.
14. If the work is an 'Artistic work' which is used or capable of being used in relation to any goods or services, the application should include a certification from the Registrar of Trade Marks in terms of the provision to Sub-Section (i) of Section 45 of the Copyright Act, 1957. : N.A.
15. If the work is an 'Artistic work', whether it is registered under the Designs Act 2000 if yes give details. : N.A.
16. If the work is an 'Artistic work', capable of being registered as a design under the Designs Act 2000, whether it has been applied to an article, or to an industrial process and ,if yes ,the number of times it has been so applied : N.A.
17. :



4765/2019-CO/L

29/03/2019

Date

29/03/2019

DEPUTY REGISTRAR OF COPYRIGHTS



Dated : 14/06/2019

1. Registration Number : **L-83324/2019**
2. Name, address and nationality of the applicant : KRISHNA INSTITUTE OF MEDICAL SCIENCES "DEEMED TO BE UNIVERSITY", KARAD , KRISHNA INSTITUTE OF MEDICAL SCIENCES "DEEMED TO BE UNIVERSITY", KARAD, MALKAPUR, KARAD, DIST. SATARA, MAHARASHTRA, INDIA-415539 INDIAN
3. Nature of the applicant's interest in the copyright of the work : OWNER
4. Class and description of the work : LITERARY/ DRAMATIC WORK
5. Title of the work : STRUCTURED ASSESSMENT PRACTICAL EXAMINATION PROFORMA FOR POSTGRADUATE STUDENTS
6. Language of the work : ENGLISH
7. Name, address and nationality of the author and if the author is deceased, date of his decease : DR. VIRENDRA CHANDRASHEKHAR PATIL , KRISHNA INSTITUTE OF MEDICAL SCIENCES "DEEMED TO BE UNIVERSITY", KARAD, MALKAPUR, DIST. SATARA, MAHARASHTRA, INDIA-415539 INDIAN
8. Whether the work is published or unpublished : UNPUBLISHED
9. Year and country of first publication and name, address and nationality of the publisher : N.A.
10. Years and countries of subsequent publications, if any, and names, addresses and nationalities of the publishers : N.A.
11. Names, addresses and nationalities of the owners of various rights comprising the copyright in the work and the extent of rights held by each, together with particulars of assignments and licences, if any : KRISHNA INSTITUTE OF MEDICAL SCIENCES "DEEMED TO BE UNIVERSITY", KARAD , KRISHNA INSTITUTE OF MEDICAL SCIENCES "DEEMED TO BE UNIVERSITY", KARAD, MALKAPUR, KARAD, DIST. SATARA, MAHARASHTRA, INDIA-415539 INDIAN
12. Names, addresses and nationalities of other persons, if any, authorised to assign or licence of rights comprising the copyright : N.A.
13. If the work is an 'Artistic work', the location of the original work, including name, address and nationality of the person in possession of the work. (In the case of an architectural work, the year of completion of the work should also be shown). : N.A.
14. If the work is an 'Artistic work' which is used or capable of being used in relation to any goods or services, the application should include a certification from the Registrar of Trade Marks in terms of the provision to Sub-Section (i) of Section 45 of the Copyright Act, 1957. : N.A.
15. If the work is an 'Artistic work', whether it is registered under the Designs Act 2000 if yes give details. : N.A.
16. If the work is an 'Artistic work', capable of being registered as a design under the Designs Act 2000.whether it has been applied to an article though an industrial process and ,if yes ,the number of times it is reproduced. : N.A.
17. Remarks, if any :

Diary No. 5521/2019-CO/L
Date 11/04/2019
11/04/2019



DEPUTY REGISTRAR OF COPYRIGHTS



Dated : 08/07/2019

1. Registration Number : **L-83880/2019**
2. Name, address and nationality of the applicant : KRISHNA INSTITUTE OF MEDICAL SCIENCES "DEEMED TO BE UNIVERSITY", KARAD , NH4, PUNE - BANGALORE HIGHWAY, DIST.SATARA, AGASHIVNAGAR, MALKAPUR, MAHARASHTRA-415539
INDIAN
3. Nature of the applicant's interest in the copyright of the work : OWNER
4. Class and description of the work : LITERARY/ DRAMATIC WORK
5. Title of the work : PERFORMA FOR ASSISING THE KNOWLEDGE ABOUT DECREASING SEX RATIO AND ATTITUDE TOWARDS FEMALE FETICIDE OF PREGNANT WOMEN
6. Language of the work : ENGLISH
7. Name, address and nationality of the author and if the author is deceased, date of his decease : DR. MRS. JYOTI A. SALUNKHE , NH4, PUNE - BANGALORE HIGHWAY, DIST.SATARA, AGASHIVNAGAR, MALKAPUR, MAHARASHTRA-415539
INDIAN
DR. MR. AVINASH H. SALUNKHE , NH4, PUNE - BANGALORE HIGHWAY, DIST.SATARA, AGASHIVNAGAR, MALKAPUR, MAHARASHTRA-415539
INDIAN
DR. SATISH V. KAKADE , NH4, PUNE - BANGALORE HIGHWAY, DIST.SATARA, AGASHIVNAGAR, MALKAPUR, MAHARASHTRA-41553
INDIAN
8. Whether the work is published or unpublished : UNPUBLISHED
9. Year and country of first publication and name, address and nationality of the publisher : N.A.
10. Years and countries of subsequent publications, if any, and names, addresses and nationalities of the publishers : N.A.
11. Names, addresses and nationalities of the owners of various rights comprising the copyright in the work and the extent of rights held by each, together with particulars of assignments and licences, if any : KRISHNA INSTITUTE OF MEDICAL SCIENCES "DEEMED TO BE UNIVERSITY", KARAD , NH4, PUNE - BANGALORE HIGHWAY, DIST.SATARA, AGASHIVNAGAR, MALKAPUR, MAHARASHTRA-415539
INDIAN
12. Names, addresses and nationalities of other persons, if any, authorised to assign or licence of rights comprising the copyright : KRISHNA INSTITUTE OF MEDICAL SCIENCES "DEEMED TO BE UNIVERSITY", KARAD , NH4, PUNE - BANGALORE HIGHWAY, DIST.SATARA, AGASHIVNAGAR, MALKAPUR, MAHARASHTRA-415539
INDIAN
13. If the work is an 'Artistic work', the location of the original work, including name, address and nationality of the person in possession of the work. (In the case of an architectural work, the year of completion of the work should also be shown). : N.A.
14. If the work is an 'Artistic work' which is used or capable of being used in relation to any goods or services, the application should include a certification from the Registrar of Trade Marks in terms of the provision to Sub-Section (i) of Section 45 of the Copyright Act, 1957. : N.A.
15. If the work is an 'Artistic work', whether it is registered under the Designs Act 2000 if yes give details. : N.A.
16. If the work is an 'Artistic work', capable of being registered as a design under the Designs Act 2000, whether it has been applied to an industrial process and ,if yes ,the number of times : N.A.
17. :



7911/2019-CO/L

Date of Receipt : 24/05/2019

Date of Receipt : 24/05/2019

DEPUTY REGISTRAR OF COPYRIGHTS



Dated : 09/07/2019

1. Registration Number : **L-83916/2019**
2. Name, address and nationality of the applicant : KRISHNA INSTITUTE OF MEDICAL SCIENCES "DEEMED TO BE UNIVERSITY", KARAD , NH4, PUNE - BANGALORE HIGHWAY, DIST.SATARA, AGASHIVNAGAR, MALKAPUR, MAHARASHTRA-415539
INDIAN
3. Nature of the applicant's interest in the copyright of the work : OWNER
4. Class and description of the work : LITERARY/ DRAMATIC WORK
5. Title of the work : RESISTANCE TRAINING SPIROMETER
6. Language of the work : ENGLISH
7. Name, address and nationality of the author and if the author is deceased, date of his decease : DR. MS. T. POOVISHNU DEVI , NH4, PUNE - BANGALORE HIGHWAY, DIST.SATARA, AGASHIVNAGAR, MALKAPUR, MAHARASHTRA 415539-415539
INDIAN
8. Whether the work is published or unpublished : UNPUBLISHED
9. Year and country of first publication and name, address and nationality of the publisher : N.A.
10. Years and countries of subsequent publications, if any, and names, addresses and nationalities of the publishers : N.A.
11. Names, addresses and nationalities of the owners of various rights comprising the copyright in the work and the extent of rights held by each, together with particulars of assignments and licences, if any : KRISHNA INSTITUTE OF MEDICAL SCIENCES "DEEMED TO BE UNIVERSITY", KARAD , NH4, PUNE - BANGALORE HIGHWAY, DIST.SATARA, AGASHIVNAGAR, MALKAPUR, MAHARASHTRA-415539
INDIAN
12. Names, addresses and nationalities of other persons, if any, authorised to assign or licence of rights comprising the copyright : KRISHNA INSTITUTE OF MEDICAL SCIENCES "DEEMED TO BE UNIVERSITY", KARAD , NH4, PUNE - BANGALORE HIGHWAY, DIST.SATARA, AGASHIVNAGAR, MALKAPUR, MAHARASHTRA-415539
INDIAN
13. If the work is an 'Artistic work', the location of the original work, including name, address and nationality of the person in possession of the work. (In the case of an architectural work, the year of completion of the work should also be shown). : N.A.
14. If the work is an 'Artistic work' which is used or capable of being used in relation to any goods or services, the application should include a certification from the Registrar of Trade Marks in terms of the provision to Sub-Section (i) of Section 45 of the Copyright Act, 1957. : N.A.
15. If the work is an 'Artistic work', whether it is registered under the Designs Act 2000 if yes give details. : N.A.
16. If the work is an 'Artistic work', capable of being registered as a design under the Designs Act 2000.whether it has been applied to an article though an industrial process and ,if yes ,the number of times it is reproduced. : N.A.
17. Remarks, if any :

Diary Number : 7916/2019-CO/L

Date of Application : 25/05/2019

Date of Registration : 25/05/2019



DEPUTY REGISTRAR OF COPYRIGHTS



Dated : 08/07/2019

1. Registration Number : **L-83877/2019**
2. Name, address and nationality of the applicant : KRISHNA INSTITUTE OF MEDICAL SCIENCES "DEEMED TO BE UNIVERSITY", KARAD , NH4, PUNE - BANGALORE HIGHWAY, DIST.SATARA, AGASHIVNAGAR, MALKAPUR, MAHARASHTRA-415539
INDIAN
3. Nature of the applicant's interest in the copyright of the work : OWNER
4. Class and description of the work : LITERARY/ DRAMATIC WORK
5. Title of the work : ROLE OF CONTRACEPTIVE METHOD WITH REFERENCE TO CONTROL POPULATION GROWTH IN INDIA AS A HOLISTIC MEASURE
6. Language of the work : ENGLISH
7. Name, address and nationality of the author and if the author is deceased, date of his decease : MR. MAHENDRA ALATE , NH4, PUNE - BANGALORE HIGHWAY, DIST.SATARA, AGASHIVNAGAR, MALKAPUR, MAHARASHTRA-415539
INDIAN
MR. DHIRAJKUMAR MANE , NH4, PUNE - BANGALORE HIGHWAY, DIST.SATARA, AGASHIVNAGAR, MALKAPUR, MAHARASHTRA 415539-415539
INDIAN
MR. ROHAN S. PHATAK , NH4, PUNE - BANGALORE HIGHWAY, DIST.SATARA, AGASHIVNAGAR, MALKAPUR, MAHARASHTRA 415539-415539
INDIAN
8. Whether the work is published or unpublished : UNPUBLISHED
9. Year and country of first publication and name, address and nationality of the publisher : N.A.
10. Years and countries of subsequent publications, if any, and names, addresses and nationalities of the publishers : N.A.
11. Names, addresses and nationalities of the owners of various rights comprising the copyright in the work and the extent of rights held by each, together with particulars of assignments and licences, if any : KRISHNA INSTITUTE OF MEDICAL SCIENCES "DEEMED TO BE UNIVERSITY", KARAD , NH4, PUNE - BANGALORE HIGHWAY, DIST.SATARA, AGASHIVNAGAR, MALKAPUR, MAHARASHTRA-415539
INDIAN
12. Names, addresses and nationalities of other persons, if any, authorised to assign or licence of rights comprising the copyright : KRISHNA INSTITUTE OF MEDICAL SCIENCES "DEEMED TO BE UNIVERSITY", KARAD , NH4, PUNE - BANGALORE HIGHWAY, DIST.SATARA, AGASHIVNAGAR, MALKAPUR, MAHARASHTRA-415539
INDIAN
13. If the work is an 'Artistic work', the location of the original work, including name, address and nationality of the person in possession of the work. (In the case of an architectural work, the year of completion of the work should also be shown). : N.A.
14. If the work is an 'Artistic work' which is used or capable of being used in relation to any goods or services, the application should include a certification from the Registrar of Trade Marks in terms of the provision to Sub-Section (i) of Section 45 of the Copyright Act, 1957. : N.A.
15. If the work is an 'Artistic work', whether it is registered under the Designs Act 2000 if yes give details. : N.A.
16. If the work is an 'Artistic work', capable of being registered as a design under the Designs Act 2000, whether it has been applied to an industrial process and ,if yes ,the number of times : N.A.
17. :



7891/2019-CO/L

Date of Receipt : 24/05/2019

Date of Receipt : 24/05/2019

DEPUTY REGISTRAR OF COPYRIGHTS



Dated : 09/07/2019

1. Registration Number : **L-83927/2019**
2. Name, address and nationality of the applicant : KRISHNA INSTITUTE OF MEDICAL SCIENCES "DEEMED TO BE UNIVERSITY", KARAD , NH4, PUNE - BANGALORE HIGHWAY, DIST.SATARA, AGASHIVNAGAR, MALKAPUR, MAHARASHTRA-415539
INDIAN
3. Nature of the applicant's interest in the copyright of the work : OWNER
4. Class and description of the work : LITERARY/ DRAMATIC WORK
5. Title of the work : A STANDARDIZED SCHEDULE FOR FOUNDATION COURSE (MBBS-1) IN THE CONTEXT OF REVISED GUIDELINES OF MEDICAL COUNCIL OF INDIA (ACADEMIC YEAR 2019)
6. Language of the work : ENGLISH
7. Name, address and nationality of the author and if the author is deceased, date of his decease : DR. VIRENDRA CHANDRASHEKHAR PATIL , NH4, PUNE - BANGALORE HIGHWAY, DIST.SATARA, AGASHIVNAGAR, MALKAPUR, MAHARASHTRA-415539
INDIAN
8. Whether the work is published or unpublished : UNPUBLISHED
9. Year and country of first publication and name, address and nationality of the publisher : N.A.
10. Years and countries of subsequent publications, if any, and names, addresses and nationalities of the publishers : N.A.
11. Names, addresses and nationalities of the owners of various rights comprising the copyright in the work and the extent of rights held by each, together with particulars of assignments and licences, if any : KRISHNA INSTITUTE OF MEDICAL SCIENCES "DEEMED TO BE UNIVERSITY", KARAD , NH4, PUNE - BANGALORE HIGHWAY, DIST.SATARA, AGASHIVNAGAR, MALKAPUR, MAHARASHTRA-415539
INDIAN
12. Names, addresses and nationalities of other persons, if any, authorised to assign or licence of rights comprising the copyright : KRISHNA INSTITUTE OF MEDICAL SCIENCES "DEEMED TO BE UNIVERSITY", KARAD , NH4, PUNE - BANGALORE HIGHWAY, DIST.SATARA, AGASHIVNAGAR, MALKAPUR, MAHARASHTRA-415539
INDIAN
13. If the work is an 'Artistic work', the location of the original work, including name, address and nationality of the person in possession of the work. (In the case of an architectural work, the year of completion of the work should also be shown). : N.A.
14. If the work is an 'Artistic work' which is used or capable of being used in relation to any goods or services, the application should include a certification from the Registrar of Trade Marks in terms of the provision to Sub-Section (i) of Section 45 of the Copyright Act, 1957. : N.A.
15. If the work is an 'Artistic work', whether it is registered under the Designs Act 2000 if yes give details. : N.A.
16. If the work is an 'Artistic work', capable of being registered as a design under the Designs Act 2000.whether it has been applied to an article though an industrial process and ,if yes ,the number of times it is reproduced. : N.A.
17. Remarks, if any :

Diary No. 7931/2019-CO/L
Date 25/05/2019
25/05/2019



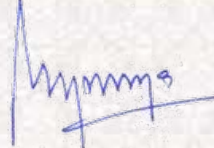

DEPUTY REGISTRAR OF COPYRIGHTS

Dated : 10/07/2019

1. Registration Number : **L-83959/2019**
2. Name, address and nationality of the applicant : KRISHNA INSTITUTE OF MEDICAL SCIENCES "DEEMED TO BE UNIVERSITY", KARAD , KRISHNA INSTITUTE OF MEDICAL SCIENCES "DEEMED TO BE UNIVERSITY", KARAD, MALKAPUR, KARAD, DIST. SATARA, MAHARASHTRA, INDIA-415539
INDIAN
3. Nature of the applicant's interest in the copyright of the work : OWNER
4. Class and description of the work : LITERARY/ DRAMATIC WORK
5. Title of the work : IMPLEMENTATION OF SIX SIGMA TECHNIQUE IN MANUFACTURING PROCESS: A CASE STUDY OF DISHA-AUTO COMPONENTS PVT. LTD.
6. Language of the work : ENGLISH
7. Name, address and nationality of the author and if the author is deceased, date of his decease : MR. DHIRAJKUMAR A. MANE , DIRECTORATE OF RESEARCH OFFICE, KRISHNA INSTITUTE OF MEDICAL SCIENCES "DEEMED TO BE UNIVERSITY", KARAD, MALKAPUR, KARAD, DIST. SATARA, MAHARASHTRA, INDIA-415539
INDIAN

MR. MAHENDRA M. ALATE , DIRECTORATE OF RESEARCH OFFICE, KRISHNA INSTITUTE OF MEDICAL SCIENCES "DEEMED TO BE UNIVERSITY", KARAD, MALKAPUR, KARAD, DIST. SATARA, MAHARASHTRA, INDIA-415539
INDIAN
8. Whether the work is published or unpublished : UNPUBLISHED
9. Year and country of first publication and name, address and nationality of the publisher : N.A.
10. Years and countries of subsequent publications, if any, and names, addresses and nationalities of the publishers : N.A.
11. Names, addresses and nationalities of the owners of various rights comprising the copyright in the work and the extent of rights held by each, together with particulars of assignments and licences, if any : KRISHNA INSTITUTE OF MEDICAL SCIENCES "DEEMED TO BE UNIVERSITY", KARAD , KRISHNA INSTITUTE OF MEDICAL SCIENCES "DEEMED TO BE UNIVERSITY", KARAD, MALKAPUR, KARAD, DIST. SATARA, MAHARASHTRA, INDIA-415539
INDIAN
12. Names, addresses and nationalities of other persons, if any, authorised to assign or licence of rights comprising the copyright : N.A.
13. If the work is an 'Artistic work', the location of the original work, including name, address and nationality of the person in possession of the work. (In the case of an architectural work, the year of completion of the work should also be shown). : N.A.
14. If the work is an 'Artistic work' which is used or capable of being used in relation to any goods or services, the application should include a certification from the Registrar of Trade Marks in terms of the provision to Sub-Section (i) of Section 45 of the Copyright Act, 1957 : N.A.
15. If the work is an 'Artistic work', whether it is registered under the Designs Act 2000 if yes give details. : N.A.
16. If the work is an 'Artistic work', capable of being registered as a design under the Designs Act 2000.whether it has been applied to an article though an industrial process and ,if yes ,the number of times it is reproduced. : N.A.
17. Remarks, if any :

Dated : 23/07/2019

1. Registration Number : **L-84235/2019**
2. Name, address and nationality of the applicant : KRISHNA INSTITUTE OF MEDICAL SCIENCES "DEEMED TO BE UNIVERSITY", KARAD , KRISHNA INSTITUTE OF MEDICAL SCIENCES "DEEMED TO BE UNIVERSITY", KARAD, MALKAPUR, KARAD, DIST. SATARA, MAHARASHTRA, INDIA-415539 INDIAN
3. Nature of the applicant's interest in the copyright of the work : OWNER
4. Class and description of the work : LITERARY/ DRAMATIC WORK
5. Title of the work : OPERATION THEATRE TECHNICIAN
6. Language of the work : MARATHI
7. Name, address and nationality of the author and if the author is deceased, date of his decease : DR. SUNITA H. TATA , DIRECTOR OF NURSING SCIENCES, KRISHNA HOSPITAL, KRISHNA INSTITUTE OF MEDICAL SCIENCES "DEEMED TO BE UNIVERSITY", KARAD, MALKAPUR, KARAD, DIST. SATARA, MAHARASHTRA, INDIA-415539 INDIAN
8. Whether the work is published or unpublished : UNPUBLISHED
9. Year and country of first publication and name, address and nationality of the publisher : N.A.
10. Years and countries of subsequent publications, if any, and names, addresses and nationalities of the publishers : N.A.
11. Names, addresses and nationalities of the owners of various rights comprising the copyright in the work and the extent of rights held by each, together with particulars of assignments and licences, if any : KRISHNA INSTITUTE OF MEDICAL SCIENCES "DEEMED TO BE UNIVERSITY", KARAD , KRISHNA INSTITUTE OF MEDICAL SCIENCES "DEEMED TO BE UNIVERSITY", KARAD, MALKAPUR, KARAD, DIST. SATARA, MAHARASHTRA, INDIA-415539 INDIAN
12. Names, addresses and nationalities of other persons, if any, authorised to assign or licence of rights comprising the copyright : N.A.
13. If the work is an 'Artistic work', the location of the original work, including name, address and nationality of the person in possession of the work. (In the case of an architectural work, the year of completion of the work should also be shown). : N.A.
14. If the work is an 'Artistic work' which is used or capable of being used in relation to any goods or services, the application should include a certification from the Registrar of Trade Marks in terms of the provision to Sub-Section (i) of Section 45 of the Copyright Act, 1957 : N.A.
15. If the work is an 'Artistic work', whether it is registered under the Designs Act 2000 if yes give details. : N.A.
16. If the work is an 'Artistic work', capable of being registered as a design under the Designs Act 2000, whether it has been applied to an article though an



Dated : 11/07/2019

1. Registration Number : **L-83994/2019**
2. Name, address and nationality of the applicant : KRISHNA INSTITUTE OF MEDICAL SCIENCES "DEEMED TO BE UNIVERSITY", KARAD , KRISHNA INSTITUTE OF MEDICAL SCIENCES "DEEMED TO BE UNIVERSITY", KARAD, MALKAPUR, KARAD, DIST. SATARA, MAHARASHTRA, INDIA-415539
INDIAN
3. Nature of the applicant's interest in the copyright of the work : OWNER
4. Class and description of the work : LITERARY/ DRAMATIC WORK
5. Title of the work : RUPEE VERSUS DOLLAR: AN OVERVIEW IN THE PRESENT GLOBAL CONTEXT (WITH SPECIAL EMPHASIS ON INDIAN MARKET)
6. Language of the work : ENGLISH
7. Name, address and nationality of the author and if the author is deceased, date of his decease : MR. DHIRAJKUMAR MANE , DIRECTORATE OF RESEARCH OFFICE, KRISHNA INSTITUTE OF MEDICAL SCIENCES "DEEMED TO BE UNIVERSITY", KARAD, MALKAPUR, KARAD, DIST. SATARA, MAHARASHTRA, INDIA-415539
INDIAN
MR. MAHENDRA ALATE , DIRECTORATE OF RESEARCH OFFICE, KRISHNA INSTITUTE OF MEDICAL SCIENCES "DEEMED TO BE UNIVERSITY", KARAD, MALKAPUR, KARAD, DIST. SATARA, MAHARASHTRA, INDIA-415539
INDIAN
8. Whether the work is published or unpublished : UNPUBLISHED
9. Year and country of first publication and name, address and nationality of the publisher : N.A.
10. Years and countries of subsequent publications, if any, and names, addresses and nationalities of the publishers : N.A.
11. Names, addresses and nationalities of the owners of various rights comprising the copyright in the work and the extent of rights held by each, together with particulars of assignments and licences, if any : KRISHNA INSTITUTE OF MEDICAL SCIENCES "DEEMED TO BE UNIVERSITY", KARAD , KRISHNA INSTITUTE OF MEDICAL SCIENCES "DEEMED TO BE UNIVERSITY", KARAD, MALKAPUR, KARAD, DIST. SATARA, MAHARASHTRA, INDIA-415539
INDIAN
12. Names, addresses and nationalities of other persons, if any, authorised to assign or licence of rights comprising the copyright : N.A.
13. If the work is an 'Artistic work', the location of the original work, including name, address and nationality of the person in possession of the work. (In the case of an architectural work, the year of completion of the work should also be shown). : N.A.
14. If the work is an 'Artistic work' which is used or capable of being used in relation to any goods or services, the application should include a certification from the Registrar of Trade Marks in terms of the provision to Sub-Section (i) of Section 45 of the Copyright Act, 1957. : N.A.
15. If the work is an 'Artistic work', whether it is registered under the Designs Act 2000 if yes give details. : N.A.
16. If the work is an 'Artistic work', capable of being registered as a design under the Designs Act 2000, whether it has been applied to an article or to an industrial process and ,if yes ,the number of times it is : N.A.
17. :



8507/2019-CO/L

04/06/2019

04/06/2019

DEPUTY REGISTRAR OF COPYRIGHTS



Dated : 15/07/2019

- | | | |
|--|---|--|
| 1. Registration Number | : | L-84078/2019 |
| 2. Name, address and nationality of the applicant | : | KRISHNA INSTITUTE OF MEDICAL SCIENCES "DEEMED TO BE UNIVERSITY", KARAD , KRISHNA INSTITUTE OF MEDICAL SCIENCES "DEEMED TO BE UNIVERSITY", KARAD, MALKAPUR, KARAD, DIST. SATARA, MAHARASHTRA, INDIA-415539
INDIAN |
| 3. Nature of the applicant's interest in the copyright of the work | : | OWNER |
| 4. Class and description of the work | : | LITERARY/ DRAMATIC WORK |
| 5. Title of the work | : | AN APPROACH TO REALIZE THE PRODUCTS FROM A MARKET |
| 6. Language of the work | : | ENGLISH |
| 7. Name, address and nationality of the author and if the author is deceased, date of his decease | : | MR. DHIRAJKUMAR MANE , DIRECTORATE OF RESEARCH, KRISHNA INSTITUTE OF MEDICAL SCIENCES "DEEMED TO BE UNIVERSITY", KARAD, MALKAPUR, KARAD, DIST. SATARA, MAHARASHTRA, INDIA-415539
INDIAN
MR. MAHENDRA ALATE , DIRECTORATE OF RESEARCH, KRISHNA INSTITUTE OF MEDICAL SCIENCES "DEEMED TO BE UNIVERSITY", KARAD, MALKAPUR, KARAD, DIST. SATARA, MAHARASHTRA, INDIA-415539
INDIAN |
| 8. Whether the work is published or unpublished | : | UNPUBLISHED |
| 9. Year and country of first publication and name, address and nationality of the publisher | : | N.A. |
| 10. Years and countries of subsequent publications, if any, and names, addresses and nationalities of the publishers | : | N.A. |
| 11. Names, addresses and nationalities of the owners of various rights comprising the copyright in the work and the extent of rights held by each, together with particulars of assignments and licences, if any | : | KRISHNA INSTITUTE OF MEDICAL SCIENCES "DEEMED TO BE UNIVERSITY", KARAD , KRISHNA INSTITUTE OF MEDICAL SCIENCES "DEEMED TO BE UNIVERSITY", KARAD, MALKAPUR, KARAD, DIST. SATARA, MAHARASHTRA, INDIA-415539
INDIAN |
| 12. Names, addresses and nationalities of other persons, if any, authorised to assign or licence of rights comprising the copyright | : | N.A. |
| 13. If the work is an 'Artistic work', the location of the original work, including name, address and nationality of the person in possession of the work. (In the case of an architectural work, the year of completion of the work should also be shown). | : | N.A. |
| 14. If the work is an 'Artistic work' which is used or capable of being used in relation to any goods or services, the application should include a certification from the Registrar of Trade Marks in terms of the provision to Sub-Section (i) of Section 45 of the Copyright Act, 1957. | : | N.A. |
| 15. If the work is an 'Artistic work', whether it is registered under the Designs Act 2000 if yes give details. | : | N.A. |
| 16. If the work is an 'Artistic work', capable of being registered as a design under the Designs Act 2000, whether it has been applied to an article though an industrial process and ,if yes ,the number of times it is reproduced | : | N.A. |
| 17. F | : | |



8514/2019-CO/L

04/06/2019

04/06/2019

DEPUTY REGISTRAR OF COPYRIGHTS



Dated : 16/07/2019

- | | | |
|--|---|---|
| 1. Registration Number | : | L-84087/2019 |
| 2. Name, address and nationality of the applicant | : | KRISHNA INSTITUTE OF MEDICAL SCIENCES "DEEMED TO BE UNIVERSITY", KARAD , KRISHNA INSTITUTE OF MEDICAL SCIENCES "DEEMED TO BE UNIVERSITY", KARAD, MALKAPUR, KARAD, DIST. SATARA, MAHARASHTRA, INDIA-415539
INDIAN |
| 3. Nature of the applicant's interest in the copyright of the work | : | OWNER |
| 4. Class and description of the work | : | LITERARY/ DRAMATIC WORK AN ARTICLE ON OBJECTIVE STRUCTURED CLINICAL EXAMINATION AS AN ASSESSMENT TOOL TO DETERMINE CLINICAL PERFORMANCE AND COMPETENCY BASED MEDICAL EDUCATION. |
| 5. Title of the work | : | OBJECTIVE STRUCTURED CLINICAL EXAMINATION (OSCE) STATIONS AND PROFORMA FOR MEDICAL GRADUATE AND POSTGRADUATE STUDENTS |
| 6. Language of the work | : | ENGLISH |
| 7. Name, address and nationality of the author and if the author is deceased, date of his decease | : | DR. VIRENDRA C. PATIL , KRISHNA INSTITUTE OF MEDICAL SCIENCES "DEEMED TO BE UNIVERSITY", KARAD, MALKAPUR, KARAD, DIST. SATARA, MAHARASHTRA, INDIA-415539
INDIAN |
| 8. Whether the work is published or unpublished | : | UNPUBLISHED |
| 9. Year and country of first publication and name, address and nationality of the publisher | : | N.A. |
| 10. Years and countries of subsequent publications, if any, and names, addresses and nationalities of the publishers | : | N.A. |
| 11. Names, addresses and nationalities of the owners of various rights comprising the copyright in the work and the extent of rights held by each, together with particulars of assignments and licences, if any | : | KRISHNA INSTITUTE OF MEDICAL SCIENCES "DEEMED TO BE UNIVERSITY", KARAD , KRISHNA INSTITUTE OF MEDICAL SCIENCES "DEEMED TO BE UNIVERSITY", KARAD, MALKAPUR, KARAD, DIST. SATARA, MAHARASHTRA, INDIA-415539
INDIAN |
| 12. Names, addresses and nationalities of other persons, if any, authorised to assign or licence of rights comprising the copyright | : | N.A. |
| 13. If the work is an 'Artistic work', the location of the original work, including name, address and nationality of the person in possession of the work. (In the case of an architectural work, the year of completion of the work should also be shown). | : | N.A. |
| 14. If the work is an 'Artistic work' which is used or capable of being used in relation to any goods or services, the application should include a certification from the Registrar of Trade Marks in terms of the provision to Sub-Section (i) of Section 45 of the Copyright Act, 1957. | : | N.A. |
| 15. If the work is an 'Artistic work', whether it is registered under the Designs Act 2000 if yes give details. | : | N.A. |
| 16. If the work is an 'Artistic work', capable of being registered as a design under the Designs Act 2000. whether it has been applied to an article though an industrial process and ,if yes ,the number of times it is registered. | : | N.A. |
| 17. F | : | |



8548/2019-CO/L

05/06/2019

05/06/2019

DEPUTY REGISTRAR OF COPYRIGHTS

Dated : 26/07/2019

1. Registration Number : **L-84333/2019**
2. Name, address and nationality of the applicant : KRISHNA INSTITUTE OF MEDICAL SCIENCES "DEEMED TO BE UNIVERSITY", KARAD , NH4, PUNE - BANGALORE HIGHWAY, DIST.SATARA, AGASHIVNAGAR, MALKAPUR, MAHARASHTRA-415539 INDIAN
3. Nature of the applicant's interest in the copyright of the work : OWNER
4. Class and description of the work : LITERARY/ DRAMATIC WORK
5. Title of the work : FRAGMENTATION PATTERN AND CALCULATION OF SOLUBILITY PARAMETERS OF ACECLOFENAC BY DIFFERENT METHODS
6. Language of the work : ENGLISH
7. Name, address and nationality of the author and if the author is deceased, date of his decease : MS. MANDRUPKAR S.N , NH4, PUNE - BANGALORE HIGHWAY, DIST.SATARA, AGASHIVNAGAR, MALKAPUR, MAHARASHTRA-415539 INDIAN

DR. RAJENDRA C.DOIJAD , NH4, PUNE - BANGALORE HIGHWAY, DIST.SATARA, AGASHIVNAGAR, MALKAPUR, MAHARASHTRA-415539 INDIAN

DR. AMOL S. SHETE , NH4, PUNE - BANGALORE HIGHWAY, DIST.SATARA, AGASHIVNAGAR, MALKAPUR, MAHARASHTRA-415539 INDIAN
8. Whether the work is published or unpublished : UNPUBLISHED
9. Year and country of first publication and name, address and nationality of the publisher : N.A.
10. Years and countries of subsequent publications, if any, and names, addresses and nationalities of the publishers : N.A.
11. Names, addresses and nationalities of the owners of various rights comprising the copyright in the work and the extent of rights held by each, together with particulars of assignments and licences, if any : KRISHNA INSTITUTE OF MEDICAL SCIENCES "DEEMED TO BE UNIVERSITY", KARAD , NH4, PUNE - BANGALORE HIGHWAY, DIST.SATARA, AGASHIVNAGAR, MALKAPUR, MAHARASHTRA-415539 INDIAN
12. Names, addresses and nationalities of other persons, if any, authorised to assign or licence of rights comprising the copyright : KRISHNA INSTITUTE OF MEDICAL SCIENCES "DEEMED TO BE UNIVERSITY", KARAD , NH4, PUNE - BANGALORE HIGHWAY, DIST.SATARA, AGASHIVNAGAR, MALKAPUR, MAHARASHTRA-415539 INDIAN
13. If the work is an 'Artistic work', the location of the original work, including name, address and nationality of the person in possession of the work. (In the case of an architectural work, the year of completion of the work should also be shown). : N.A.
14. If the work is an 'Artistic work' which is used or capable of being used in relation to any goods or services, the application should include a certification from the Registrar of Trade Marks in terms of the provision to Sub-Section (i) of Section 45 of the Copyright Act, 1957 : N.A.
15. If the work is an 'Artistic work', whether it is registered under the Designs Act 2000 if yes give details. : N.A.
16. If the work is an 'Artistic work', capable of being registered as a design under the Designs Act 2000.whether it has been applied to an article though an industrial process and ,if yes ,the number of times it is reproduced. : N.A.
17. Remarks, if any :

Diary Number : 2659/2019-CO/L
Date of Application : 18/02/2019
Date of Receipt : 18/02/2019

DEPUTY REGISTRAR OF COPYRIGHTS



Dated : 28/08/2019

1. Registration Number : **L-85050/2019**
2. Name, address and nationality of the applicant : KRISHNA INSTITUTE OF MEDICAL SCIENCES "DEEMED TO BE UNIVERSITY", KARAD , KRISHNA INSTITUTE OF MEDICAL SCIENCES "DEEMED TO BE UNIVERSITY", KARAD, MALKAPUR, KARAD, DIST. SATARA, MAHARASHTRA, INDIA-415539 INDIAN
3. Nature of the applicant's interest in the copyright of the work : OWNER
4. Class and description of the work : LITERARY/ DRAMATIC WORK
5. Title of the work : A STATISTICAL APPROACH ON PORTFOLIO MANAGEMENT
6. Language of the work : ENGLISH
7. Name, address and nationality of the author and if the author is deceased, date of his decease : MR. DHIRAJKUMAR MANE , STATISTICIAN, DIRECTORATE OF RESEARCH, KRISHNA INSTITUTE OF MEDICAL SCIENCES "DEEMED TO BE UNIVERSITY", KARAD, MALKAPUR, DIST. SATARA, MAHARASHTRA , INDIA-415539 INDIAN
8. Whether the work is published or unpublished : UNPUBLISHED
9. Year and country of first publication and name, address and nationality of the publisher : N.A.
10. Years and countries of subsequent publications, if any, and names, addresses and nationalities of the publishers : N.A.
11. Names, addresses and nationalities of the owners of various rights comprising the copyright in the work and the extent of rights held by each, together with particulars of assignments and licences, if any : KRISHNA INSTITUTE OF MEDICAL SCIENCES "DEEMED TO BE UNIVERSITY", KARAD , KRISHNA INSTITUTE OF MEDICAL SCIENCES "DEEMED TO BE UNIVERSITY", KARAD, MALKAPUR, KARAD, DIST. SATARA, MAHARASHTRA, INDIA-415539 INDIAN
12. Names, addresses and nationalities of other persons, if any, authorised to assign or licence of rights comprising the copyright : N.A.
13. If the work is an 'Artistic work', the location of the original work, including name, address and nationality of the person in possession of the work. (In the case of an architectural work, the year of completion of the work should also be shown). : N.A.
14. If the work is an 'Artistic work' which is used or capable of being used in relation to any goods or services, the application should include a certification from the Registrar of Trade Marks in terms of the provision to Sub-Section (i) of Section 45 of the Copyright Act, 1957 : N.A.
15. If the work is an 'Artistic work', whether it is registered under the Designs Act 2000 if yes give details. : N.A.
16. If the work is an 'Artistic work', capable of being registered as a design under the Designs Act 2000.whether it has been applied to an article though an industrial process and ,if yes ,the number of times it is reproduced. : N.A.
17. Remarks, if any :
- Diary Number : 5511/2019-CO/L
Date of Application : 11/04/2019
Date of Receipt : 11/04/2019



Extracts from the Register of Copyrights

Dated : 22/08/2019

1. Registration Number : **L-84831/2019**
2. Name, address and nationality of the applicant : KRISHNA INSTITUTE OF MEDICAL SCIENCES "DEEMED TO BE UNIVERSITY", KARAD , KRISHNA INSTITUTE OF MEDICAL SCIENCES "DEEMED TO BE UNIVERSITY", KARAD, MALKAPUR, KARAD, DIST. SATARA, MAHARASHTRA, INDIA-415539 INDIAN
3. Nature of the applicant's interest in the copyright of the work : OWNER
4. Class and description of the work : LITERARY/ DRAMATIC WORK
5. Title of the work : RESEARCH OR REGRESS
6. Language of the work : ENGLISH
7. Name, address and nationality of the author and if the author is deceased, date of his decease : DR. NEELIMA A. MALIK , KRISHNA INSTITUTE OF MEDICAL SCIENCES "DEEMED TO BE UNIVERSITY", KARAD, MALKAPUR, KARAD, DIST. SATARA, MAHARASHTRA, INDIA-415539 INDIAN
8. Whether the work is published or unpublished : UNPUBLISHED
9. Year and country of first publication and name, address and nationality of the publisher : N.A.
10. Years and countries of subsequent publications, if any, and names, addresses and nationalities of the publishers : N.A.
11. Names, addresses and nationalities of the owners of various rights comprising the copyright in the work and the extent of rights held by each, together with particulars of assignments and licences, if any : KRISHNA INSTITUTE OF MEDICAL SCIENCES "DEEMED TO BE UNIVERSITY", KARAD , KRISHNA INSTITUTE OF MEDICAL SCIENCES "DEEMED TO BE UNIVERSITY", KARAD, MALKAPUR, KARAD, DIST. SATARA, MAHARASHTRA, INDIA-415539 INDIAN
12. Names, addresses and nationalities of other persons, if any, authorised to assign or licence of rights comprising the copyright : N.A.
13. If the work is an 'Artistic work', the location of the original work, including name, address and nationality of the person in possession of the work. (In the case of an architectural work, the year of completion of the work should also be shown). : N.A.
14. If the work is an 'Artistic work' which is used or capable of being used in relation to any goods or services, the application should include a certification from the Registrar of Trade Marks in terms of the provision to Sub-Section (i) of Section 45 of the Copyright Act, 1957 : N.A.
15. If the work is an 'Artistic work', whether it is registered under the Designs Act 2000 if yes give details. : N.A.
16. If the work is an 'Artistic work', capable of being registered as a design under the Designs Act 2000.whether it has been applied to an article though an industrial process and ,if yes ,the number of times it is reproduced. : N.A.
17. Remarks, if any :

Diary Number : 9185/2019-CO/L
Date of Application : 14/06/2019
Date of Receipt : 14/06/2019

A



Dated : 02/09/2019

1. Registration Number : **L-85078/2019**
2. Name, address and nationality of the applicant : KRISHNA INSTITUTE OF MEDICAL SCIENCES "DEEMED TO BE UNIVERSITY", KARAD , KRISHNA INSTITUTE OF MEDICAL SCIENCES "DEEMED TO BE UNIVERSITY", KARAD, MALKAPUR, KARAD, DIST. SATARA, MAHARASHTRA, INDIA-415539
INDIAN
3. Nature of the applicant's interest in the copyright of the work : OWNER
4. Class and description of the work : LITERARY/ DRAMATIC WORK
5. Title of the work : WOMEN SATISFACTION SCALE USED AFTER BIRTH PLAN
6. Language of the work : ENGLISH
7. Name, address and nationality of the author and if the author is deceased, date of his decease : MRS. LEKSHMI SUDHISH NAIR , KRISHNA INSTITUTE OF NURSING SCIENCES, KRISHNA INSTITUTE OF MEDICAL SCIENCES "DEEMED TO BE UNIVERSITY", KARAD, MALKAPUR, DIST. SATARA, MAHARASHTRA , INDIA-415539
INDIAN

DR. VAISHALI R.MOHITE , KRISHNA INSTITUTE OF NURSING SCIENCES, KRISHNA INSTITUTE OF MEDICAL SCIENCES "DEEMED TO BE UNIVERSITY", KARAD, MALKAPUR, DIST. SATARA, MAHARASHTRA , INDIA-415539
INDIAN

DR. JYOTI A SALUNKHE , KRISHNA INSTITUTE OF NURSING SCIENCES, KRISHNA INSTITUTE OF MEDICAL SCIENCES "DEEMED TO BE UNIVERSITY", KARAD, MALKAPUR, DIST. SATARA, MAHARASHTRA , INDIA-415539
INDIAN

MRS. FEBA RAJU , KRISHNA INSTITUTE OF NURSING SCIENCES, KRISHNA INSTITUTE OF MEDICAL SCIENCES "DEEMED TO BE UNIVERSITY", KARAD, MALKAPUR, DIST. SATARA, MAHARASHTRA , INDIA-415539
INDIAN
8. Whether the work is published or unpublished : UNPUBLISHED
9. Year and country of first publication and name, address and nationality of the publisher : N.A.
10. Years and countries of subsequent publications, if any, and names, addresses and nationalities of the publishers : N.A.
11. Names, addresses and nationalities of the owners of various rights comprising the copyright in the work and the extent of rights held by each, together with particulars of assignments and licences, if any : KRISHNA INSTITUTE OF MEDICAL SCIENCES "DEEMED TO BE UNIVERSITY", KARAD, KRISHNA INSTITUTE OF MEDICAL SCIENCES "DEEMED TO BE UNIVERSITY", KARAD, MALKAPUR, KARAD, DIST. SATARA, MAHARASHTRA, INDIA-415539
INDIAN
12. Names, addresses and nationalities of other persons, if any, authorised to assign or licence of rights comprising the copyright : N.A.
13. If the work is an 'Artistic work', the location of the original work, including the address and nationality of the person in possession of the work, and in the case of an architectural work, the year of construction (if any) should also be shown). : N.A.
14. If the work is a 'work' which is used or capable of being used in connection with goods or services, the application should be made to the Registrar of Trade Marks in terms of Section 45 of the Copyright Act, 1957. : N.A.
15. If the work is an 'Artistic work', whether it is registered under the Designs Act 2000 if yes give details. : N.A.
16. If the work is an 'Artistic work', capable of being registered as a design under the Designs Act 2000, whether it has been applied to an article though an industrial process and, if yes, the number of times it is reproduced. : N.A.
17. Remarks, if any :



DEPUTY REGISTRAR OF COPYRIGHTS

Diary Number : 5588/2019-CO/L
Date of Application : 12/04/2019
Date of Receipt : 12/04/2019



A handwritten signature in blue ink, appearing to read "M. M. M. S.", is written over a faint rectangular stamp.

DEPUTY REGISTRAR OF COPYRIGHTS



Extracts from the Register of Copyrights

Dated : 16/09/2019

1. Registration Number : **L-85502/2019**
2. Name, address and nationality of the applicant : KRISHNA INSTITUTE OF MEDICAL SCIENCES "DEEMED TO BE UNIVERSITY", KARAD , KRISHNA INSTITUTE OF MEDICAL SCIENCES "DEEMED TO BE UNIVERSITY", KARAD, MALKAPUR, KARAD, DIST. SATARA, MAHARASHTRA, INDIA-415539 INDIAN
3. Nature of the applicant's interest in the copyright of the work : OWNER
4. Class and description of the work : LITERARY/ DRAMATIC WORK
5. Title of the work : SWACHHATA VA DEKHBHAAL [HOUSEKEEPING] KARMACHARI KARYAPADDHATI PUSTIKA
6. Language of the work : MARATHI
7. Name, address and nationality of the author and if the author is deceased, date of his decease : DR. SUNITA H. TATA , DIRECTOR OF NURSING SCIENCES, KRISHNA HOSPITAL, KRISHNA INSTITUTE OF MEDICAL SCIENCES "DEEMED TO BE UNIVERSITY", KARAD, MALKAPUR, KARAD, DIST. SATARA, MAHARASHTRA, INDIA-415539 INDIAN
8. Whether the work is published or unpublished : UNPUBLISHED
9. Year and country of first publication and name, address and nationality of the publisher : N.A.
10. Years and countries of subsequent publications, if any, and names, addresses and nationalities of the publishers : N.A.
11. Names, addresses and nationalities of the owners of various rights comprising the copyright in the work and the extent of rights held by each, together with particulars of assignments and licences, if any : KRISHNA INSTITUTE OF MEDICAL SCIENCES "DEEMED TO BE UNIVERSITY", KARAD , KRISHNA INSTITUTE OF MEDICAL SCIENCES "DEEMED TO BE UNIVERSITY", KARAD, MALKAPUR, KARAD, DIST. SATARA, MAHARASHTRA, INDIA-415539 INDIAN
12. Names, addresses and nationalities of other persons, if any, authorised to assign or licence of rights comprising the copyright : N.A.
13. If the work is an 'Artistic work', the location of the original work, including name, address and nationality of the person in possession of the work. (In the case of an architectural work, the year of completion of the work should also be shown). : N.A.
14. If the work is an 'Artistic work' which is used or capable of being used in relation to any goods or services, the application should include a certification from the Registrar of Trade Marks in terms of the provision to Sub-Section (i) of Section 45 of the Copyright Act, 1957 : N.A.
15. If the work is an 'Artistic work', whether it is registered under the Designs Act 2000 if yes give details. : N.A.
16. If the work is an 'Artistic work', capable of being registered as a design under the Designs Act 2000.whether it has been applied to an article though an industrial process and ,if yes ,the number of times it is reproduced. : N.A.
17. Remarks, if any :



Dated : 04/10/2019

1. Registration Number : **L-86054/2019**
2. Name, address and nationality of the applicant : KRISHNA INSTITUTE OF MEDICAL SCIENCES "DEEMED TO BE UNIVERSITY", KARAD , KRISHNA INSTITUTE OF MEDICAL SCIENCES "DEEMED TO BE UNIVERSITY", KARAD, MALKAPUR, KARAD, DIST. SATARA, MAHARASHTRA, INDIA-415539 INDIAN
3. Nature of the applicant's interest in the copyright of the work : OWNER
4. Class and description of the work : LITERARY/ DRAMATIC WORK
5. Title of the work : MODIFIED AND STRUCTURED LONG ANSWER QUESTIONS FOR MD. MEDICINE
6. Language of the work : ENGLISH
7. Name, address and nationality of the author and if the author is deceased, date of his decease : DR. VIRENDRA CHANDRASHEKHAR PATIL , PROFESSOR & HOD MEDICINE, KRISHNA INSTITUTE OF MEDICAL SCIENCES "DEEMED TO BE UNIVERSITY", KARAD, MALKAPUR, KARAD, DIST. SATARA, MAHARASHTRA, INDIA-415539 INDIAN
8. Whether the work is published or unpublished : UNPUBLISHED
9. Year and country of first publication and name, address and nationality of the publisher : N.A.
10. Years and countries of subsequent publications, if any, and names, addresses and nationalities of the publishers : N.A.
11. Names, addresses and nationalities of the owners of various rights comprising the copyright in the work and the extent of rights held by each, together with particulars of assignments and licences, if any : KRISHNA INSTITUTE OF MEDICAL SCIENCES "DEEMED TO BE UNIVERSITY", KARAD , KRISHNA INSTITUTE OF MEDICAL SCIENCES "DEEMED TO BE UNIVERSITY", KARAD, MALKAPUR, KARAD, DIST. SATARA, MAHARASHTRA, INDIA-415539 INDIAN
12. Names, addresses and nationalities of other persons, if any, authorised to assign or licence of rights comprising the copyright : N.A.
13. If the work is an 'Artistic work', the location of the original work, including name, address and nationality of the person in possession of the work. (In the case of an architectural work, the year of completion of the work should also be shown). : N.A.
14. If the work is an 'Artistic work' which is used or capable of being used in relation to any goods or services, the application should include a certification from the Registrar of Trade Marks in terms of the provision to Sub-Section (i) of Section 45 of the Copyright Act, 1957. : N.A.
15. If the work is an 'Artistic work', whether it is registered under the Designs Act 2000 if yes give details. : N.A.
16. If the work is an 'Artistic work', capable of being registered as a design under the Designs Act 2000.whether it has been applied to an article though an industrial process and ,if yes ,the number of times it is reproduced. : N.A.
17. Remarks, if any :



Dis : 13204/2019-CO/L
19/08/2019
19/08/2019

DEPUTY REGISTRAR OF COPYRIGHTS



Extracts from the Register of Copyrights

Dated : 13/11/2019

1. Registration Number : **L-86938/2019**
2. Name, address and nationality of the applicant : KRISHNA INSTITUTE OF MEDICAL SCIENCES "DEEMED TO BE UNIVERSITY", KARAD , KRISHNA INSTITUTE OF MEDICAL SCIENCES "DEEMED TO BE UNIVERSITY", KARAD, MALKAPUR, KARAD, DIST. SATARA, MAHARASHTRA, INDIA-415539
INDIAN
3. Nature of the applicant's interest in the copyright of the work : OWNER
4. Class and description of the work : LITERARY/ DRAMATIC WORK
5. Title of the work : CO-RELATION OF BALANCE AND BODY MASS INDEX IN CHILDREN
6. Language of the work : ENGLISH
7. Name, address and nationality of the author and if the author is deceased, date of his decease : MANDAR MALAWADE , ASSOCIATE PROFESSOR, PEDIATRIC PHYSIOTHERAPY, KRISHNA COLLEGE OF PHYSIOTHERAPY, KRISHNA INSTITUTE OF MEDICAL SCIENCES "DEEMED TO BE UNIVERSITY", KARAD, MALKAPUR, KARAD, DIST. SATARA, MAHARASHTRA, INDIA-415539
INDIAN
8. Whether the work is published or unpublished : UNPUBLISHED
9. Year and country of first publication and name, address and nationality of the publisher : N.A.
10. Years and countries of subsequent publications, if any, and names, addresses and nationalities of the publishers : N.A.
11. Names, addresses and nationalities of the owners of various rights comprising the copyright in the work and the extent of rights held by each, together with particulars of assignments and licences, if any : KRISHNA INSTITUTE OF MEDICAL SCIENCES "DEEMED TO BE UNIVERSITY", KARAD , KRISHNA INSTITUTE OF MEDICAL SCIENCES "DEEMED TO BE UNIVERSITY", KARAD, MALKAPUR, KARAD, DIST. SATARA, MAHARASHTRA, INDIA-415539
INDIAN
12. Names, addresses and nationalities of other persons, if any, authorised to assign or licence of rights comprising the copyright : N.A.
13. If the work is an 'Artistic work', the location of the original work, including name, address and nationality of the person in possession of the work. (In the case of an architectural work, the year of completion of the work should also be shown). : N.A.
14. If the work is an 'Artistic work' which is used or capable of being used in relation to any goods or services, the application should include a certification from the Registrar of Trade Marks in terms of the provision to Sub-Section (i) of Section 45 of the Copyright Act, 1957 : N.A.
15. If the work is an 'Artistic work', whether it is registered under the Designs Act 2000 if yes give details. : N.A.



Dated : 16/10/2019

1. Registration Number : **L-86346/2019**
2. Name, address and nationality of the applicant : KRISHNA INSTITUTE OF MEDICAL SCIENCES "DEEMED TO BE UNIVERSITY", KARAD , KRISHNA INSTITUTE OF MEDICAL SCIENCES "DEEMED TO BE UNIVERSITY", KARAD, MALKAPUR, KARAD, DIST. SATARA, MAHARASHTRA, INDIA-415539
INDIAN
3. Nature of the applicant's interest in the copyright of the work : OWNER
4. Class and description of the work : LITERARY/ DRAMATIC WORK
5. Title of the work : THREE DIMENSIONAL CHART OF DRUG DOSE FORMULARY FOR INTENSIVE CARE UNIT (ICU)
6. Language of the work : ENGLISH
7. Name, address and nationality of the author and if the author is deceased, date of his decease : DR. VIRENDRA C. PATIL , PROFESSOR & HOD MEDICINE, KRISHNA INSTITUTE OF MEDICAL SCIENCES "DEEMED TO BE UNIVERSITY", KARAD, MAHARASHTRA-415539
INDIAN

ANIKET B. AVHAD , JUNIOR RESIDENT DEPARTMENT OF MEDICINE, KRISHNA INSTITUTE OF MEDICAL SCIENCES "DEEMED TO BE UNIVERSITY", KARAD, MAHARASHTRA-415539
INDIAN
8. Whether the work is published or unpublished : UNPUBLISHED
9. Year and country of first publication and name, address and nationality of the publisher : N.A.
10. Years and countries of subsequent publications, if any, and names, addresses and nationalities of the publishers : N.A.
11. Names, addresses and nationalities of the owners of various rights comprising the copyright in the work and the extent of rights held by each, together with particulars of assignments and licences, if any : KRISHNA INSTITUTE OF MEDICAL SCIENCES "DEEMED TO BE UNIVERSITY", KARAD , KRISHNA INSTITUTE OF MEDICAL SCIENCES "DEEMED TO BE UNIVERSITY", KARAD, MALKAPUR, KARAD, DIST. SATARA, MAHARASHTRA, INDIA-415539
INDIAN
12. Names, addresses and nationalities of other persons, if any, authorised to assign or licence of rights comprising the copyright : N.A.
13. If the work is an 'Artistic work', the location of the original work, including name, address and nationality of the person in possession of the work. (In the case of an architectural work, the year of completion of the work should also be shown). : N.A.
14. If the work is an 'Artistic work' which is used or capable of being used in relation to any goods or services, the application should include a certification from the Registrar of Trade Marks in terms of the provision to Sub-Section (i) of Section 45 of the Copyright Act, 1957. : N.A.
15. If the work is an 'Artistic work', whether it is registered under the Designs Act 2000 if yes give details. : N.A.
16. If the work is an 'Artistic work', capable of being registered as a design under the Designs Act 2000, whether it has been applied to an article, if yes, the number of times : N.A.
17. :



13276/2019-CO/L

20/08/2019

Date of registration : 20/08/2019

DEPUTY REGISTRAR OF COPYRIGHTS



Extracts from the Register of Copyrights

Dated : 13/11/2019

1. Registration Number : **L-86918/2019**
2. Name, address and nationality of the applicant : KRISHNA INSTITUTE OF MEDICAL SCIENCES "DEEMED TO BE UNIVERSITY", KARAD , NH4, PUNE - BANGALORE HIGHWAY, DIST.SATARA, AGASHIVNAGAR, MALKAPUR, MAHARASHTRA-415539
INDIAN
3. Nature of the applicant's interest in the copyright of the work : OWNER
4. Class and description of the work : LITERARY/ DRAMATIC WORK
5. Title of the work : ASSESSMENT OF KNOWLEDGE OF ASTHMATIC PATIENTS REGARDING DISEASE AND PROPER USE OF METERED DOSE INHALERS.
6. Language of the work : ENGLISH
7. Name, address and nationality of the author and if the author is deceased, date of his decease : MRS. JISHA ANNIE GEEVARGHESE , NH4, PUNE - BANGALORE HIGHWAY, DIST.SATARA, AGASHIVNAGAR, MALKAPUR, MAHARASHTRA-415539
INDIAN

DR. R. C. DOIJAD , NH4, PUNE - BANGALORE HIGHWAY, DIST.SATARA, AGASHIVNAGAR, MALKAPUR, MAHARASHTRA 415539-415539
INDIAN
8. Whether the work is published or unpublished : UNPUBLISHED
9. Year and country of first publication and name, address and nationality of the publisher : N.A.
10. Years and countries of subsequent publications, if any, and names, addresses and nationalities of the publishers : N.A.
11. Names, addresses and nationalities of the owners of various rights comprising the copyright in the work and the extent of rights held by each, together with particulars of assignments and licences, if any : KRISHNA INSTITUTE OF MEDICAL SCIENCES "DEEMED TO BE UNIVERSITY", KARAD , NH4, PUNE - BANGALORE HIGHWAY, DIST.SATARA, AGASHIVNAGAR, MALKAPUR, MAHARASHTRA-415539
INDIAN
12. Names, addresses and nationalities of other persons, if any, authorised to assign or licence of rights comprising the copyright : KRISHNA INSTITUTE OF MEDICAL SCIENCES "DEEMED TO BE UNIVERSITY", KARAD , NH4, PUNE - BANGALORE HIGHWAY, DIST.SATARA, AGASHIVNAGAR, MALKAPUR, MAHARASHTRA-415539
INDIAN
13. If the work is an 'Artistic work', the location of the original work, including name, address and nationality of the person in possession of the work. (In the case of an architectural work, the year of completion of the work should also be shown). : N.A.
14. If the work is an 'Artistic work' which is used or capable of being used in relation to any goods or services, the : N.A.



Dated : 03/12/2019

- | | | |
|--|---|---|
| 1. Registration Number | : | L-87470/2019 |
| 2. Name, address and nationality of the applicant | : | KRISHNA INSTITUTE OF MEDICAL SCIENCES "DEEMED TO BE UNIVERSITY", KARAD , NH4, PUNE - BANGALORE HIGHWAY, DIST.SATARA, AGASHIVNAGAR, MALKAPUR, MAHARASHTRA-415539
INDIAN |
| 3. Nature of the applicant's interest in the copyright of the work | : | OWNER |
| 4. Class and description of the work | : | LITERARY/ DRAMATIC WORK |
| 5. Title of the work | : | DENTAL BASE-PLATE FORMING USING SHEET FORMING MACHINE |
| 6. Language of the work | : | ENGLISH |
| 7. Name, address and nationality of the author and if the author is deceased, date of his decease | : | DR. ILA R. PATEL , NH4, PUNE - BANGALORE HIGHWAY, DIST.SATARA, AGASHIVNAGAR, MALKAPUR, MAHARASHTRA-415539
INDIAN |
| 8. Whether the work is published or unpublished | : | UNPUBLISHED |
| 9. Year and country of first publication and name, address and nationality of the publisher | : | N.A. |
| 10. Years and countries of subsequent publications, if any, and names, addresses and nationalities of the publishers | : | N.A. |
| 11. Names, addresses and nationalities of the owners of various rights comprising the copyright in the work and the extent of rights held by each, together with particulars of assignments and licences, if any | : | KRISHNA INSTITUTE OF MEDICAL SCIENCES "DEEMED TO BE UNIVERSITY", KARAD , NH4, PUNE - BANGALORE HIGHWAY, DIST.SATARA, AGASHIVNAGAR, MALKAPUR, MAHARASHTRA-415539
INDIAN |
| 12. Names, addresses and nationalities of other persons, if any, authorised to assign or licence of rights comprising the copyright | : | KRISHNA INSTITUTE OF MEDICAL SCIENCES "DEEMED TO BE UNIVERSITY", KARAD , NH4, PUNE - BANGALORE HIGHWAY, DIST.SATARA, AGASHIVNAGAR, MALKAPUR, MAHARASHTRA-415539
INDIAN |
| 13. If the work is an 'Artistic work', the location of the original work, including name, address and nationality of the person in possession of the work. (In the case of an architectural work, the year of completion of the work should also be shown). | : | N.A. |
| 14. If the work is an 'Artistic work' which is used or capable of being used in relation to any goods or services, the application should include a certification from the Registrar of Trade Marks in terms of the provision to Sub-Section (i) of Section 45 of the Copyright Act, 1957. | : | N.A. |
| 15. If the work is an 'Artistic work', whether it is registered under the Designs Act 2000 if yes give details. | : | N.A. |
| 16. If the work is an 'Artistic work', capable of being registered as a design under the Designs Act 2000.whether it has been applied to an article though an industrial process and ,if yes ,the number of times it is reproduced. | : | N.A. |
| 17. Remarks, if any | : | |

Diary No. 16208/2019-CO/L
Date 16/10/2019
16/10/2019



DEPUTY REGISTRAR OF COPYRIGHTS



Dated : 03/12/2019

1. Registration Number : **L-87465/2019**
2. Name, address and nationality of the applicant : KRISHNA INSTITUTE OF MEDICAL SCIENCES "DEEMED TO BE UNIVERSITY", KARAD , KRISHNA INSTITUTE OF MEDICAL SCIENCES "DEEMED TO BE UNIVERSITY", KARAD, MALKAPUR, KARAD, DIST. SATARA, MAHARASHTRA, INDIA-415539
INDIAN
3. Nature of the applicant's interest in the copyright of the work : OWNER
4. Class and description of the work : LITERARY/ DRAMATIC WORK
5. Title of the work : FETAL OUTCOME SCALE
6. Language of the work : ENGLISH
7. Name, address and nationality of the author and if the author is deceased, date of his decease : MRS. LEKSHMI SUDHISH NAIR , KRISHNA INSTITUTE OF NURSING SCIENCES, KRISHNA INSTITUTE OF MEDICAL SCIENCES "DEEMED TO BE UNIVERSITY", KARAD, MALKAPUR, DIST. SATARA, MAHARASHTRA , INDIA-415539
INDIAN

DR. MRS. JYOTI A SALUNKHE , KRISHNA INSTITUTE OF NURSING SCIENCES, KRISHNA INSTITUTE OF MEDICAL SCIENCES "DEEMED TO BE UNIVERSITY", KARAD, MALKAPUR, DIST. SATARA, MAHARASHTRA , INDIA-415539
INDIAN

MRS. FEBA RAJU , KRISHNA INSTITUTE OF NURSING SCIENCES, KRISHNA INSTITUTE OF MEDICAL SCIENCES "DEEMED TO BE UNIVERSITY", KARAD, MALKAPUR, DIST. SATARA, MAHARASHTRA , INDIA-415539
INDIAN
8. Whether the work is published or unpublished : UNPUBLISHED
9. Year and country of first publication and name, address and nationality of the publisher : N.A.
10. Years and countries of subsequent publications, if any, and names, addresses and nationalities of the publishers : N.A.
11. Names, addresses and nationalities of the owners of various rights comprising the copyright in the work and the extent of rights held by each, together with particulars of assignments and licences, if any : KRISHNA INSTITUTE OF MEDICAL SCIENCES "DEEMED TO BE UNIVERSITY", KARAD , KRISHNA INSTITUTE OF MEDICAL SCIENCES "DEEMED TO BE UNIVERSITY", KARAD, MALKAPUR, KARAD, DIST. SATARA, MAHARASHTRA, INDIA-415539
INDIAN
12. Names, addresses and nationalities of other persons, if any, authorised to assign or licence of rights comprising the copyright : N.A.
13. If the work is an 'Artistic work', the location of the original work, including name, address and nationality of the person in possession of the work. (In the case of an architectural work, the year of completion of the work should also be shown). : N.A.
14. If the work is an 'Artistic work' which is used or capable of being used in relation to any goods or services, the application should include the notification from the Registrar of Trade Marks in terms of the Section (i) of Section 45 of the Copyright Act, : N.A.
15. If the work is an 'Artistic work', whether it is registered under the Copyright Act 1957, give details. : N.A.
16. If the work is an 'Artistic work', capable of being registered as a work under the Copyright Act 2000, whether it has been applied to an industrial process and ,if yes ,the number of times it has been so applied. : N.A.
17. Remarks, if any :

Diary Number : 4978/2019-CO/L
Date of Application : 02/04/2019
Date of Receipt : 02/04/2019

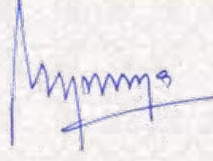
DEPUTY REGISTRAR OF COPYRIGHTS



Dated : 03/12/2019

1. Registration Number : **L-87466/2019**
2. Name, address and nationality of the applicant : KRISHNA INSTITUTE OF MEDICAL SCIENCES "DEEMED TO BE UNIVERSITY", KARAD , KRISHNA INSTITUTE OF MEDICAL SCIENCES "DEEMED TO BE UNIVERSITY", KARAD, MALKAPUR, KARAD, DIST. SATARA, MAHARASHTRA, INDIA-415539
INDIAN
3. Nature of the applicant's interest in the copyright of the work : OWNER
4. Class and description of the work : LITERARY/ DRAMATIC WORK
5. Title of the work : BIRTH PLAN QUESTIONNAIRE
6. Language of the work : ENGLISH
7. Name, address and nationality of the author and if the author is deceased, date of his decease : MRS. LEKSHMI SUDHISH NAIR , KRISHNA INSTITUTE OF NURSING SCIENCES, KRISHNA INSTITUTE OF MEDICAL SCIENCES "DEEMED TO BE UNIVERSITY", KARAD, MALKAPUR, DIST. SATARA, MAHARASHTRA , INDIA-415539
INDIAN

DR. MRS VAISHALI R. MOHITE , KRISHNA INSTITUTE OF NURSING SCIENCES, KRISHNA INSTITUTE OF MEDICAL SCIENCES "DEEMED TO BE UNIVERSITY", KARAD, MALKAPUR, DIST. SATARA, MAHARASHTRA , INDIA-415539
INDIAN

DR. MRS. JYOTI A SALUNKHE , KRISHNA INSTITUTE OF NURSING SCIENCES, KRISHNA INSTITUTE OF MEDICAL SCIENCES "DEEMED TO BE UNIVERSITY", KARAD, MALKAPUR, DIST. SATARA, MAHARASHTRA , INDIA-415539
INDIAN

MRS. FEBA RAJU , KRISHNA INSTITUTE OF NURSING SCIENCES, KRISHNA INSTITUTE OF MEDICAL SCIENCES "DEEMED TO BE UNIVERSITY", KARAD, MALKAPUR, DIST. SATARA, MAHARASHTRA , INDIA-415539
INDIAN
8. Whether the work is published or unpublished : UNPUBLISHED
9. Year and country of first publication and name, address and nationality of the publisher : N.A.
10. Years and countries of subsequent publications, if any, and names, addresses and nationalities of the publishers : N.A.
11. Names, addresses and nationalities of the owners of various rights comprising the copyright in the work and the extent of rights held by each, together with particulars of assignments and licences, if any : KRISHNA INSTITUTE OF MEDICAL SCIENCES "DEEMED TO BE UNIVERSITY", KARAD, KRISHNA INSTITUTE OF MEDICAL SCIENCES "DEEMED TO BE UNIVERSITY", KARAD, MALKAPUR, KARAD, DIST. SATARA, MAHARASHTRA, INDIA-415539
INDIAN
12. Names, addresses and nationalities of other persons, if any, authorised to assign or licence of rights comprising the copyright : N.A.
13. If the work is an 'Artistic work', the location of the original work, including the address and nationality of the person in possession of the work, and in the case of an architectural work, the year of construction (if any) should also be shown). : N.A.
14. If the work is a 'Work of Applied Art' which is used or capable of being used in connection with goods or services, the application should be made to the Registrar of Trade Marks in terms of Section 45 of the Copyright Act, 1957. : N.A.
15. If the work is an 'Artistic work', whether it is registered under the Designs Act 2000 if yes give details. : N.A.
16. If the work is an 'Artistic work', capable of being registered as a design under the Designs Act 2000, whether it has been applied to an article though an industrial process and, if yes, the number of times it is reproduced. : N.A.
17. Remarks, if any :



DEPUTY REGISTRAR OF COPYRIGHTS

Diary Number : 5509/2019-CO/L
Date of Application : 11/04/2019
Date of Receipt : 11/04/2019



A handwritten signature in blue ink, consisting of a series of loops and a horizontal line at the end.

DEPUTY REGISTRAR OF COPYRIGHTS



Dated : 22/11/2019

1. Registration Number : **L-87259/2019**
2. Name, address and nationality of the applicant : KRISHNA INSTITUTE OF MEDICAL SCIENCES "DEEMED TO BE UNIVERSITY", KARAD , NH4, PUNE - BANGALORE HIGHWAY, DIST.SATARA, AGASHIVNAGAR, MALKAPUR, MAHARASHTRA-41553 INDIAN
3. Nature of the applicant's interest in the copyright of the work : OWNER
4. Class and description of the work : LITERARY/ DRAMATIC WORK
5. Title of the work : IMMEDIATE EFFECT OF VARIOUS TYPES OF MUSIC ON VITAL SIGNS IN INFANTS
6. Language of the work : ENGLISH
7. Name, address and nationality of the author and if the author is deceased, date of his decease : MANDAR MALAWADE , NH4, PUNE - BANGALORE HIGHWAY, DIST.SATARA, AGASHIVNAGAR, MALKAPUR, MAHARASHTRA-415539 INDIAN
8. Whether the work is published or unpublished : UNPUBLISHED
9. Year and country of first publication and name, address and nationality of the publisher : N.A.
10. Years and countries of subsequent publications, if any, and names, addresses and nationalities of the publishers : N.A.
11. Names, addresses and nationalities of the owners of various rights comprising the copyright in the work and the extent of rights held by each, together with particulars of assignments and licences, if any : KRISHNA INSTITUTE OF MEDICAL SCIENCES "DEEMED TO BE UNIVERSITY", KARAD , NH4, PUNE - BANGALORE HIGHWAY, DIST.SATARA, AGASHIVNAGAR, MALKAPUR, MAHARASHTRA-41553 INDIAN
12. Names, addresses and nationalities of other persons, if any, authorised to assign or licence of rights comprising the copyright : KRISHNA INSTITUTE OF MEDICAL SCIENCES "DEEMED TO BE UNIVERSITY", KARAD , NH4, PUNE - BANGALORE HIGHWAY, DIST.SATARA, AGASHIVNAGAR, MALKAPUR, MAHARASHTRA-41553 INDIAN
13. If the work is an 'Artistic work', the location of the original work, including name, address and nationality of the person in possession of the work. (In the case of an architectural work, the year of completion of the work should also be shown). : N.A.
14. If the work is an 'Artistic work' which is used or capable of being used in relation to any goods or services, the application should include a certification from the Registrar of Trade Marks in terms of the provision to Sub-Section (i) of Section 45 of the Copyright Act, 1957. : N.A.
15. If the work is an 'Artistic work', whether it is registered under the Designs Act 2000 if yes give details. : N.A.
16. If the work is an 'Artistic work', capable of being registered as a design under the Designs Act 2000.whether it has been applied to an article though an industrial process and ,if yes ,the number of times it is reproduced. : N.A.
17. Remarks, if any :

Diary No. 14523/2019-CO/L

Date 13/09/2019

Date 13/09/2019



DEPUTY REGISTRAR OF COPYRIGHTS



**INTELLECTUAL
PROPERTY INDIA**

एकस्व/PATENTS|अभिकल्प/DESIGNS|
व्यापार चिह्न/TRADE MARKS|भौगोलिक
उपदर्शन/GEOGRAPHICAL INDICATIONS



**भारत सरकार
GOVERNMENT OF INDIA**

एकस्व कार्यालय /THE PATENT OFFICE
बौद्धिक सम्पदा भवन / I.P.O. BUILDING
एंटीप हिल/Antop Hill,
एस.एम. रोड/ S.M.Road,
मुंबई/ Mumbai- 400037
दूरभाष /Tel. No.: (091)(022) 2415365 1
फैक्स/ Fax: 022-24130387
ई मेल/ Email: mumbai-patent@nic.in
वेबसाइट /Website: <http://ipindia.nic.in>

सं. \ No. 201921019049

दिनांक \ Dated the 21/02/2020

सेवा मे, \ To :

Address of Service:- Brainiac IP Solutions B-1, Bhagavadgeeta Apartments, Opp. Manikbaug Petrol Pump, Sinhgad Road, Manikbaug, Pune – 411051, MH India

Email Id:- patent@brainiac.co.in

विषय :- पेटेंट आवेदन संख्या 201921019049 के संबंध में अधिनियम की धारा 43 के तहत पेटेंट अनुदान तथा पेटेंट रजिस्टर में प्रविष्टि की सूचना

Sub :- Intimation of the grant and recordal of patent under section 43 of the Act in respect of patent application no. 201921019049

महोदय/महोदया,

Sir/Madam,

आपको सूचित किया जाता है कि पेटेंट अधिनियम, 1970 की धारा 12 व 13 तथा उस आधार पर बने नियम के तहत उपर्युक्त पेटेंट आवेदन के परीक्षण [व 19/12/2019 को हुई सुनवाई] के उपरान्त एतद्वारा पेटेंट अनुदान किया जाता है। तथा पेटेंट अनुदान की प्रविष्टि 21/02/2020 को पेटेंट रजिस्टर में कर दी गयी है।

This is to Inform you that following the examination of above mentioned patent application under section 12 and 13 of The Patents Act, 1970 and Rules made thereunder [and hearing held on 19/12/2019] a patent is hereby granted and recorded in the Register of Patents on the 21/02/2020. The Patent Certificate is enclosed herewith.

पेटेंट संख्या \ Patent No	: 332628
आवेदक का नाम \ Name Of Applicant	: Krishna Institute of Medical Sciences "Deemed to be University"
पेटेंट दिनांक \ Date of Patent	: 13/05/2019
पूर्विका तिथि \ Priority Date	: 13/05/2019
परीक्षण हेतु अनुरोध दाखिल करने की तिथि \ Filing date of Request for examination	: 25/07/2019
शीर्षक \ Title	: AN ORTHOTIC DEVICE FOR SUPPORTING A SHOULDER JOINT OF A USER
दावों की संख्या \ Number of claims	: 3 (Three)

उपर्युक्त पेटेंट के अनुदान का प्रकाशन अधिनियम की धारा 43 के तहत पेटेंट कार्यालय के आधिकारिक जर्नल में किया जाएगा।

The grant of above mentioned patent will be published in the Official Journal of the patent Office under section 43 of the Act.

पेटेंट अधिनियम 1970 यथा संशोधित पेटेंट (संशोधन) नियम, 2005/ पेटेंट नियम, 2003 यथा संशोधित पेटेंट (संशोधन) नियम, 2016 की धारा 142 की उप-धारा (4) के प्रावधानों के तहत उपरोक्त प्रविष्टि की तिथि से 3 माह के भीतर इस कार्यालय में नवीकरण शुल्क जमा किया जाना चाहिए।

The payment of renewal fee is required to be made at this office within three(3) months from the aforesaid date of recording according to the proviso in sub-section(4) of Section 142 of The Patents Act,1970, as amended by The Patents (Amendment) Act, 2005 / The Patents Rules, 2003 as amended by The Patents (Amendment) Rules, 2016.

Parveen Kumar

(नियंत्रक पेटेंट)

Controller of Patents

टिप्पणी / Note :

1. संशोधित नवीकरण शुल्क हेतु कृपया महानियंत्रक पेटेंट, अभिकल्प एवं व्यापार चिह्न की आधिकारिक वेबसाइट www.ipindia.gov.in पर उपलब्ध पेटेंट (संशोधन) नियम 2016 की प्रथम अनुसूची (शुल्क) देखें।

For revised renewal fees kindly refer to the First Schedule (fees) of The Patents (Amendment) Rules 2016 available on the official website of Controller General of Patents, Designs and Trade Marks www.ipindia.gov.in

2. कार्यालय द्वारा पेटेंट प्रमाणपत्र की कोई भी कागजी प्रति अलग से जारी नहीं की जाएगी।

No hard copy of Patent Certificate shall be issued separately by the office.



INTELLECTUAL
PROPERTY INDIA

PATENTS | DESIGNS | TRADE MARKS
GEOGRAPHICAL INDICATIONS



सत्यमेव जयते

भारत सरकार
GOVERNMENT OF INDIA

पेटेंट कार्यालय
THE PATENT OFFICE

पेटेंट प्रमाणपत्र
PATENT CERTIFICATE
(Rule 74 Of The Patents Rules)

क्रमांक : 022107765
SL No :



पेटेंट सं. / Patent No. : 332628
आवेदन सं. / Application No. : 201921019049
फाइल करने की तारीख / Date of Filing : 13/05/2019
पेटेंटी / Patentee : Krishna Institute of Medical Sciences "Deemed to be University"

प्रमाणित किया जाता है कि पेटेंटी को उपरोक्त आवेदन में यथाप्रकटित AN ORTHOTIC DEVICE FOR SUPPORTING A SHOULDER JOINT OF A USER नामक आविष्कार के लिए, पेटेंट अधिनियम, १९७० के उपबंधों के अनुसार आज तारीख 13th day of May 2019 से बीस वर्ष की अवधि के लिए पेटेंट अनुदत्त किया गया है।

It is hereby certified that a patent has been granted to the patentee for an invention entitled AN ORTHOTIC DEVICE FOR SUPPORTING A SHOULDER JOINT OF A USER as disclosed in the above mentioned application for the term of 20 years from the 13th day of May 2019 in accordance with the provisions of the Patents Act,1970.



अनुदान की तारीख : 21/02/2020
Date of Grant :

पेटेंट नियंत्रक
Controller of Patent

OkSupte

टिप्पणी - इस पेटेंट के नवीकरण के लिए फीस, यदि इसे बनाए रखा जाना है, 13th day of May 2021 को और उसके पश्चात प्रत्येक वर्ष में उसी दिन देय होगी।

Note. - The fees for renewal of this patent, if it is to be maintained will fall / has fallen due on 13th day of May 2021 and on the same day in every year thereafter.



**INTELLECTUAL
PROPERTY INDIA**

एकस्व/PATENTS|अभिकल्प/DESIGNS|
व्यापार चिह्न/TRADE MARKS|भौगोलिक
उपदर्शन/GEOGRAPHICAL INDICATIONS



सत्यमेव जयते

**भारत सरकार
GOVERNMENT OF INDIA**

एकस्व कार्यालय /THE PATENT OFFICE
बौद्धिक सम्पदा भवन / I.P.O. BUILDING
एंटीप हिल/Antop Hill,
एस.एम.रोड/ S.M.Road,
मुंबई/ Mumbai- 400037
दूरभाष /Tel. No.: (091)(022) 24153651
फैक्स/ Fax: 022-24130387
ई मेल/ Email: mumbai-patent@nic.in
वेबसाइट /Website: <http://ipindia.nic.in>

सं. \ No. 201921012466

दिनांक \ Dated the 25/02/2020

सेवा मे, \ To :

Address of Service:- LEX-REGIA, 246, Gandhi Nagar, Nagpur-440 010, Maharashtra, India

Email Id:- mailbox@lexregia.in

विषय :- पेटेंट आवेदन संख्या 201921012466 के संबंध में अधिनियम की धारा 43 के तहत पेटेंट अनुदान तथा पेटेंट रजिस्टर में प्रविष्टि की सूचना

Sub :- Intimation of the grant and recordal of patent under section 43 of the Act in respect of patent application no. 201921012466

महोदय/महोदया,

Sir/Madam,

आपको सूचित किया जाता है कि पेटेंट अधिनियम, 1970 की धारा 12 व 13 तथा उस आधार पर बने नियम के तहत उपर्युक्त पेटेंट आवेदन के परीक्षण [व ----- को हुई सुनवाई] के उपरांत एतद्वारा पेटेंट अनुदान किया जाता है। तथा पेटेंट अनुदान की प्रविष्टि 25/02/2020 को पेटेंट रजिस्टर में कर दी गयी है।

This is to Inform you that following the examination of above mentioned patent application under section 12 and 13 of The Patents Act, 1970 and Rules made thereunder [and hearing held on -----] a patent is hereby granted and recorded in the Register of Patents on the 25/02/2020. The Patent Certificate is enclosed herewith.

पेटेंट संख्या \ Patent No	: 332801
आवेदक का नाम \ Name Of Applicant	: SAMEER SUDHIR KARPE
पेटेंट दिनांक \ Date of Patent	: 29/03/2019
पूर्विका तिथि \ Priority Date	: 29/03/2019
परीक्षण हेतु अनुरोध दाखिल करने की तिथि \ Filing date of Request for examination	: 13/06/2019
शीर्षक \ Title	: "CUSTOMISED ANKLE FOOT ORTHOTIC DEVICE"
दावों की संख्या \ Number of claims	: 3

उपर्युक्त पेटेंट के अनुदान का प्रकाशन अधिनियम की धारा 43 के तहत पेटेंट कार्यालय के आधिकारिक जर्नल में किया जाएगा।

The grant of above mentioned patent will be published in the Official Journal of the patent Office under section 43 of the Act.

पेटेंट अधिनियम 1970 यथा संशोधित पेटेंट (संशोधन) नियम, 2005/ पेटेंट नियम, 2003 यथा संशोधित पेटेंट (संशोधन) नियम, 2016 की धारा 142 की उप-धारा (4) के प्रावधानों के तहत उपरोक्त प्रविष्टि की तिथि से 3 माह के भीतर इस कार्यालय में नवीकरण शुल्क जमा किया जाना चाहिए।

The payment of renewal fee is required to be made at this office within three(3) months from the aforesaid date of recording according to the proviso in sub-section(4) of Section 142 of The Patents Act,1970, as amended by The Patents (Amendment) Act, 2005 / The Patents Rules, 2003 as amended by The Patents (Amendment) Rules, 2016.

Aditya Venkateswara N C

(नियंत्रक पेटेंट)

Controller of Patents

टिप्पणी / Note :

1. संशोधित नवीकरण शुल्क हेतु कृपया महानियंत्रक पेटेंट, अभिकल्प एवं व्यापार चिह्न की आधिकारिक वेबसाइट www.ipindia.gov.in पर उपलब्ध पेटेंट (संशोधन) नियम 2016 की प्रथम अनुसूची (शुल्क) देखें।

For revised renewal fees kindly refer to the First Schedule (fees) of The Patents (Amendment) Rules 2016 available on the official website of Controller General of Patents, Designs and Trade Marks www.ipindia.gov.in

2. कार्यालय द्वारा पेटेंट प्रमाणपत्र की कोई भी कागजी प्रति अलग से जारी नहीं की जाएगी।

No hard copy of Patent Certificate shall be issued separately by the office.



**INTELLECTUAL
PROPERTY INDIA**

PATENTS | DESIGNS | TRADE MARKS
GEOGRAPHICAL INDICATIONS



सत्यमेव जयते

क्रमांक : 022107800
SL No :



भारत सरकार
GOVERNMENT OF INDIA

पेटेंट कार्यालय
THE PATENT OFFICE

पेटेंट प्रमाणपत्र
PATENT CERTIFICATE
(Rule 74 Of The Patents Rules)

पेटेंट सं. / Patent No. : 332801
आवेदन सं. / Application No. : 201921012466
फाइल करने की तारीख / Date of Filing : 29/03/2019
पेटेंटी / Patentee : SAMEER SUDHIR KARPE

प्रमाणित किया जाता है कि पेटेंटी को उपरोक्त आवेदन में यथाप्रकटित "CUSTOMISED ANKLE FOOT ORTHOTIC DEVICE" नामक आविष्कार के लिए, पेटेंट अधिनियम, १९७० के उपबंधों के अनुसार आज तारीख 29th day of March 2019 से बीस वर्ष की अवधि के लिए पेटेंट अनुदत्त किया गया है।

It is hereby certified that a patent has been granted to the patentee for an invention entitled "CUSTOMISED ANKLE FOOT ORTHOTIC DEVICE" as disclosed in the above mentioned application for the term of 20 years from the 29th day of March 2019 in accordance with the provisions of the Patents Act, 1970.



अनुदान की तारीख : 25/02/2020
Date of Grant :

Okrajla
पेटेंट नियंत्रक
Controller of Patent

टिप्पणी - इस पेटेंट के नवीकरण के लिए फीस, यदि इसे बनाए रखा जाना है, 29th day of March 2021 को और उसके पश्चात प्रत्येक वर्ष में उसी दिन देय होगी।

Note. - The fees for renewal of this patent, if it is to be maintained will fall / has fallen due on 29th day of March 2021 and on the same day in every year thereafter.



**INTELLECTUAL
PROPERTY INDIA**

एकस्व/PATENTS | अभिकल्प/DESIGNS |
व्यापार चिह्न/TRADE MARKS | भौगोलिक
उपदर्शन/GEOGRAPHICAL INDICATIONS



सत्यमेव जयते

**भारत सरकार
GOVERNMENT OF INDIA**

एकस्व कार्यालय / THE PATENT OFFICE
बौद्धिक सम्पदा भवन / I.P.O. BUILDING
एंटीप हिल/Antop Hill,
एस.एम. रोड/ S.M. Road,
मुंबई/ Mumbai- 400037
दूरभाष /Tel. No.: (091)(022) 24153651
फैक्स / Fax: 022-24130387
ई मेल/ Email: mumbai-patent@nic.in
वेबसाइट /Website: <http://ipindia.nic.in>

सं. \ No. 201921024231

दिनांक \ Dated the 05/03/2020

सेवा मे, \ To :

Address of Service:- LEX-REGIA, 246, Gandhi Nagar, Nagpur-440 010, Maharashtra, India

Email Id:- mailbox@lexregia.in

विषय :- पेटेंट आवेदन संख्या 201921024231 के संबंध में अधिनियम की धारा 43 के तहत पेटेंट अनुदान तथा पेटेंट रजिस्टर में प्रविष्टि की सूचना
Sub :- Intimation of the grant and recordal of patent under section 43 of the Act in respect of patent application no. 201921024231

महोदय/महोदया,

Sir/Madam,

आपको सूचित किया जाता है कि पेटेंट अधिनियम, 1970 की धारा 12 व 13 तथा उस आधार पर बने नियम के तहत उपर्युक्त पेटेंट आवेदन के परीक्षण [व ----- को हुई सुनवाई] के उपरांत एतद्वारा पेटेंट अनुदान किया जाता है। तथा पेटेंट अनुदान की प्रविष्टि 05/03/2020 को पेटेंट रजिस्टर में कर दी गयी है।

This is to Inform you that following the examination of above mentioned patent application under section 12 and 13 of The Patents Act, 1970 and Rules made thereunder [and hearing held on -----] a patent is hereby granted and recorded in the Register of Patents on the 05/03/2020. The Patent Certificate is enclosed herewith.

पेटेंट संख्या \ Patent No	: 333981
आवेदक का नाम \ Name Of Applicant	: 1.NEELIMA ANIL MALIK 2.SHIVSAGAR TEWARY
पेटेंट दिनांक \ Date of Patent	: 18/06/2019
पूर्विका तिथि \ Priority Date	: 18/06/2019
परीक्षण हेतु अनुरोध दाखिल करने की तिथि \ Filing date of Request for examination	: 21/08/2019
शीर्षक \ Title	: A LIP POSTURE CORRECTOR
दावों की संख्या \ Number of claims	: 6

उपर्युक्त पेटेंट के अनुदान का प्रकाशन अधिनियम की धारा 43 के तहत पेटेंट कार्यालय के आधिकारिक जर्नल में किया जाएगा।

The grant of above mentioned patent will be published in the Official Journal of the patent Office under section 43 of the Act.

पेटेंट अधिनियम 1970 यथा संशोधित पेटेंट (संशोधन) नियम, 2005/ पेटेंट नियम, 2003 यथा संशोधित पेटेंट (संशोधन) नियम, 2016 की धारा 142 की उप-धारा (4) के प्रावधानों के तहत उपरोक्त प्रविष्टि की तिथि से 3 माह के भीतर इस कार्यालय में नवीकरण शुल्क जमा किया जाना चाहिए।

The payment of renewal fee is required to be made at this office within three(3) months from the aforesaid date of recording according to the proviso in sub-section(4) of Section 142 of The Patents Act,1970, as amended by The Patents (Amendment) Act, 2005 / The Patents Rules, 2003 as amended by The Patents (Amendment) Rules, 2016.

Raj Kumar

(नियंत्रक पेटेंट)

Controller of Patents

टिप्पणी / Note :

1. संशोधित नवीकरण शुल्क हेतु कृपया महानियंत्रक पेटेंट, अभिकल्प एवं व्यापार चिह्न की आधिकारिक वेबसाइट www.ipindia.gov.in पर उपलब्ध पेटेंट (संशोधन) नियम 2016 की प्रथम अनुसूची (शुल्क) देखें।

For revised renewal fees kindly refer to the First Schedule (fees) of The Patents (Amendment) Rules 2016 available on the official website of Controller General of Patents, Designs and Trade Marks www.ipindia.gov.in

2. कार्यालय द्वारा पेटेंट प्रमाणपत्र की कोई भी कागजी प्रति अलग से जारी नहीं की जाएगी।

No hard copy of Patent Certificate shall be issued separately by the office.



**INTELLECTUAL
PROPERTY INDIA**

PATENTS | DESIGNS | TRADE MARKS
GEOGRAPHICAL INDICATIONS



सत्यमेव जयते

भारत सरकार
GOVERNMENT OF INDIA

पेटेंट कार्यालय
THE PATENT OFFICE

पेटेंट प्रमाणपत्र
PATENT CERTIFICATE
(Rule 74 Of The Patents Rules)

क्रमांक : 022108011
SL No :



पेटेंट सं. / Patent No. : 333981
आवेदन सं. / Application No. : 201921024231
फाइल करने की तारीख / Date of Filing : 18/06/2019
पेटेंटी / Patentee : 1.NEELIMA ANIL MALIK 2.SHIVSAGAR TEWARY

प्रमाणित किया जाता है कि पेटेंटी को उपरोक्त आवेदन में यथाप्रकटित A LIP POSTURE CORRECTOR नामक आविष्कार के लिए, पेटेंट अधिनियम, १९७० के उपबंधों के अनुसार आज तारीख 18th day of June 2019 से बीस वर्ष की अवधि के लिए पेटेंट अनुदत्त किया गया है।

It is hereby certified that a patent has been granted to the patentee for an invention entitled A LIP POSTURE CORRECTOR as disclosed in the above mentioned application for the term of 20 years from the 18th day of June 2019 in accordance with the provisions of the Patents Act,1970.



अनुदान की तारीख : 05/03/2020
Date of Grant :

पेटेंट नियंत्रक
Controller of Patent

Okrajla

टिप्पणी - इस पेटेंट के नवीकरण के लिए फीस, यदि इसे बनाए रखा जाना है, 18th day of June 2021 को और उसके पश्चात प्रत्येक वर्ष में उसी दिन देय होगी।

Note. - The fees for renewal of this patent, if it is to be maintained will fall / has fallen due on 18th day of June 2021 and on the same day in every year thereafter.



**INTELLECTUAL
PROPERTY INDIA**

एकस्व/PATENTS|अभिकल्प/DESIGNS|
व्यापार चिह्न/TRADE MARKS|भौगोलिक
उपदर्शन/GEOGRAPHICAL INDICATIONS



**भारत सरकार
GOVERNMENT OF INDIA**

एकस्व कार्यालय /THE PATENT OFFICE
बौद्धिक सम्पदा भवन / I.P.O. BUILDING
एंटीप हिल/Antop Hill,
एस.एम.रोड/ S.M.Road,
मुंबई/ Mumbai- 400037
दूरभाष /Tel. No.: (091)(022) 24153651
फैक्स/ Fax: 022-24130387
ई मेल/ Email: mumbai-patent@nic.in
वेबसाइट /Website: <http://ipindia.nic.in>

सं. \ No. 2796/MUM/2013

दिनांक \ Dated the 20/03/2020

सेवा मे, \ To :

Address of Service:- Suneet Baliram Sabale Brainiac IP Solutions B-1, Bhagvadgeeta Apartments, Manikbaug, Opp. Manikbaug Petrol Pump, Sinhgad Road, Pune - 411051 MH. India

Email Id:- patent@brainiac.co.in, advgnbhave@gmail.com, contact@brainiac.co.in

विषय :- पेटेंट आवेदन संख्या 2796/MUM/2013 के संबंध में अधिनियम की धारा 43 के तहत पेटेंट अनुदान तथा पेटेंट रजिस्टर में प्रविष्टि की सूचना

Sub :- Intimation of the grant and recordal of patent under section 43 of the Act in respect of patent application no. 2796/MUM/2013

महोदय/महोदया,

Sir/Madam,

आपको सूचित किया जाता है कि पेटेंट अधिनियम, 1970 की धारा 12 व 13 तथा उस आधार पर बने नियम के तहत उपर्युक्त पेटेंट आवेदन के परीक्षण [व 10/02/2020 को हुई सुनवाई] के उपरांत एतद्वारा पेटेंट अनुदान किया जाता है। तथा पेटेंट अनुदान की प्रविष्टि 20/03/2020 को पेटेंट रजिस्टर में कर दी गयी है।

This is to Inform you that following the examination of above mentioned patent application under section 12 and 13 of The Patents Act, 1970 and Rules made thereunder [and hearing held on 10/02/2020] a patent is hereby granted and recorded in the Register of Patents on the 20/03/2020. The Patent Certificate is enclosed herewith.

पेटेंट संख्या \ Patent No	: 335466
आवेदक का नाम \ Name Of Applicant	: KRISHNA INSTITUTE OF MEDICAL SCIENCES
पेटेंट दिनांक \ Date of Patent	: 28/08/2013
पूर्विका तिथि \ Priority Date	: 28/08/2013
परीक्षण हेतु अनुरोध दाखिल करने की तिथि \ Filing date of Request for examination	: 28/08/2013
शीर्षक \ Title	: SPINAL AND EPIDURAL ANAESTHESIA SIMULATOR
दावों की संख्या \ Number of claims	: 1 TO 6

उपर्युक्त पेटेंट के अनुदान का प्रकाशन अधिनियम की धारा 43 के तहत पेटेंट कार्यालय के आधिकारिक जर्नल में किया जाएगा।

The grant of above mentioned patent will be published in the Official Journal of the patent Office under section 43 of the Act.

पेटेंट अधिनियम 1970 यथा संशोधित पेटेंट (संशोधन) नियम, 2005/ पेटेंट नियम, 2003 यथा संशोधित पेटेंट (संशोधन) नियम, 2016 की धारा 142 की उप-धारा (4) के प्रावधानों के तहत उपरोक्त प्रविष्टि की तिथि से 3 माह के भीतर इस कार्यालय में नवीकरण शुल्क जमा किया जाना चाहिए।

The payment of renewal fee is required to be made at this office within three(3) months from the aforesaid date of recording according to the proviso in sub-section(4) of Section 142 of The Patents Act,1970, as amended by The Patents (Amendment) Act, 2005 / The Patents Rules, 2003 as amended by The Patents (Amendment) Rules, 2016.

Aiswarya P N

(नियंत्रक पेटेंट)

Controller of Patents

टिप्पणी / Note :

1. संशोधित नवीकरण शुल्क हेतु कृपया महानियंत्रक पेटेंट, अभिकल्प एवं व्यापार चिह्न की आधिकारिक वेबसाइट www.ipindia.gov.in पर उपलब्ध पेटेंट (संशोधन) नियम 2016 की प्रथम अनुसूची (शुल्क) देखें।

For revised renewal fees kindly refer to the First Schedule (fees) of The Patents (Amendment) Rules 2016 available on the official website of Controller General of Patents, Designs and Trade Marks www.ipindia.gov.in

2. कार्यालय द्वारा पेटेंट प्रमाणपत्र की कोई भी कागजी प्रति अलग से जारी नहीं की जाएगी।

No hard copy of Patent Certificate shall be issued separately by the office.



**INTELLECTUAL
PROPERTY INDIA**

PATENTS | DESIGNS | TRADE MARKS
GEOGRAPHICAL INDICATIONS



सत्यमेव जयते

भारत सरकार
GOVERNMENT OF INDIA

पेटेंट कार्यालय
THE PATENT OFFICE

पेटेंट प्रमाणपत्र
PATENT CERTIFICATE
(Rule 74 Of The Patents Rules)

क्रमांक : 022108275
SL No :



पेटेंट सं. / Patent No. : 335466
आवेदन सं. / Application No. : 2796/MUM/2013
फाइल करने की तारीख / Date of Filing : 28/08/2013
पेटेंटी / Patentee : KRISHNA INSTITUTE OF MEDICAL SCIENCES

प्रमाणित किया जाता है कि पेटेंटी को उपरोक्त आवेदन में यथाप्रकटित SPINAL AND EPIDURAL ANAESTHESIA SIMULATOR नामक आविष्कार के लिए, पेटेंट अधिनियम, १९७० के उपबंधों के अनुसार आज तारीख 28th day of August 2013 से बीस वर्ष की अवधि के लिए पेटेंट अनुदत्त किया गया है।

It is hereby certified that a patent has been granted to the patentee for an invention entitled SPINAL AND EPIDURAL ANAESTHESIA SIMULATOR as disclosed in the above mentioned application for the term of 20 years from the 28th day of August 2013 in accordance with the provisions of the Patents Act, 1970.



अनुदान की तारीख : 20/03/2020
Date of Grant :

पेटेंट नियंत्रक
Controller of Patent

Okrupte

टिप्पणी - इस पेटेंट के नवीकरण के लिए फीस, यदि इसे बनाए रखा जाना है, 28th day of August 2015 को और उसके पश्चात प्रत्येक वर्ष में उसी दिन देय होगी।

Note. - The fees for renewal of this patent, if it is to be maintained will fall / has fallen due on 28th day of August 2015 and on the same day in every year thereafter.



**INTELLECTUAL
PROPERTY INDIA**

एकस्व/PATENTS|अभिकल्प/DESIGNS|
व्यापार चिह्न/TRADE MARKS|भौगोलिक
उपदर्शन/GEOGRAPHICAL INDICATIONS



सत्यमेव जयते

**भारत सरकार
GOVERNMENT OF INDIA**

एकस्व कार्यालय /THE PATENT OFFICE
बौद्धिक सम्पदा भवन / I.P.O. BUILDING
एंटीप हिल/Antop Hill,
एस.एम. रोड/ S.M.Road,
मुंबई/ Mumbai- 400037
दूरभाष /Tel. No.: (091)(022) 2415365 1
फैक्स/ Fax: 022-24130387
ई मेल/ Email: mumbai-patent@nic.in
वेबसाइट /Website: <http://ipindia.nic.in>

सं. \ No. 201921022288

दिनांक \ Dated the 13/08/2020

सेवा मे, \ To :

Address of Service:- Brainiac IP Solutions B-1, Bhagavadgeeta Apartments, Opp. Manikbaug Petrol Pump, Sinhgad Road, Manikbaug, Pune – 411051, MH India

Email Id:- patent@brainiac.co.in

विषय :- पेटेंट आवेदन संख्या 201921022288 के संबंध में अधिनियम की धारा 43 के तहत पेटेंट अनुदान तथा पेटेंट रजिस्टर में प्रविष्टि की सूचना

Sub :- Intimation of the grant and recordal of patent under section 43 of the Act in respect of patent application no. 201921022288

महोदय/महोदया,

Sir/Madam,

आपको सूचित किया जाता है कि पेटेंट अधिनियम, 1970 की धारा 12 व 13 तथा उस आधार पर बने नियम के तहत उपर्युक्त पेटेंट आवेदन के परीक्षण [व 24/06/2020 को हुई सुनवाई] के उपरान्त एतद्वारा पेटेंट अनुदान किया जाता है। तथा पेटेंट अनुदान की प्रविष्टि 13/08/2020 को पेटेंट रजिस्टर में कर दी गयी है।

This is to Inform you that following the examination of above mentioned patent application under section 12 and 13 of The Patents Act, 1970 and Rules made thereunder [and hearing held on 24/06/2020] a patent is hereby granted and recorded in the Register of Patents on the 13/08/2020. The Patent Certificate is enclosed herewith.

पेटेंट संख्या \ Patent No	: 344097
आवेदक का नाम \ Name Of Applicant	: Krishna Institute of Medical Sciences "Deemed to be University"
पेटेंट दिनांक \ Date of Patent	: 05/06/2019
पूर्विका तिथि \ Priority Date	: 05/06/2019
परीक्षण हेतु अनुरोध दाखिल करने की तिथि \ Filing date of Request for examination	: 06/09/2019
शीर्षक \ Title	: A DEVICE FOR MEASURING TENSION IN A WIRE OF AN ORTHODONTIC BRACES
दावों की संख्या \ Number of claims	: 1-4

उपर्युक्त पेटेंट के अनुदान का प्रकाशन अधिनियम की धारा 43 के तहत पेटेंट कार्यालय के आधिकारिक जर्नल में किया जाएगा।

The grant of above mentioned patent will be published in the Official Journal of the patent Office under section 43 of the Act.

पेटेंट अधिनियम 1970 यथा संशोधित पेटेंट (संशोधन) नियम, 2005/ पेटेंट नियम, 2003 यथा संशोधित पेटेंट (संशोधन) नियम, 2016 की धारा 142 की उप-धारा (4) के प्रावधानों के तहत उपरोक्त प्रविष्टि की तिथि से 3 माह के भीतर इस कार्यालय में नवीकरण शुल्क जमा किया जाना चाहिए।

The payment of renewal fee is required to be made at this office within three(3) months from the aforesaid date of recording according to the proviso in sub-section(4) of Section 142 of The Patents Act,1970, as amended by The Patents (Amendment) Act, 2005 / The Patents Rules, 2003 as amended by The Patents (Amendment) Rules, 2016.

Srekanth K S

(नियंत्रक पेटेंट)

Controller of Patents

टिप्पणी / Note :

1. संशोधित नवीकरण शुल्क हेतु कृपया महानियंत्रक पेटेंट, अभिकल्प एवं व्यापार चिह्न की आधिकारिक वेबसाइट www.ipindia.gov.in पर उपलब्ध पेटेंट (संशोधन) नियम 2016 की प्रथम अनुसूची (शुल्क) देखें।

For revised renewal fees kindly refer to the First Schedule (fees) of The Patents (Amendment) Rules 2016 available on the official website of Controller General of Patents, Designs and Trade Marks www.ipindia.gov.in

2. कार्यालय द्वारा पेटेंट प्रमाणपत्र की कोई भी कागजी प्रति अलग से जारी नहीं की जाएगी।

No hard copy of Patent Certificate shall be issued separately by the office.



**INTELLECTUAL
PROPERTY INDIA**

PATENTS | DESIGNS | TRADE MARKS
GEOGRAPHICAL INDICATIONS



सत्यमेव जयते

क्रमांक : 022109532
SL No :



भारत सरकार
GOVERNMENT OF INDIA

पेटेंट कार्यालय
THE PATENT OFFICE

पेटेंट प्रमाणपत्र
PATENT CERTIFICATE
(Rule 74 Of The Patents Rules)

पेटेंट सं. / Patent No. : 344097
आवेदन सं. / Application No. : 201921022288
फाइल करने की तारीख / Date of Filing : 05/06/2019
पेटेंटी / Patentee : Krishna Institute of Medical Sciences "Deemed to be University"

प्रमाणित किया जाता है कि पेटेंटी को उपरोक्त आवेदन में यथाप्रकटित A DEVICE FOR MEASURING TENSION IN A WIRE OF AN ORTHODONTIC BRACES नामक आविष्कार के लिए, पेटेंट अधिनियम, १९७० के उपबंधों के अनुसार आज तारीख 5th day of June 2019 से बीस वर्ष की अवधि के लिए पेटेंट अनुदत्त किया गया है।

It is hereby certified that a patent has been granted to the patentee for an invention entitled A DEVICE FOR MEASURING TENSION IN A WIRE OF AN ORTHODONTIC BRACES as disclosed in the above mentioned application for the term of 20 years from the 5th day of June 2019 in accordance with the provisions of the Patents Act, 1970.



अनुदान की तारीख : 13/08/2020
Date of Grant :

पेटेंट नियंत्रक
Controller of Patent

OkSupta

टिप्पणी - इस पेटेंट के नवीकरण के लिए फीस, यदि इसे बनाए रखा जाना है, 5th day of June 2021 को और उसके पश्चात प्रत्येक वर्ष में उसी दिन देय होगी।

Note. - The fees for renewal of this patent, if it is to be maintained will fall / has fallen due on 5th day of June 2021 and on the same day in every year thereafter.



**INTELLECTUAL
PROPERTY INDIA**

एकस्व/PATENTS|अभिकल्प/DESIGNS|
व्यापार चिह्न/TRADE MARKS|भौगोलिक
उपदर्शन/GEOGRAPHICAL INDICATIONS



**भारत सरकार
GOVERNMENT OF INDIA**

एकस्व कार्यालय /THE PATENT OFFICE
बौद्धिक सम्पदा भवन / I.P.O. BUILDING
एंटीप हिल/Antop Hill,
एस.एम.रोड/ S.M.Road,
मुंबई/ Mumbai- 400037
दूरभाष /Tel. No.: (091)(022) 24153651
फैक्स/ Fax: 022-24130387
ई मेल/ Email: mumbai-patent@nic.in
वेबसाइट /Website: <http://ipindia.nic.in>

सं. \ No. 202021000282

दिनांक \ Dated the 09/11/2020

सेवा मे, \ To :

Address of Service:- LEX-REGIA, 246, Gandhi Nagar, Nagpur-440 010, Maharashtra, India

Email Id:- mailbox@lexregia.in, royak777@gmail.com

विषय :- पेटेंट आवेदन संख्या 202021000282 के संबंध में अधिनियम की धारा 43 के तहत पेटेंट अनुदान तथा पेटेंट रजिस्टर में प्रविष्टि की सूचना
Sub :- Intimation of the grant and recordal of patent under section 43 of the Act in respect of patent application no. 202021000282

महोदय/महोदया,

Sir/Madam,

आपको सूचित किया जाता है कि पेटेंट अधिनियम, 1970 की धारा 12 व 13 तथा उस आधार पर बने नियम के तहत उपर्युक्त पेटेंट आवेदन के परीक्षण [व 22/10/2020 को हुई सुनवाई] के उपरांत एतद्वारा पेटेंट अनुदान किया जाता है। तथा पेटेंट अनुदान की प्रविष्टि 09/11/2020 को पेटेंट रजिस्टर में कर दी गयी है।

This is to Inform you that following the examination of above mentioned patent application under section 12 and 13 of The Patents Act, 1970 and Rules made thereunder [and hearing held on 22/10/2020] a patent is hereby granted and recorded in the Register of Patents on the 09/11/2020. The Patent Certificate is enclosed herewith.

पेटेंट संख्या \ Patent No	: 351166
आवेदक का नाम \ Name Of Applicant	: PRAKASH MARUTI SOMADE
पेटेंट दिनांक \ Date of Patent	: 03/01/2020
पूर्विका तिथि \ Priority Date	: 03/01/2020
परीक्षण हेतु अनुरोध दाखिल करने की तिथि \ Filing date of Request for examination	: 28/02/2020
शीर्षक \ Title	: "A PROCESS FOR PREPARING 2-CHLORO-N-{{4-(PYRIMIDIN-2-YL SULFAMOYL)PHENYL} CARBAMOTHIOYL} BENZAMIDE AND THE PHARMACEUTICAL UTILITY THEREOF"
दावों की संख्या \ Number of claims	: 1-3

उपर्युक्त पेटेंट के अनुदान का प्रकाशन अधिनियम की धारा 43 के तहत पेटेंट कार्यालय के आधिकारिक जर्नल में किया जाएगा।

The grant of above mentioned patent will be published in the Official Journal of the patent Office under section 43 of the Act.

पेटेंट अधिनियम 1970 यथा संशोधित पेटेंट (संशोधन) नियम, 2005/ पेटेंट नियम, 2003 यथा संशोधित पेटेंट (संशोधन) नियम, 2016 की धारा 142 की उप-धारा (4) के प्रावधानों के तहत उपरोक्त प्रविष्टि की तिथि से 3 माह के भीतर इस कार्यालय में नवीकरण शुल्क जमा किया जाना चाहिए।

The payment of renewal fee is required to be made at this office within three(3) months from the aforesaid date of recording according to the proviso in sub-section(4) of Section 142 of The Patents Act,1970, as amended by The Patents (Amendment) Act, 2005 / The Patents Rules, 2003 as amended by The Patents (Amendment) Rules, 2016.

Manganna Dora Sambha

(नियंत्रक पेटेंट)

Controller of Patents

टिप्पणी / Note :

1. संशोधित नवीकरण शुल्क हेतु कृपया महानियंत्रक पेटेंट, अभिकल्प एवं व्यापार चिह्न की आधिकारिक वेबसाइट www.ipindia.gov.in पर उपलब्ध पेटेंट (संशोधन) नियम 2016 की प्रथम अनुसूची (शुल्क) देखें।

For revised renewal fees kindly refer to the First Schedule (fees) of The Patents (Amendment) Rules 2016 available on the official website of Controller General of Patents, Designs and Trade Marks www.ipindia.gov.in

2. कार्यालय द्वारा पेटेंट प्रमाणपत्र की कोई भी कागजी प्रति अलग से जारी नहीं की जाएगी।

No hard copy of Patent Certificate shall be issued separately by the office.



INTELLECTUAL
PROPERTY INDIA

PATENTS | DESIGNS | TRADE MARKS
GEOGRAPHICAL INDICATIONS



सत्यमेव जयते

भारत सरकार
GOVERNMENT OF INDIA

पेटेंट कार्यालय
THE PATENT OFFICE

पेटेंट प्रमाणपत्र
PATENT CERTIFICATE
(Rule 74 Of The Patents Rules)

क्रमांक : 022110634
SL No :



पेटेंट सं. / Patent No. : 351166
आवेदन सं. / Application No. : 202021000282
फाइल करने की तारीख / Date of Filing : 03/01/2020
पेटेंटी / Patentee : PRAKASH MARUTI SOMADE

प्रमाणित किया जाता है कि पेटेंटी को उपरोक्त आवेदन में यथाप्रकटित "A PROCESS FOR PREPARING 2-CHLORO-N-[[4-(PYRIMIDIN-2-YLSULFAMOYL)PHENYL] CARBAMOTHIOYL] BENZAMIDE AND THE PHARMACEUTICAL UTILITY THEREOF" नामक आविष्कार के लिए, पेटेंट अधिनियम, १९७० के उपबंधों के अनुसार आज तारीख 3rd day of January 2020 से बीस वर्ष की अवधि के लिए पेटेंट अनुदत्त किया गया है।

It is hereby certified that a patent has been granted to the patentee for an invention entitled "A PROCESS FOR PREPARING 2-CHLORO-N-[[4-(PYRIMIDIN-2-YLSULFAMOYL)PHENYL] CARBAMOTHIOYL] BENZAMIDE AND THE PHARMACEUTICAL UTILITY THEREOF" as disclosed in the above mentioned application for the term of 20 years from the 3rd day of January 2020 in accordance with the provisions of the Patents Act,1970.



अनुदान की तारीख : 09/11/2020
Date of Grant :

पेटेंट नियंत्रक
Controller of Patent

OKSupte

टिप्पणी - इस पेटेंट के नवीकरण के लिए फीस, यदि इसे बनाए रखा जाना है, 3rd day of January 2022 को और उसके पश्चात प्रत्येक वर्ष में उसी दिन देय होगी।

Note. - The fees for renewal of this patent, if it is to be maintained will fall / has fallen due on 3rd day of January 2022 and on the same day in every year thereafter.



**INTELLECTUAL
PROPERTY INDIA**

एकस्व/PATENTS | अभिकल्प/DESIGNS |
व्यापार चिह्न/TRADE MARKS | भौगोलिक
उपदर्शन/GEOGRAPHICAL INDICATIONS



**भारत सरकार
GOVERNMENT OF INDIA**

एकस्व कार्यालय / THE PATENT OFFICE
बौद्धिक सम्पदा भवन / I.P.O. BUILDING
एंटीप हिल/Antop Hill,
एस.एम. रोड/ S.M. Road,
मुंबई/ Mumbai- 400037
दूरभाष /Tel. No.: (091)(022) 24153651
फैक्स/ Fax: 022-24130387
ई मेल/ Email: mumbai-patent@nic.in
वेबसाइट /Website: <http://ipindia.nic.in>

सं. \ No. 202021016991

दिनांक \ Dated the 23/11/2020

सेवा मे, \ To :

Address of Service:- Lex-Regia 246, Gandhi Nagar, Nagpur-440 010 Maharashtra, India
Email Id:- mailbox@lexregia.in, royak777@gmail.com

विषय :- पेटेंट आवेदन संख्या 202021016991 के संबंध में अधिनियम की धारा 43 के तहत पेटेंट अनुदान तथा पेटेंट रजिस्टर में प्रविष्टि की सूचना
Sub :- Intimation of the grant and recordal of patent under section 43 of the Act in respect of patent application no. 202021016991

महोदय/महोदया,
Sir/Madam,

आपको सूचित किया जाता है कि पेटेंट अधिनियम, 1970 की धारा 12 व 13 तथा उस आधार पर बने नियम के तहत उपर्युक्त पेटेंट आवेदन के परीक्षण [व ----- को हुई सुनवाई] के उपरान्त एतद्वारा पेटेंट अनुदान किया जाता है। तथा पेटेंट अनुदान की प्रविष्टि 23/11/2020 को पेटेंट रजिस्टर में कर दी गयी है।

This is to Inform you that following the examination of above mentioned patent application under section 12 and 13 of The Patents Act, 1970 and Rules made thereunder [and hearing held on -----] a patent is hereby granted and recorded in the Register of Patents on the 23/11/2020. The Patent Certificate is enclosed herewith.

पेटेंट संख्या \ Patent No	: 351908
आवेदक का नाम \ Name Of Applicant	: JAYANT RAJARAM PAWAR
पेटेंट दिनांक \ Date of Patent	: 20/04/2020
पूर्विका तिथि \ Priority Date	: 20/04/2020
परीक्षण हेतु अनुरोध दाखिल करने की तिथि \ Filing date of Request for examination	: 28/07/2020
शीर्षक \ Title	: "A PACKAGING COMPOSITE AND THE PROCESS FOR PREPARING SUCH COMPOSITE"
दावों की संख्या \ Number of claims	: 09

उपर्युक्त पेटेंट के अनुदान का प्रकाशन अधिनियम की धारा 43 के तहत पेटेंट कार्यालय के आधिकारिक जर्नल में किया जाएगा।
The grant of above mentioned patent will be published in the Official Journal of the patent Office under section 43 of the Act.

पेटेंट अधिनियम 1970 यथा संशोधित पेटेंट (संशोधन) नियम, 2005/ पेटेंट नियम, 2003 यथा संशोधित पेटेंट (संशोधन) नियम, 2016 की धारा 142 की उप-धारा (4) के प्रावधानों के तहत उपरोक्त प्रविष्टि की तिथि से 3 माह के भीतर इस कार्यालय में नवीकरण शुल्क जमा किया जाना चाहिए।
The payment of renewal fee is required to be made at this office within three(3) months from the aforesaid date of recording according to the proviso in sub-section(4) of Section 142 of The Patents Act,1970, as amended by The Patents (Amendment) Act, 2005 / The Patents Rules, 2003 as amended by The Patents (Amendment) Rules, 2016.

Bommineri Ramamuni
(नियंत्रक पेटेंट)
Controller of Patents

टिप्पणी / Note :

1. संशोधित नवीकरण शुल्क हेतु कृपया महानियंत्रक पेटेंट, अभिकल्प एवं व्यापार चिह्न की आधिकारिक वेबसाइट www.ipindia.gov.in पर उपलब्ध पेटेंट (संशोधन) नियम 2016 की प्रथम अनुसूची (शुल्क) देखें।

For revised renewal fees kindly refer to the First Schedule (fees) of The Patents (Amendment) Rules 2016 available on the official website of Controller General of Patents, Designs and Trade Marks www.ipindia.gov.in

2. कार्यालय द्वारा पेटेंट प्रमाणपत्र की कोई भी कागजी प्रति अलग से जारी नहीं की जाएगी।

No hard copy of Patent Certificate shall be issued separately by the office.



**INTELLECTUAL
PROPERTY INDIA**

PATENTS | DESIGNS | TRADE MARKS
GEOGRAPHICAL INDICATIONS



सत्यमेव जयते

क्रमांक : 022110737
SL No :



भारत सरकार
GOVERNMENT OF INDIA

पेटेंट कार्यालय
THE PATENT OFFICE

पेटेंट प्रमाणपत्र
PATENT CERTIFICATE
(Rule 74 Of The Patents Rules)

पेटेंट सं. / Patent No. : 351908
आवेदन सं. / Application No. : 202021016991
फाइल करने की तारीख / Date of Filing : 20/04/2020
पेटेंटी / Patentee : JAYANT RAJARAM PAWAR

प्रमाणित किया जाता है कि पेटेंटी को उपरोक्त आवेदन में यथाप्रकटित "A PACKAGING COMPOSITE AND THE PROCESS FOR PREPARING SUCH COMPOSITE" नामक आविष्कार के लिए, पेटेंट अधिनियम, 1970 के उपबंधों के अनुसार आज तारीख 20th day of April 2020 से बीस वर्ष की अवधि के लिए पेटेंट अनुदत्त किया गया है।

It is hereby certified that a patent has been granted to the patentee for an invention entitled "A PACKAGING COMPOSITE AND THE PROCESS FOR PREPARING SUCH COMPOSITE" as disclosed in the above mentioned application for the term of 20 years from the 20th day of April 2020 in accordance with the provisions of the Patents Act, 1970.



अनुदान की तारीख : 23/11/2020
Date of Grant :

पेटेंट नियंत्रक
Controller of Patent

टिप्पणी - इस पेटेंट के नवीकरण के लिए फीस, यदि इसे बनाए रखा जाना है, 20th day of April 2022 को और उसके पश्चात प्रत्येक वर्ष में उसी दिन देय होगी।

Note - The fees for renewal of this patent, if it is to be maintained will fall / has fallen due on 20th day of April 2022 and on the same day in every year thereafter.



**INTELLECTUAL
PROPERTY INDIA**

एकस्व/PATENTS|अभिकल्प/DESIGNS|
व्यापार चिह्न/TRADE MARKS|भौगोलिक
उपदर्शन/GEOGRAPHICAL INDICATIONS



**भारत सरकार
GOVERNMENT OF INDIA**

एकस्व कार्यालय /THE PATENT OFFICE
बौद्धिक सम्पदा भवन / I.P.O. BUILDING
एंटीप हिल/Antop Hill,
एस.एम.रोड/ S.M.Road,
मुंबई/ Mumbai- 400037
दूरभाष /Tel. No.: (091)(022) 24153651
फैक्स/ Fax: 022-24130387
ई मेल/ Email: mumbai-patent@nic.in
वेबसाइट /Website: <http://ipindia.nic.in>

सं. \ No. 1030/MUM/2013

दिनांक \ Dated the 17/12/2020

सेवा मे, \ To :

Address of Service:- Mrs. Gauri N. Bhawe Patent Agent IN/PA 520, "Chhaya", Plot No. 42, Sangam Society, Padmavati, Pune- Satara Road, Pune 411037. Maharashtra India

Email Id:- advgnbhawe@gmail.com, hari@brainiac.co.in, suneet@brainiac.co.in

विषय :- पेटेंट आवेदन संख्या 1030/MUM/2013 के संबंध में अधिनियम की धारा 43 के तहत पेटेंट अनुदान तथा पेटेंट रजिस्टर में प्रविष्टि की सूचना

Sub :- Intimation of the grant and recordal of patent under section 43 of the Act in respect of patent application no. 1030/MUM/2013

महोदय/महोदया,

Sir/Madam,

आपको सूचित किया जाता है कि पेटेंट अधिनियम, 1970 की धारा 12 व 13 तथा उस आधार पर बने नियम के तहत उपर्युक्त पेटेंट आवेदन के परीक्षण [व 07/10/2020 को हुई सुनवाई] के उपरान्त एतद्वारा पेटेंट अनुदान किया जाता है। तथा पेटेंट अनुदान की प्रविष्टि 17/12/2020 को पेटेंट रजिस्टर में कर दी गयी है।

This is to Inform you that following the examination of above mentioned patent application under section 12 and 13 of The Patents Act, 1970 and Rules made thereunder [and hearing held on 07/10/2020] a patent is hereby granted and recorded in the Register of Patents on the 17/12/2020. The Patent Certificate is enclosed herewith.

पेटेंट संख्या \ Patent No	: 353922
आवेदक का नाम \ Name Of Applicant	: KRISHNA INSTITUTE OF MEDICAL SCIENCES
पेटेंट दिनांक \ Date of Patent	: 23/03/2013
पूर्विका तिथि \ Priority Date	: 23/03/2013
परीक्षण हेतु अनुरोध दाखिल करने की तिथि \ Filing date of Request for examination	: 23/03/2013
शीर्षक \ Title	: A KNEE TRACTION DEVICE
दावों की संख्या \ Number of claims	: 1

उपर्युक्त पेटेंट के अनुदान का प्रकाशन अधिनियम की धारा 43 के तहत पेटेंट कार्यालय के आधिकारिक जर्नल में किया जाएगा।

The grant of above mentioned patent will be published in the Official Journal of the patent Office under section 43 of the Act.

पेटेंट अधिनियम 1970 यथा संशोधित पेटेंट (संशोधन) नियम, 2005/ पेटेंट नियम, 2003 यथा संशोधित पेटेंट (संशोधन) नियम, 2016 की धारा 142 की उप-धारा (4) के प्रावधानों के तहत उपरोक्त प्रविष्टि की तिथि से 3 माह के भीतर इस कार्यालय में नवीकरण शुल्क जमा किया जाना चाहिए।

The payment of renewal fee is required to be made at this office within three(3) months from the aforesaid date of recording according to the proviso in sub-section(4) of Section 142 of The Patents Act,1970, as amended by The Patents (Amendment) Act, 2005 / The Patents Rules, 2003 as amended by The Patents (Amendment) Rules, 2016.

Sreekanth K S

(नियंत्रक पेटेंट)

Controller of Patents

टिप्पणी / Note :

1. संशोधित नवीकरण शुल्क हेतु कृपया महानियंत्रक पेटेंट, अभिकल्प एवं व्यापार चिह्न की आधिकारिक वेबसाइट www.ipindia.gov.in पर उपलब्ध पेटेंट (संशोधन) नियम 2016 की प्रथम अनुसूची (शुल्क) देखें।

For revised renewal fees kindly refer to the First Schedule (fees) of The Patents (Amendment) Rules 2016 available on the official website of Controller General of Patents, Designs and Trade Marks www.ipindia.gov.in

2. कार्यालय द्वारा पेटेंट प्रमाणपत्र की कोई भी कागजी प्रति अलग से जारी नहीं की जाएगी।

No hard copy of Patent Certificate shall be issued separately by the office.



**INTELLECTUAL
PROPERTY INDIA**

PATENTS | DESIGNS | TRADE MARKS
GEOGRAPHICAL INDICATIONS



सत्यमेव जयते

क्रमांक : 022111095
SL No :



भारत सरकार
GOVERNMENT OF INDIA

पेटेंट कार्यालय
THE PATENT OFFICE

पेटेंट प्रमाणपत्र
PATENT CERTIFICATE
(Rule 74 Of The Patents Rules)

पेटेंट सं. / Patent No. : 353922
आवेदन सं. / Application No. : 1030/MUM/2013
फाइल करने की तारीख / Date of Filing : 23/03/2013
पेटेंटी / Patentee : KRISHNA INSTITUTE OF MEDICAL SCIENCES

प्रमाणित किया जाता है कि पेटेंटी को उपरोक्त आवेदन में यथाप्रकटित A KNEE TRACTION DEVICE नामक आविष्कार के लिए, पेटेंट अधिनियम, १९७० के उपबंधों के अनुसार आज तारीख 23rd day of March 2013 से बीस वर्ष की अवधि के लिए पेटेंट अनुदत्त किया गया है।

It is hereby certified that a patent has been granted to the patentee for an invention entitled A KNEE TRACTION DEVICE as disclosed in the above mentioned application for the term of 20 years from the 23rd day of March 2013 in accordance with the provisions of the Patents Act,1970.



अनुदान की तारीख : 17/12/2020
Date of Grant :

पेटेंट नियंत्रक
Controller of Patent

टिप्पणी - इस पेटेंट के नवीकरण के लिए फीस, यदि इसे बनाए रखा जाना है, 23rd day of March 2015 को और उसके पश्चात प्रत्येक वर्ष में उसी दिन देय होगी।

Note. - The fees for renewal of this patent, if it is to be maintained will fall / has fallen due on 23rd day of March 2015 and on the same day in every year thereafter.



सत्यमेव जयते

ORIGINAL

No. 87530

भारत सरकार
GOVERNMENT OF INDIA
पेटेंट कार्यालय
THE PATENT OFFICE

CERTIFICATE OF REGISTRATION OF DESIGN

Design No.	326727-001
Date	03/02/2020
Reciprocity Date*	00:00:00
Country	

Certified that the design of which a copy is annexed hereto has been registered as of the number and date given above in class 24-01 in respect of the application of such design to HAND-FREE DENTAL MIRROR in the name of 1.KARUNA G. PAWASHE, DEPARTMENT NO.11, SCHOOL OF DENTAL SCIENCES, KRISHNA INSTITUTE OF MEDICAL SCIENCES, DEEMED TO BE UNIVERSITY, KARAD -415110, MAHARASHTRA INDIA. 2. SHIVSAGAR TEWARY, DEPARTMENT NO.11, SCHOOL OF DENTAL SCIENCES, KRISHNA INSTITUTE OF MEDICAL SCIENCES, DEEMED TO BE UNIVERSITY, KARAD -415110, MAHARASHTRA INDIA. 3. PRONOB SANYAL, DEPARTMENT NO.11, SCHOOL OF DENTAL SCIENCES, KRISHNA INSTITUTE OF MEDICAL SCIENCES, DEEMED TO BE UNIVERSITY, KARAD -415110, MAHARASHTRA INDIA.

in pursuance of and subject to the provisions of the Designs Act, 2000 and the Designs Rules, 2001.

Oknupla
INTELLECTUAL

Controller General of Patents, Designs and Trade Marks

*The reciprocity date (if any) which has been allowed and the name of the country.
Copyright in the design will subsist for ten years from the date of Registration, and may under the terms of the Act and Rules, be extended for a further period of five years.
This Certificate is not for use in legal proceedings or for obtaining registration abroad

ARGHYA ASHIS ROY,
C/O. LEX REGIA 246, GANDHI NAGAR, NAGPUR-440
010 MAHARASHTRA, INDIA.

Date of Issue 27/04/2020 12:12:24
NF



ORIGINAL

No. 90485

भारत सरकार
GOVERNMENT OF INDIA
पेटेंट कार्यालय
THE PATENT OFFICE

CERTIFICATE OF REGISTRATION OF DESIGN

Design No. 321902-001
Date 23/09/2019 16:07:27
Reciprocity Date*
Country

Certified that the design of which a copy is annexed hereto has been registered as of the number and date given above in class 24-01 in respect of the application of such design to TONGUE - TIE RETRACTOR in the name of ASHOK YADAVRAO KSHIRSAGAR, MEDICAL DIRECTOR OFFICE, KRISHNA MEDICAL COLLEGE AND HOSPITAL, NEAR DHEBEWADI ROAD, MALKAPUR, TAL-KARAD, DIST-SATARA, MAHARASHTRA. 415539

in pursuance of and subject to the provisions of the Designs Act, 2000 and the Designs Rules, 2001.

Okrapla

INTELLECTUAL
PROPERTY INDIA
Controller General of Patents, Designs and Trade Marks

*The reciprocity date (if any) which has been allowed and the name of the country.
Copyright in the design will subsist for ten years from the date of Registration, and may under the terms of the Act and Rules, be extended for a further period of five years.
This Certificate is not for use in legal proceedings or for obtaining registration abroad

DR. USHOSHI GUHA,
C/O LEX REGIA, 246, GANDHINAGAR, OPPOSITE
SHIVAJI SKATING GROUND NAGPUR
MAHARASHTRA PIN-440010

Date of Issue 25/08/2020 12:08:27



ORIGINAL

No. 90980

भारत सरकार
GOVERNMENT OF INDIA
पेटेंट कार्यालय
THE PATENT OFFICE

CERTIFICATE OF REGISTRATION OF DESIGN

Design No. 321904-001
Date 23/09/2019 16:11:21
Reciprocity Date*
Country

Certified that the design of which a copy is annexed hereto has been registered as of the number and date given above in class 24-01 in respect of the application of such design to SELF - RETAINING THYROID RETRACTOR in the name of ASHOK YADAVRAO KSHIRSAGAR, MEDICAL DIRECTOR OFFICE, KRISHNA MEDICAL COLLEGE AND HOSPITAL, NEAR DHEBEWADI ROAD, MALKAPUR, TAL-KARAD, DIST-SATARA, MAHARASHTRA. 415539

in pursuance of and subject to the provisions of the Designs Act, 2000 and the Designs Rules, 2001.

OK Sample

INTELLECTUAL
Controller General of Patents, Designs and Trade Marks

PROPERTY INDIA

*The reciprocity date (if any) which has been allowed and the name of the country.
Copyright in the design will subsist for ten years from the date of Registration, and may under the terms of the Act and Rules, be extended for a further period of five years.
This Certificate is not for use in legal proceedings or for obtaining registration abroad

(DR. USHOSHI GUHA),
C/O LEX REGIA, 246, GANDHINAGAR, OPPOSITE
SHIVAJI SKATING GROUND NAGPUR
MAHARASHTRA PIN-440010

Date of Issue 09/09/2020 15:55:20

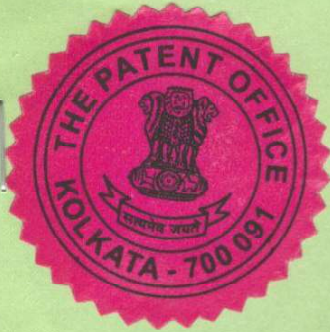

ORIGINAL

No. 91153

भारत सरकार
GOVERNMENT OF INDIA
पेटेंट कार्यालय
THE PATENT OFFICE

CERTIFICATE OF REGISTRATION OF DESIGN

Design No. 324946-001
Date 23/12/2019 16:05:49
Reciprocity Date*
Country

Certified that the design of which a copy is annexed hereto has been registered as of the number and date given above in class 24-01 in respect of the application of such design to DENTAL FLASK in the name of KRISHNA INSTITUTE OF MEDICAL SCIENCES "DEEMED TO BE UNIVERSITY", KARAD. DIST. SATARA (MAHARASHTRA) INDIA - 415539

in pursuance of and subject to the provisions of the Designs Act, 2000 and the Designs Rules, 2001.

Controller General of Patents, Designs and Trade Marks

*The reciprocity date (if any) which has been allowed and the name of the country.

Copyright in the design will subsist for ten years from the date of Registration, and may under the terms of the Act and Rules, be extended for a further period of five years.

This Certificate is not for use in legal proceedings or for obtaining registration abroad

SUNEET BALIRAM SABALE,
BRAINAC IP SOLUTIONS, B-01, BHAGVADGEETA
APARTMENTS, MANIKBAUG, OPP. MANIKBAUG
PETROL PUMP, SINHGAD ROAD, PUNE - 411051,
MH INDIA

Date of Issue 16/09/2020 12:38:19



ORIGINAL

No. 92297

भारत सरकार
GOVERNMENT OF INDIA
पेटेंट कार्यालय
THE PATENT OFFICE

CERTIFICATE OF REGISTRATION OF DESIGN

Design No. 321906-001
Date 23/09/2019 16:14:40
Reciprocity Date*
Country

Certified that the design of which a copy is annexed hereto has been registered as of the number and date given above in class 24-01 in respect of the application of such design to SELF-RETAINING APPENDICECTOMY RETRACTOR in the name of ASHOK YADAVRAO KSHIRSAGAR, MEDICAL DIRECTOR OFFICE, KRISHNA MEDICAL COLLEGE AND HOSPITAL, NEAR DHEBEWADI ROAD, MALKAPUR, TAL-KARAD, DIST-SATARA, MAHARASHTRA. 415539

in pursuance of and subject to the provisions of the Designs Act, 2000 and the Designs Rules, 2001.

OKSupts

INTELLECTUAL
Controller General of Patents, Designs and Trade Marks

PROPERTY INDIA
PATENT RIGHTS AND TRADE MARKS
GEOGRAPHICAL INDICATIONS

*The reciprocity date (if any) which has been allowed and the name of the country.

Copyright in the design will subsist for ten years from the date of Registration, and may under the terms of the Act and Rules, be extended for a further period of five years.

This Certificate is not for use in legal proceedings or for obtaining registration abroad

DR. USHOSHI GUHA,
C/O LEX REGIA, 246, GANDHINAGAR, OPPOSITE
SHIVAJI SKATING GROUND NAGPUR
MAHARASHTRA PIN-440010

Date of Issue 20/10/2020 15:05:40



Controller General of Patents, Designs and Trademarks
Department of Industrial Policy and Promotion
Ministry of Commerce and Industry

Application Details

APPLICATION NUMBER	202021000282
APPLICATION TYPE	ORDINARY APPLICATION
DATE OF FILING	03/01/2020
APPLICANT NAME	PRAKASH MARUTI SOMADE
TITLE OF INVENTION	"A PROCESS FOR PREPARING 2-CHLORO-N-{{[4-(PYRIMIDIN-2-YLSULFAMOYL)PHENYL] CARBAMOTHIOYL} BENZAMIDE AND THE PHARMACEUTICAL UTILITY THEREOF"
FIELD OF INVENTION	CHEMICAL
E-MAIL (As Per Record)	mailbox@lexregia.in
ADDITIONAL-EMAIL (As Per Record)	royak777@gmail.com
E-MAIL (UPDATED Online)	
PRIORITY DATE	NA
REQUEST FOR EXAMINATION DATE	28/02/2020
PUBLICATION DATE (U/S 11A)	10/01/2020

Application Status

APPLICATION STATUS	Application Awaiting Examination
--------------------	---

[View Documents](#)



Controller General of Patents, Designs and Trademarks
Department of Industrial Policy and Promotion
Ministry of Commerce and Industry

Application Details

APPLICATION NUMBER	202021004560
APPLICATION TYPE	ORDINARY APPLICATION
DATE OF FILING	02/02/2020
APPLICANT NAME	PRAKASH MARUTI SOMADE
TITLE OF INVENTION	"A PAIN-RELIEF FORMULATION AND THE METHOD THEREOF"
FIELD OF INVENTION	BIOTECHNOLOGY
E-MAIL (As Per Record)	mailbox@lexregia.in
ADDITIONAL-EMAIL (As Per Record)	royak777@gmail.com
E-MAIL (UPDATED Online)	
PRIORITY DATE	NA
REQUEST FOR EXAMINATION DATE	--
PUBLICATION DATE (U/S 11A)	07/02/2020

Application Status

APPLICATION STATUS	Application Published
--------------------	------------------------------

[View Documents](#)



Controller General of Patents, Designs and Trademarks
Department of Industrial Policy and Promotion
Ministry of Commerce and Industry

Application Details

APPLICATION NUMBER	202021010152
APPLICATION TYPE	ORDINARY APPLICATION
DATE OF FILING	09/03/2020
APPLICANT NAME	The Registrar, Krishna Institute of Medical Sciences , Deemed To Be University
TITLE OF INVENTION	MOISTURE SENSITIVE RESISTANCE BASED NANOCOMPOSITE (SEMICONDUCTOR NPS/AGAR) CHEMICAL NANOSENSOR AND A METHOD FOR FABRICATION THEREOF.
FIELD OF INVENTION	PHYSICS
E-MAIL (As Per Record)	admin@iprsrg.com
ADDITIONAL-EMAIL (As Per Record)	lipi.kaundilya@gmail.com
E-MAIL (UPDATED Online)	
PRIORITY DATE	
REQUEST FOR EXAMINATION DATE	--
PUBLICATION DATE (U/S 11A)	20/03/2020

Application Status

[View Documents](#)

Application Details

APPLICATION NUMBER	202021011729
APPLICATION TYPE	ORDINARY APPLICATION
DATE OF FILING	18/03/2020
APPLICANT NAME	Dr. Prasanna jeet Pramod Nikam
TITLE OF INVENTION	MULTIMODAL SUSTAINED PRESSURE TRIGGER POINT RELEASE PROCESS
FIELD OF INVENTION	BIO-MEDICAL ENGINEERING
E-MAIL (As Per Record)	admin@iprsrg.com
ADDITIONAL-EMAIL (As Per Record)	lipi.kaundilya@gmail.com
E-MAIL (UPDATED Online)	
PRIORITY DATE	
REQUEST FOR EXAMINATION DATE	--
PUBLICATION DATE (U/S 11A)	27/03/2020

Application Status

[View Documents](#)

Application Details

APPLICATION NUMBER	202021016991
APPLICATION TYPE	ORDINARY APPLICATION
DATE OF FILING	20/04/2020
APPLICANT NAME	JAYANT RAJARAM PAWAR
TITLE OF INVENTION	"A PACKAGING COMPOSITE AND THE PROCESS FOR PREPARING SUCH COMPOSITE"
FIELD OF INVENTION	CHEMICAL
E-MAIL (As Per Record)	mailbox@lexregia.in
ADDITIONAL-EMAIL (As Per Record)	royak777@gmail.com
E-MAIL (UPDATED Online)	
PRIORITY DATE	
REQUEST FOR EXAMINATION DATE	--
PUBLICATION DATE (U/S 11A)	22/05/2020

Application Status

[View Documents](#)

Application Details

APPLICATION NUMBER	202021017226
APPLICATION TYPE	ORDINARY APPLICATION
DATE OF FILING	22/04/2020
APPLICANT NAME	1 . PHAPHE, Sandesh 2 . SATHE, Tanuja Tanaji
TITLE OF INVENTION	A DEVICE FOR HOLDING A MINI IMPLANT PLACEMENT GUIDE
FIELD OF INVENTION	BIO-MEDICAL ENGINEERING
E-MAIL (As Per Record)	patent@brainiac.co.in
ADDITIONAL-EMAIL (As Per Record)	suneet@brainiac.co.in
E-MAIL (UPDATED Online)	
PRIORITY DATE	
REQUEST FOR EXAMINATION DATE	--
PUBLICATION DATE (U/S 11A)	19/06/2020

Application Status

[View Documents](#)



Controller General of Patents, Designs and Trademarks
Department of Industrial Policy and Promotion
Ministry of Commerce and Industry

Application Details

APPLICATION NUMBER	202021011715
APPLICATION TYPE	ORDINARY APPLICATION
DATE OF FILING	18/03/2020
APPLICANT NAME	1 . PATIL, Vinaya Rajendra 2 . SAHOO, Kashinath Dharmu
TITLE OF INVENTION	A BELT FOR SYMPHYSIS PUBIS DYSFUNCTION
FIELD OF INVENTION	BIO-MEDICAL ENGINEERING
E-MAIL (As Per Record)	patent@brainiac.co.in
ADDITIONAL-EMAIL (As Per Record)	suneet@brainiac.co.in
E-MAIL (UPDATED Online)	
PRIORITY DATE	
REQUEST FOR EXAMINATION DATE	--
PUBLICATION DATE (U/S 11A)	22/05/2020

Application Status

[View Documents](#)

Application Details

APPLICATION NUMBER	202021024684
APPLICATION TYPE	ORDINARY APPLICATION
DATE OF FILING	12/06/2020
APPLICANT NAME	JAYANT RAJARAM PAWAR
TITLE OF INVENTION	"A METHOD FOR DEPOSITING LAYER OF ZINC OXIDE NANOPARTICLES OVER A SUBSTRATE OF HYGROSCOPIC MATERIAL AS A DIELECTRIC SUBSTRATE AND A SENSOR CONTAINING THE SUBSTRATE FOR DETECTING MOISTURE"
FIELD OF INVENTION	CHEMICAL
E-MAIL (As Per Record)	mailbox@lexregia.in
ADDITIONAL-EMAIL (As Per Record)	royak777@gmail.com
E-MAIL (UPDATED Online)	
PRIORITY DATE	
REQUEST FOR EXAMINATION DATE	15/08/2020
PUBLICATION DATE (U/S 11A)	10/07/2020

Application Status

[View Documents](#)

Application Details

APPLICATION NUMBER	202021012566
APPLICATION TYPE	ORDINARY APPLICATION
DATE OF FILING	23/03/2020
APPLICANT NAME	1 . SARODE, Karishma Rajiv 2 . PAWAR, Renuka Lalit
TITLE OF INVENTION	A TWIN WIRE TUCKER
FIELD OF INVENTION	TEXTILE
E-MAIL (As Per Record)	patent@brainiac.co.in
ADDITIONAL-EMAIL (As Per Record)	suneet@brainiac.co.in
E-MAIL (UPDATED Online)	
PRIORITY DATE	
REQUEST FOR EXAMINATION DATE	11/07/2020
PUBLICATION DATE (U/S 11A)	17/07/2020
FIRST EXAMINATION REPORT DATE	10/08/2020
REPLY TO FER DATE	26/08/2020

Application Status

[View Documents](#)



Controller General of Patents, Designs and Trademarks
Department of Industrial Policy and Promotion
Ministry of Commerce and Industry

Application Details

APPLICATION NUMBER	202021015082
APPLICATION TYPE	ORDINARY APPLICATION
DATE OF FILING	06/04/2020
APPLICANT NAME	NIKAM, Prasannajeet Pramod
TITLE OF INVENTION	A WEARABLE DEVICE FOR ORTHOPAEDIC TREATMENT
FIELD OF INVENTION	BIO-MEDICAL ENGINEERING
E-MAIL (As Per Record)	patent@brainiac.co.in
ADDITIONAL-EMAIL (As Per Record)	suneet@brainiac.co.in
E-MAIL (UPDATED Online)	
PRIORITY DATE	
REQUEST FOR EXAMINATION DATE	14/07/2020
PUBLICATION DATE (U/S 11A)	17/07/2020

Application Status

[View Documents](#)

Application Details

APPLICATION NUMBER	202021027131
APPLICATION TYPE	ORDINARY APPLICATION
DATE OF FILING	26/06/2020
APPLICANT NAME	ROHAN SHARADANAND PHATAK
TITLE OF INVENTION	"A LIPOSOMAL COMPOSITION OF PTEROCARPUS SANTALINUS AND THE PROCESS THEREOF"
FIELD OF INVENTION	CHEMICAL
E-MAIL (As Per Record)	mailbox@lexregia.in
ADDITIONAL-EMAIL (As Per Record)	royak777@gmail.com
E-MAIL (UPDATED Online)	
PRIORITY DATE	
REQUEST FOR EXAMINATION DATE	03/10/2020
PUBLICATION DATE (U/S 11A)	17/07/2020

Application Status

[View Documents](#)

Application Details

APPLICATION NUMBER	202021022694
APPLICATION TYPE	ORDINARY APPLICATION
DATE OF FILING	29/05/2020
APPLICANT NAME	RONAD, Yusuf Ahammed A.
TITLE OF INVENTION	A MEASURING DEVICE FOR ASSESSING AND MEASURING A DENTOALVEOLAR ASYMMETRY
FIELD OF INVENTION	BIO-MEDICAL ENGINEERING
E-MAIL (As Per Record)	patent@brainiac.co.in
ADDITIONAL-EMAIL (As Per Record)	suneet@brainiac.co.in
E-MAIL (UPDATED Online)	
PRIORITY DATE	
REQUEST FOR EXAMINATION DATE	14/07/2020
PUBLICATION DATE (U/S 11A)	31/07/2020

Application Status

[View Documents](#)

Application Details

APPLICATION NUMBER	202021034516
APPLICATION TYPE	ORDINARY APPLICATION
DATE OF FILING	11/08/2020
APPLICANT NAME	PRAKASH MARUTI SOMADE
TITLE OF INVENTION	"A PROCESS FOR PREPARING IMMEDIATE RELEASE TOPICAL FORMULATION OF PTEROCARPUS MARSUPIUM ROXB"
FIELD OF INVENTION	CHEMICAL
E-MAIL (As Per Record)	mailbox@lexregia.in
ADDITIONAL-EMAIL (As Per Record)	royak777@gmail.com
E-MAIL (UPDATED Online)	
PRIORITY DATE	
REQUEST FOR EXAMINATION DATE	--
PUBLICATION DATE (U/S 11A)	28/08/2020

Application Status

[View Documents](#)



Controller General of Patents, Designs and Trademarks
Department of Industrial Policy and Promotion
Ministry of Commerce and Industry

Application Details

APPLICATION NUMBER	202021039623
APPLICATION TYPE	ORDINARY APPLICATION
DATE OF FILING	14/09/2020
APPLICANT NAME	Krishna Institute of Medical Sciences "Deemed To Be University", Karad.
TITLE OF INVENTION	A TRAINING DEVICE FOR THE TREATMENT OF CEREBRAL PALSY
FIELD OF INVENTION	MECHANICAL ENGINEERING
E-MAIL (As Per Record)	patent@brainiac.co.in
ADDITIONAL-EMAIL (As Per Record)	suneet@brainiac.co.in
E-MAIL (UPDATED Online)	
PRIORITY DATE	
REQUEST FOR EXAMINATION DATE	08/12/2020
PUBLICATION DATE (U/S 11A)	02/10/2020

Application Status

APPLICATION STATUS

Application Awaiting Examination

[View Documents](#)



Application Details

APPLICATION NUMBER	202021040721
APPLICATION TYPE	ORDINARY APPLICATION
DATE OF FILING	21/09/2020
APPLICANT NAME	YADAV, Trupti Saurabh
TITLE OF INVENTION	A MANIKIN DEVICE FOR DEMONSTRATING MOVEMENT OF A HUMAN BODY
FIELD OF INVENTION	ELECTRONICS
E-MAIL (As Per Record)	patent@brainiac.co.in
ADDITIONAL-EMAIL (As Per Record)	suneet@brainiac.co.in
E-MAIL (UPDATED Online)	
PRIORITY DATE	
REQUEST FOR EXAMINATION DATE	23/10/2020
PUBLICATION DATE (U/S 11A)	09/10/2020

Application Status

APPLICATION STATUS	FER Issued, Reply not Filed
--------------------	------------------------------------

[View Documents](#)

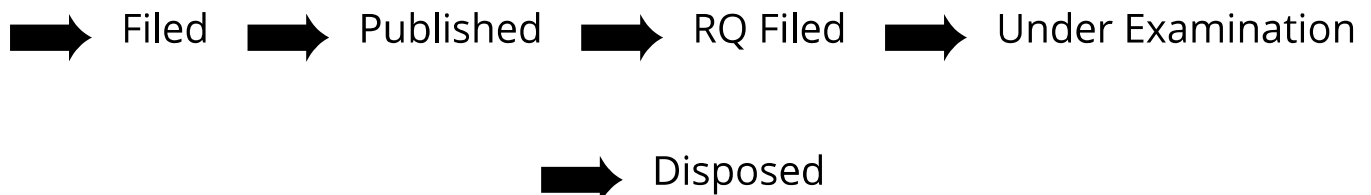

Application Details

APPLICATION NUMBER	202021034156
APPLICATION TYPE	ORDINARY APPLICATION
DATE OF FILING	10/08/2020
APPLICANT NAME	1 . Dr. Suhas P. Deshmukh 2 . Mr. Nikhil K. Bhise 3 . Dr. Archana Gautam
TITLE OF INVENTION	PORTABLE AIR CONDITIONING APPARATUS
FIELD OF INVENTION	ELECTRICAL
E-MAIL (As Per Record)	mail@ideas2ipr.com
ADDITIONAL-EMAIL (As Per Record)	mail@ideas2ipr.com
E-MAIL (UPDATED Online)	
PRIORITY DATE	
REQUEST FOR EXAMINATION DATE	04/11/2020
PUBLICATION DATE (U/S 11A)	06/11/2020

Application Status

APPLICATION STATUS	Application Awaiting Examination
--------------------	---

[View Documents](#)

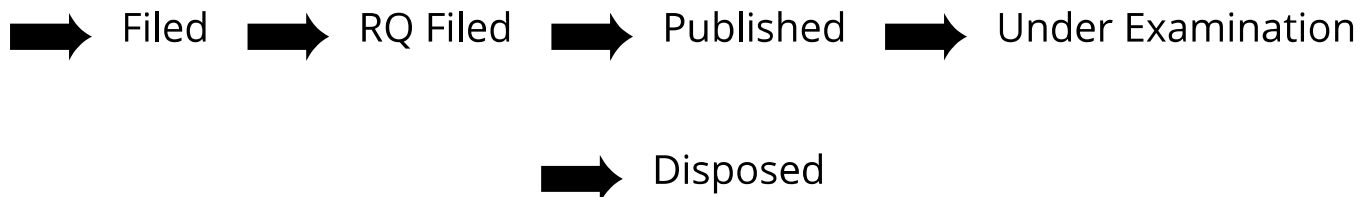



- (51) **International Patent Classification:**
A61F 5/37 (2006.01)
- (21) **International Application Number:**
PCT/IN2018/050720
- (22) **International Filing Date:**
07 November 2018 (07.11.2018)
- (25) **Filing Language:** English
- (26) **Publication Language:** English
- (30) **Priority Data:**
201821031869 25 August 2018 (25.08.2018) IN
- (72) **Inventor; and**
- (71) **Applicant: TATA, Sunita Hoshedar** [IN/IN]; Krishna Institute of Medical Sciences and Krishna Hospital, near Dhebewadi Road, Malkapur, Karad, Maharashtra, Karad 415110 (IN).
- (74) **Agent: ROY, Arghya Ashis;** 246, Gandhi Nagar, Nagpur 440010 (IN).
- (81) **Designated States** (*unless otherwise indicated, for every kind of national protection available*): AE, AG, AL, AM, AO, AT, AU, AZ, BA, BB, BG, BH, BN, BR, BW, BY, BZ, CA, CH, CL, CN, CO, CR, CU, CZ, DE, DJ, DK, DM, DO, DZ, EC, EE, EG, ES, FI, GB, GD, GE, GI, GM, GT, HN, HR, HU, ID, IL, IN, IR, IS, JO, JP, KE, KG, KH, KN, KP, KR, KW, KZ, LA, LC, LK, LR, LS, LU, LY, MA, MD, ME, MG, MK, MN, MW, MX, MY, MZ, NA, NG, NI, NO, NZ, OM, PA, PE, PG, PH, PL, PT, QA, RO, RS, RU, RW, SA, SC, SD, SE, SG, SK, SL, SM, ST, SV, SY, TH, TJ, TM, TN, TR, TT, TZ, UA, UG, US, UZ, VC, VN, ZA, ZM, ZW.
- (84) **Designated States** (*unless otherwise indicated, for every kind of regional protection available*): ARIPO (BW, GH, GM, KE, LR, LS, MW, MZ, NA, RW, SD, SL, ST, SZ, TZ, UG, ZM, ZW), Eurasian (AM, AZ, BY, KG, KZ, RU, TJ, TM), European (AL, AT, BE, BG, CH, CY, CZ, DE, DK, EE, ES, FI, FR, GB, GR, HR, HU, IE, IS, IT, LT, LU, LV, MC, MK, MT, NL, NO, PL, PT, RO, RS, SE, SI, SK, SM,

(54) **Title:** A DEVICE FOR PHYSICALLY RESTRAINING MOVEMENT

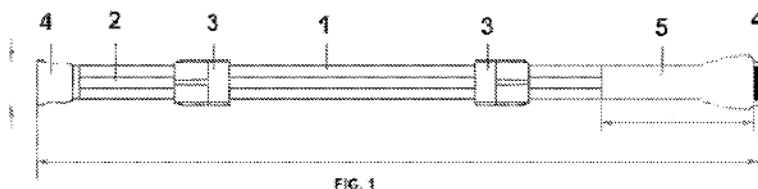

(57) **Abstract:** Disclosed is a device for physically restraining movement comprising first strap (1) and second strap (2); the second strap being placed within the first strap; plurality of buckles (3,4) having a slide release mechanism; the said buckle being made up of polypropylene derivative; a padding unit (5) being made of the sheet which consists of polyethylene vinyl acetate; wherein the first strap being made up a polymer selected from a combination of polyamide: polystyrene: polyacrylamide; wherein polyamide: polystyrene: polyacrylamide is 1.0:0.7:0.5 by weight.





- (51) **International Patent Classification:**
A61M 5/00 (2006.01)
- (21) **International Application Number:**
PCT/IN2018/050721
- (22) **International Filing Date:**
07 November 2018 (07.11.2018)
- (25) **Filing Language:** English
- (26) **Publication Language:** English
- (30) **Priority Data:**
201821031870 25 August 2018 (25.08.2018) IN
- (72) **Inventor; and**
- (71) **Applicant: KARALE, Rajashri Bhagwat** [IN/IN]; Krishna Institute of Nursing Sciences and Krishna Hospital, near Dhebewadi Road, Malkapur, Karad, Maharashtra, Karad 415110 (IN).
- (74) **Agent: ROY, Arghya Ashis;** 246, Gandhi Nagar, Nagpur 440010 (IN).

MG, MK, MN, MW, MX, MY, MZ, NA, NG, NI, NO, NZ, OM, PA, PE, PG, PH, PL, PT, QA, RO, RS, RU, RW, SA, SC, SD, SE, SG, SK, SL, SM, ST, SV, SY, TH, TJ, TM, TN, TR, TT, TZ, UA, UG, US, UZ, VC, VN, ZA, ZM, ZW.

- (84) **Designated States** (unless otherwise indicated, for every kind of regional protection available): ARIPO (BW, GII, GM, KE, LR, LS, MW, MZ, NA, RW, SD, SL, ST, SZ, TZ, UG, ZM, ZW), Eurasian (AM, AZ, BY, KG, KZ, RU, TJ, TM), European (AL, AT, BE, BG, CH, CY, CZ, DE, DK, EE, ES, FI, FR, GB, GR, HR, HU, IE, IS, IT, LT, LU, LV, MC, MK, MT, NL, NO, PL, PT, RO, RS, SE, SI, SK, SM, TR), OAPI (BF, BJ, CF, CG, CI, CM, GA, GN, GQ, GW, KM, ML, MR, NE, SN, TD, TG).

Declarations under Rule 4.17:

— as to the identity of the inventor (Rule 4.17(i))

Published:

— with international search report (Art. 21(3))

- (81) **Designated States** (unless otherwise indicated, for every kind of national protection available): AE, AG, AL, AM, AO, AT, AU, AZ, BA, BB, BG, BH, BN, BR, BW, BY, BZ, CA, CH, CL, CN, CO, CR, CU, CZ, DE, DJ, DK, DM, DO, DZ, EC, EE, EG, ES, FI, GB, GD, GE, GII, GM, GT, IIN, HR, HU, ID, IL, IN, IR, IS, JO, JP, KE, KG, KH, KN, KP, KR, KW, KZ, LA, LC, LK, LR, LS, LU, LY, MA, MD, ME,

(54) **Title:** AN INJECTION GUIDE

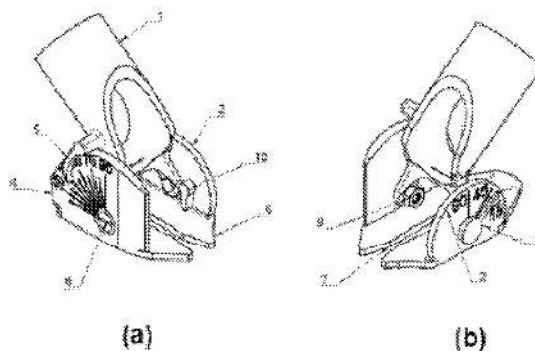

Fig. 1

(57) **Abstract:** Disclosed is an injection guide comprises a holder (1) being cylindrical shape, said holder is having a provision for insertion of a syringe; a base frame (6) means to support for the syringe holder; primary angle unit (2) and secondary angle unit (4), said units having a predetermined degree of angle varying from 10° to 90°; a primary pointer (3) and a secondary pointer (5); the primary pointer and the secondary pointer being connected to primary angle unit (2) and secondary angle unit (4) respectively; a slit (7) being oval shape means to insert the needle; said slit being centrally placed in the said injection guide; wherein the syringe holder (1) being fixed to the primary unit system (2,3) or the secondary unit system (4, 5) such that the needle of the syringe can attain an angle varying from 10° to 90°; wherein the length of the syringe holder is 46.92mm. The said device is used for intravenous, intramuscular, subcutaneous or intradermal injection.





- (51) International Patent Classification:
A61F 5/01 (2006.01)
- (21) International Application Number:
PCT/IN2019/050425
- (22) International Filing Date:
31 May 2019 (31.05.2019)
- (25) Filing Language: English
- (26) Publication Language: English
- (30) Priority Data:
201921012466 29 March 2019 (29.03.2019) IN
- (72) Inventor; and
- (71) Applicant: KARPE, Sameer Sudhir [IN/IN]; Krishna Institute of Physiotherapy, near Dhebewadi Road, Malkapur, Karad 415110 (IN).
- (74) Agent: ROY, Arghya Ashis; Lex Regia, 246, Gandhi Nagar, Nagpur 440010 (IN).
- (81) Designated States (unless otherwise indicated, for every kind of national protection available): AE, AG, AL, AM, AO, AT, AU, AZ, BA, BB, BG, BH, BN, BR, BW, BY, BZ, CA, CL, CN, CO, CR, CU, CZ, DE, DJ, DK, DM, DO, DZ, EC, EE, EG, ES, FI, GB, GD, GE, GI, GM, GT, HN, HR, HU, ID, IL, IN, IR, IS, JO, JP, KE, KG, KH, KN, KP, KR, KW, KZ, LA, LC, LK, LR, LS, LU, LY, MA, MD, ME, MG, MK, MN, MW, MX, MY, MZ, NA, NG, NI, NO, NZ, OM, PA, PE, PG, PH, PL, PT, QA, RO, RS, RU, RW, SA, SC, SD, SE, SG, SK, SL, SM, ST, SV, SY, TH, TJ, TM, TN, TR, TT, TZ, UA, UG, US, UZ, VC, VN, ZA, ZM, ZW.
- (84) Designated States (unless otherwise indicated, for every kind of regional protection available): ARIPO (BW, GH, GM, KE, LR, LS, MW, MZ, NA, RW, SD, SL, ST, SZ, TZ, UG, ZM, ZW), Eurasian (AM, AZ, BY, KG, KZ, RU, TJ,

(54) Title: CUSTOMISED ANKLE FOOT ORTHOTIC DEVICE

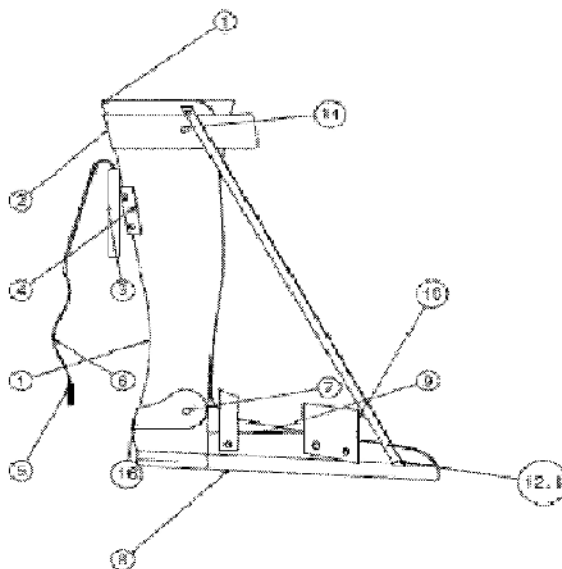

Figure 1a

(57) Abstract: A customised ankle foot orthotic device consist of calf piece (1); calf strap (2); a muscle stimulator (3); stimulator suspension (4) includes a press button with nylon strap; two adhesive electrodes (5); electrical wires (6); hinge joint (7); JBR outsole (8); foot piece (9); snkle strap (10); forfoot strap (11); ring (12.2 and 12.3); adjustable strap (13); press button (14); cold and hot pack pouch (15); a means to provide upward projection (16); & shank (17); characterized in that the adhesive strap being mounted on the the rings (12.2 and 12.3) so as to keep the plantar section of the foot piece (9) in straight position and wherein the adhesive strap being made up by a combination of polyvinyl chloride, polypropylene and polyethylene wherein polyvinyl chloride, polypropylene and polyethylene is 1:1:2 by weight; wherein the cold and hot pack pouch being made up of 40.5 wt% water; 40.5wt% ammonium nitrate, 4wt% hydropropylmethyl cellulose and 15wt% propylene glycol; and wherein the said electrode being made up of a hydrogel



- (51) International Patent Classification:
A61F 5/00 (2006.01)
- (21) International Application Number:
PCT/IB2019/054653
- (22) International Filing Date:
05 June 2019 (05.06.2019)
- (25) Filing Language: English
- (26) Publication Language: English
- (30) Priority Data:
201921019049 13 May 2019 (13.05.2019) IN
- (71) Applicant: KRISHNA INSTITUTE OF MEDICAL SCIENCE"DEEMED TO BE UNIVERSITY" [IN/IN]; NH 4, Near Dhebcwadi Road, Malkapur, Karad -415539, Maharashtra (IN).
- (72) Inventors: MOGHE, Devayani, 124, Cooper Colony, Camp, Sadar Bazar, Satara, Maharashtra - 415001 (IN). SAHOO, Kashinath: Dept of Prosthetics and Orthotics, Krishna Hospital, Malkapur-Karad 415539 (IN).
- (74) Agent: SABALE, Suncet; Brainiac IP Solutions, B-1, Bhagvadgeeta Apartments, Manikbaug, Opp. Manikbaug Petrol Pump, Sinhgad Road, Pune - 411051, MH (IN).
- (81) Designated States (unless otherwise indicated, for every kind of national protection available): AE, AG, AL, AM, AO, AT, AU, AZ, BA, BB, BG, BH, BN, BR, BW, BY, BZ, CA, CH, CL, CN, CO, CR, CU, CZ, DE, DJ, DK, DM, DO, DZ, EC, EE, EG, ES, FI, GB, GD, GE, GH, GM, GT, HN, IIR, IU, ID, IL, IN, IR, IS, JO, JP, KE, KG, KH, KN, KP, KR, KW, KZ, LA, LC, LK, LR, LS, LU, LY, MA, MD, ME, MG, MK, MN, MW, MX, MY, MZ, NA, NG, NI, NO, NZ, OM, PA, PE, PG, PH, PL, PT, QA, RO, RS, RU, RW, SA, SC, SD, SE, SG, SK, SL, SM, ST, SV, SY, TH, TJ, TM, TN, TR, TT, TZ, UA, UG, US, UZ, VC, VN, ZA, ZM, ZW.
- (84) Designated States (unless otherwise indicated, for every kind of regional protection available): ARIPO (BW, GI, GM, KE, LR, LS, MW, MZ, NA, RW, SD, SL, ST, SZ, TZ, UG, ZM, ZW), Eurasian (AM, AZ, BY, KG, KZ, RU, TJ, TM), European (AL, AT, BE, BG, CH, CY, CZ, DE, DK, EE, ES, FI, FR, GB, GR, HR, HU, IE, IS, IT, LT, LU, LV, MC, MK, MT, NL, NO, PL, PT, RO, RS, SE, SI, SK, SM, TR), OAPI (BF, BJ, CF, CG, CI, CM, GA, GN, GQ, GW, KM, ML, MR, NE, SN, TD, TG).
- Declarations under Rule 4.17:
— of inventorship (Rule 4.17(iv))

(54) Title: AN ORTHOTIC DEVICE FOR SUPPORTING A SHOULDER JOINT OF A USER

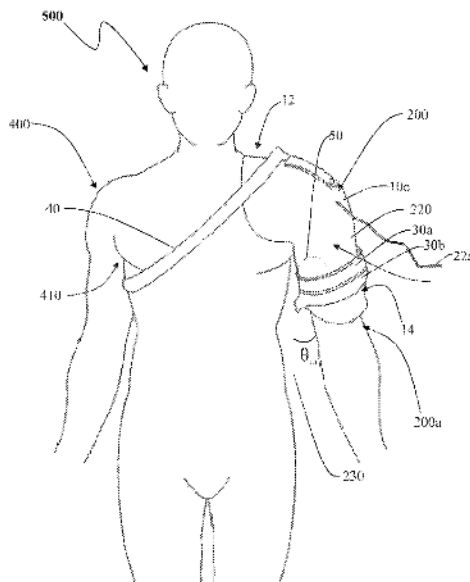

Figure 6

(57) Abstract: The present invention provides an orthotic device 100 for supporting a first shoulder joint 200 of a user 500. The orthotic device 100 includes a rigid support 10, at least one pair of electrodes 30a & 30b, at least one first strap 30 and the at least one-second strap 40. The rigid support 10 is having an outer surface 10a and an inner surface 10b and is resting against the first shoulder joint 200. The at least one first strap 30 is arranged on the rigid support 10 to wrap around an upper arm 220 of the first shoulder joint 200 for securing the orthotic device 100 on the first shoulder joint 200 of the user 500. The at least one-second strap 40 is extending from the rigid support 10 and adapted to wrap around an armpit 410 of a second shoulder joint 400 for efficiently treating a subluxation condition.



- (51) International Patent Classification: *A61C 7/14* (2006.01)
- (72) Inventor: **RONAD, Yusuf Ahammed A.**; Shreeraj Apartment, Flat no 1, Vitteldev society, Koyana vasahath, Malkapur, Maharashtra, Karad 415110 (IN).
- (21) International Application Number: PCT/TB2019/055210
- (74) Agent: **SABALE, Suneet et al.**; Brainiac IP Solutions, Flat No. 01 - B, Bhagvadgeeta Apartments, Manikbaug, Opp. Manikbaug Petrol Pump, Sinhgad Road, Maharashtra, Pune 411051 (IN).
- (22) International Filing Date: 20 June 2019 (20.06.2019)
- (25) Filing Language: English
- (26) Publication Language: English
- (30) Priority Data: 201921022288 05 June 2019 (05.06.2019) IN
- (81) Designated States (unless otherwise indicated, for every kind of national protection available): AE, AG, AL, AM, AO, AT, AU, AZ, BA, BB, BG, BH, BN, BR, BW, BY, BZ, CA, CH, CL, CN, CO, CR, CU, CZ, DE, DJ, DK, DM, DO, DZ, EC, EE, EG, ES, FI, GB, GD, GE, GH, GM, GT, HN, HR, HU, ID, IL, IN, IR, IS, JO, JP, KE, KG, KH, KN, KP, KR, KW, KZ, LA, LC, LK, LR, LS, LU, LY, MA, MD, ME, MG, MK, MN, MW, MX, MY, MZ, NA, NG, NI, NO, NZ, OM, PA, PE, PG, PH, PL, PT, QA, RO, RS, RU, RW, SA,
- (71) Applicant: **KRISHNA INSTITUTE OF MEDICAL SCIENCES "DEEMED TO BE UNIVERSITY"** [IN/IN]; NH 4, Near Dhcbewadi Road, Malkapur, Maharashtra, Karad 415539 (IN).

(54) Title: A DEVICE FOR MEASURING TENSION IN A WIRE OF AN ORTHODONTIC BRACES

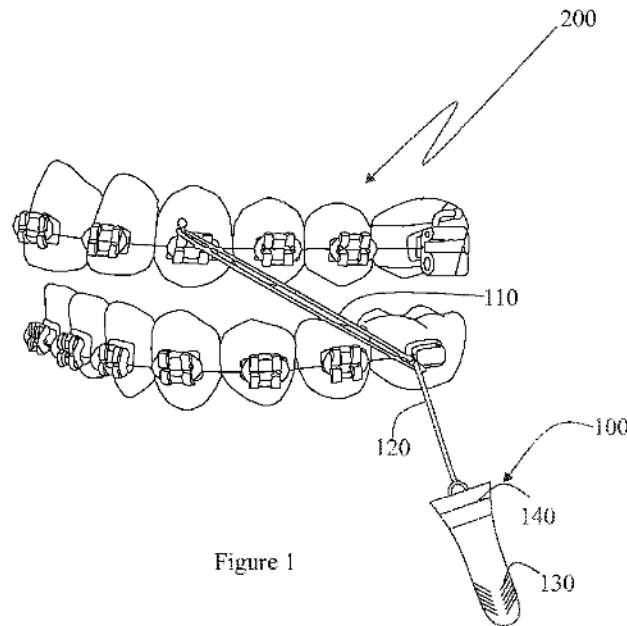

Figure 1

(57) Abstract: Title: A device for measuring tension in a wire of an orthodontic brace. The present invention is to provide a device 100 for measuring tension in a wire 110 of an orthodontic brace 200. The wire 110 is having a closed circumference and capable of being wind in a winding position around brackets 210 of two teeth. The device 100 includes an anchoring member 120, a holding portion 130 and a display 140. The anchoring member 120 is having a first end 120a attachable with the wire 110 in the winding position and a second end 120b attachable with the holding portion 130 of the device 100. The device 100 upon pulling the wire 110 by anchoring the anchoring member 120 along with its length, measures the tension exerted by the wire 110 on the teeth and displays the measured data on the display 140 of the device 100.



WO 2020/245640 A1



(51) International Patent Classification:

A61C 7/00 (2006.01) A63B 23/03 (2006.01)

(21) International Application Number:

PCT/IN2019/050596

(22) International Filing Date:

14 August 2019 (14.08.2019)

(25) Filing Language:

English

(26) Publication Language:

English

(30) Priority Data:

201921024231 18 June 2019 (18.06.2019) IN

(72) Inventors; and

(71) Applicants: **MALIK, Neelima Anil** [IN/IN]; Krishna Institute of Medical Sciences and Krishna Hospital, near Dhebewadi Road, Malkapur, Karad, Maharashtra 415110 (IN). **TEWARY, Shivsagar** [IN/IN]; Krishna Institute of Medical Sciences and Krishna Hospital, near Dhebewadi Road, Malkapur, Karad 415110 (IN).

(74) Agent: **ROY, Arghya Ashis**; Lex Regia, 246, Gandhi Nagar, Nagpur 440010 (IN).

(81) Designated States (unless otherwise indicated, for every kind of national protection available): AE, AG, AL, AM, AO, AT, AU, AZ, BA, BB, BG, BII, BN, BR, BW, BY, BZ, CA, CH, CL, CN, CO, CR, CU, CZ, DE, DJ, DK, DM, DO, DZ, EC, EE, EG, ES, FI, GB, GD, GE, GH, GM, GT, HN, HR, HU, ID, IL, IN, IR, IS, JO, JP, KE, KG, KH, KN, KP, KR, KW, KZ, LA, LC, LK, LR, LS, LU, LY, MA, MD, ME, MG, MK, MN, MW, MX, MY, MZ, NA, NG, NI, NO, NZ, OM, PA, PE, PG, PII, PL, PT, QA, RO, RS, RU, RW, SA,

SC, SD, SE, SG, SK, SL, SM, ST, SV, SY, TH, TJ, TM, TN, TR, TT, TZ, UA, UG, US, UZ, VC, VN, ZA, ZM, ZW.

(84) Designated States (unless otherwise indicated, for every kind of regional protection available): ARIPO (BW, GH, GM, KE, LR, LS, MW, MZ, NA, RW, SD, SL, ST, SZ, TZ, UG, ZM, ZW), Eurasian (AM, AZ, BY, KG, KZ, RU, TJ, TM), European (AL, AT, BE, BG, CH, CY, CZ, DE, DK, EE, ES, FI, FR, GB, GR, HR, HU, IE, IS, IT, LT, LU, LV, MC, MK, MT, NL, NO, PL, PT, RO, RS, SE, SI, SK, SM, TR), OAPI (BF, BJ, CF, CG, CI, CM, GA, GN, GQ, GW, KM, ML, MR, NE, SN, TD, TG).

Declarations under Rule 4.17:

— as to the applicant's entitlement to claim the priority of the earlier application (Rule 4.17(iii))

Published:

— with international search report (Art. 21(3))
— in black and white; the international application as filed contained color or greyscale and is available for download from PATENTSCOPE

(54) Title: A LIP POSTURE CORRECTOR

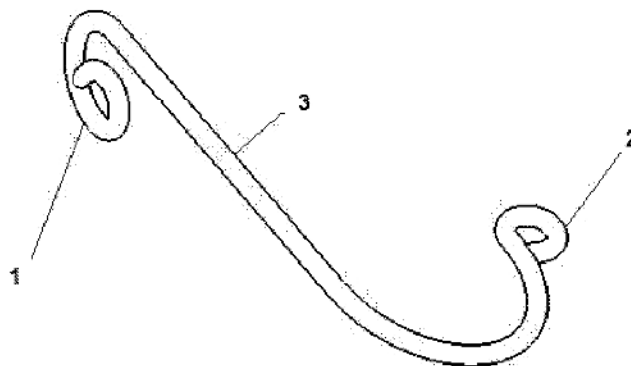

Figure 1

(57) Abstract: Disclosed is a lip posture corrector consist of an intra-oral component (1); an ear support component (2); a connector (3) being positioned between the intraoral component (1) and ear support component (2); wherein the device is made up of a combination of polymethylmethacrylate acrylic resin and copolymer of sodium acrylate and acrylamide in a weight ratio 1:2; wherein the sodium acrylate and acrylamide is 10:90 by weight.





Dated : 01/01/2020

1. Registration Number : **L-88387/2020**
2. Name, address and nationality of the applicant : KRISHNA INSTITUTE OF MEDICAL SCIENCES "DEEMED TO BE UNIVERSITY", KARAD , KRISHNA INSTITUTE OF MEDICAL SCIENCES "DEEMED TO BE UNIVERSITY", KARAD, MALKAPUR, KARAD, DIST. SATARA, MAHARASHTRA, INDIA-415539 INDIAN
3. Nature of the applicant's interest in the copyright of the work : OWNER
4. Class and description of the work : LITERARY/ DRAMATIC WORK
5. Title of the work : PRACTICAL MANUAL OF ANATOMY & PHYSIOLOGY FOR GRADUATE STUDENTS
6. Language of the work : ENGLISH
7. Name, address and nationality of the author and if the author is deceased, date of his decease : DR. MRS. VAISHALI R. MOHITE , DEAN & PRINCIPAL, KRISHNA INSTITUTE OF NURSING SCIENCES, KRISHNA INSTITUTE OF MEDICAL SCIENCES, "DEEMED TO BE UNIVERSITY", KARAD, MAHARASHTRA-415539 INDIAN
MR. PRABHUSWAMI HIREMATH , LECTURER, KRISHNA INSTITUTE OF NURSING SCIENCES, KRISHNA INSTITUTE OF MEDICAL SCIENCES, "DEEMED TO BE UNIVERSITY", KARAD, MAHARASHTRA-415539 INDIAN
8. Whether the work is published or unpublished : UNPUBLISHED
9. Year and country of first publication and name, address and nationality of the publisher : N.A.
10. Years and countries of subsequent publications, if any, and names, addresses and nationalities of the publishers : N.A.
11. Names, addresses and nationalities of the owners of various rights comprising the copyright in the work and the extent of rights held by each, together with particulars of assignments and licences, if any : KRISHNA INSTITUTE OF MEDICAL SCIENCES "DEEMED TO BE UNIVERSITY", KARAD , KRISHNA INSTITUTE OF MEDICAL SCIENCES "DEEMED TO BE UNIVERSITY", KARAD, MALKAPUR, KARAD, DIST. SATARA, MAHARASHTRA, INDIA-415539 INDIAN
12. Names, addresses and nationalities of other persons, if any, authorised to assign or licence of rights comprising the copyright : N.A.
13. If the work is an 'Artistic work', the location of the original work, including name, address and nationality of the person in possession of the work. (In the case of an architectural work, the year of completion of the work should also be shown). : N.A.
14. If the work is an 'Artistic work' which is used or capable of being used in relation to any goods or services, the application should include a certification from the Registrar of Trade Marks in terms of the provision to Sub-Section (i) of Section 45 of the Copyright Act, 1957. : N.A.
15. If the work is an 'Artistic work', whether it is registered under the Designs Act 2000 if yes give details. : N.A.
16. If the work is an 'Artistic work', capable of being registered as a design under the Designs Act 2000, whether it has been applied to an industrial process and ,if yes ,the number of times : N.A.
17. :



18380/2019-CO/L

Date of Receipt : 19/11/2019

Date of Receipt : 19/11/2019

DEPUTY REGISTRAR OF COPYRIGHTS



Dated : 06/01/2020

- | | | |
|---|---|---|
| 1. Registration Number | : | L-88500/2020 |
| 2. Name, address and nationality of the applicant | : | KRISHNA INSTITUTE OF MEDICAL SCIENCES "DEEMED TO BE UNIVERSITY", KRISHNA INSTITUTE OF MEDICAL SCIENCES "DEEMED TO BE UNIVERSITY", KARAD, MALKAPUR, KARAD, DIST. SATARA, MAHARASHTRA, INDIA-415539
INDIAN |
| 3. Nature of the applicant's interest in the copyright of the work | : | OWNER |
| 4. Class and description of the work | : | LITERARY/ DRAMATIC WORK |
| 5. Title of the work | : | ASSESSMENT OF BIOLOGICAL AGE WITH THE HELP OF HEALTH PARAMETERS |
| 6. Language of the work | : | ENGLISH |
| 7. Name, address and nationality of the author and if the author is deceased, date of his decease | : | MR. MAHENDRA ALATE , STATISTICIAN, KRISHNA INSTITUTE OF MEDICAL SCIENCES "DEEMED TO BE UNIVERSITY", KARAD MAHARASHTRA,-415539
INDIAN

DR. R. R. KUMBHAR , DEPARTMENT OF STATISTICS, DATTAJIRAO KADAM ARTS, SCIENCE, COMMERCE COLLEGE, ICHALKARANJI DIST - KOLHAPUR, MAHARASHTRA-416115
INDIAN

DR. S. V. KAKADE , ASSOCIATE PROFESSOR DEPARTMENT OF COMMUNITY MEDICINE, KRISHNA INSTITUTE OF MEDICAL SCIENCES "DEEMED TO BE UNIVERSITY" KARAD, MAHARASHTRA-415539
INDIAN |
| 8. Whether the work is published or unpublished | : | UNPUBLISHED |
| 9. Year and country of first publication and name, address and nationality of the publisher | : | N.A. |
| 10. Years and countries of subsequent publications, if any, and names, addresses and nationalities of the publishers | : | N.A. |
| 11. Names, addresses and nationalities of the owners of various rights comprising the copyright in the work and the extent of rights held by each, together with particulars of assignments and licences, if any | : | KRISHNA INSTITUTE OF MEDICAL SCIENCES "DEEMED TO BE UNIVERSITY", KRISHNA INSTITUTE OF MEDICAL SCIENCES "DEEMED TO BE UNIVERSITY", KARAD, MALKAPUR, KARAD, DIST. SATARA, MAHARASHTRA, INDIA-415539
INDIAN |
| 12. Names, addresses and nationalities of other persons, if any, authorised to assign or licence of rights comprising the copyright | : | N.A. |
| 13. If the work is an 'Artistic work', the location of the original work, including name, address and nationality of the person in possession of the work. (In the case of an architectural work, the year of completion of the work should also be shown). | : | N.A. |
| 14. If the work is an 'Artistic work' which is used or capable of being used in relation to any goods or services, the application should include a certification from the Registrar of Trade Marks in terms of the provisions of Sub-Section (i) of Section 45 of the Copyright Act, 1957. | : | N.A. |
| 15. If the work is an 'Artistic work', whether it is registered under the provisions of the Copyright Act, 1957, give details. | : | N.A. |
| 16. If the work is an 'Artistic work', capable of being registered as a trademark under the provisions of the Trademark Act 2000, whether it has been applied to an article, or to a process, or to a material, or to a service, if yes, the number of times it has been so applied. | : | N.A. |
| 17. Remarks | : | |

Diary Number : 17690/2019-CO/L
Date of Application : 09/11/2019
Date of Receipt : 09/11/2019

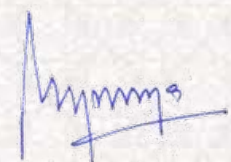

DEPUTY REGISTRAR OF COPYRIGHTS



Dated : 09/01/2020

1. Registration Number : **L-88731/2020**
2. Name, address and nationality of the applicant : KRISHNA INSTITUTE OF MEDICAL SCIENCES "DEEMED TO BE UNIVERSITY", KARAD , KRISHNA INSTITUTE OF MEDICAL SCIENCES "DEEMED TO BE UNIVERSITY", KARAD, MALKAPUR, KARAD, DIST. SATARA, MAHARASHTRA, INDIA-415539
INDIAN
3. Nature of the applicant's interest in the copyright of the work : OWNER
4. Class and description of the work : LITERARY/ DRAMATIC WORK
5. Title of the work : PROCEDURE WITH FLOWCHART FOR PREPARATION, STORAGE AND RELEASE OF RESEALED ERYTHROCYTES
6. Language of the work : ENGLISH
7. Name, address and nationality of the author and if the author is deceased, date of his decease : MRS. ANURADHA NIRANJAN CHIVATE , DEPARTMENT OF PHARMACOLOGY, KRISHNA INSTITUTE OF MEDICAL SCIENCES "DEEMED TO BE UNIVERSITY", MALKAPUR, KARAD, MAHARASHTRA, INDIA.-415539
INDIAN

DR. PRATIBHA S. SALVE , DEPARTMENT OF PHARMACOLOGY, KRISHNA INSTITUTE OF MEDICAL SCIENCES "DEEMED TO BE UNIVERSITY", MALKAPUR, KARAD, MAHARASHTRA, INDIA.-415539
INDIAN

DR. RAJENDRA C. DOJAD , DEAN, KRISHNA INSTITUTE OF PHARMACY, KRISHNA INSTITUTE OF MEDICAL SCIENCES "DEEMED TO BE UNIVERSITY", MALKAPUR, KARAD, MAHARASHTRA, INDIA-415539
INDIAN
8. Whether the work is published or unpublished : UNPUBLISHED
9. Year and country of first publication and name, address and nationality of the publisher : N.A.
10. Years and countries of subsequent publications, if any, and names, addresses and nationalities of the publishers : N.A.
11. Names, addresses and nationalities of the owners of various rights comprising the copyright in the work and the extent of rights held by each, together with particulars of assignments and licences, if any : KRISHNA INSTITUTE OF MEDICAL SCIENCES "DEEMED TO BE UNIVERSITY", KARAD , KRISHNA INSTITUTE OF MEDICAL SCIENCES "DEEMED TO BE UNIVERSITY", KARAD, MALKAPUR, KARAD, DIST. SATARA, MAHARASHTRA, INDIA-415539
INDIAN
12. Names, addresses and nationalities of other persons, if any, authorised to assign or licence of rights comprising the copyright : N.A.
13. If the work is an 'Artistic work', the location of the original work, including name, address and nationality of the person in possession of the work. (In the case of an architectural work, the year of completion of the work should also be shown). : N.A.
14. If the work is an 'Artistic work' which is used or capable of being used in connection to any goods or services, the application should include details of the registration from the Registrar of Trade Marks in terms of Section (i) of Section 45 of the Copyright Act, : N.A.
15. If the work is an 'Artistic work', whether it is registered under the Copyright Act, 1957, give details. : N.A.
16. If the work is an 'Artistic work', capable of being registered as a design under the Designs Act 2000, whether it has been applied to an article of handicraft or industrial process and ,if yes ,the number of times it is registered. : N.A.
17. Remarks, if any :



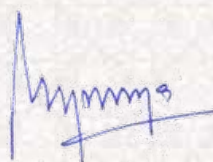

DEPUTY REGISTRAR OF COPYRIGHTS

Diary Number : 18960/2019-CO/L
Date of Application : 27/11/2019
Date of Receipt : 27/11/2019



Dated : 22/01/2020

1. Registration Number : **L-89017/2020**
 2. Name, address and nationality of the applicant : KRISHNA INSTITUTE OF MEDICAL SCIENCES "DEEMED TO BE UNIVERSITY", KARAD , NH4, PUNE - BANGALORE HIGHWAY, DIST.SATARA, AGASHIVNAGAR, MALKAPUR, MAHARASHTRA-415539 INDIAN
 3. Nature of the applicant's interest in the copyright of the work : OWNER
 4. Class and description of the work : LITERARY/ DRAMATIC WORK
 5. Title of the work : FORENSIC E SPRINT
 6. Language of the work : ENGLISH
 7. Name, address and nationality of the author and if the author is deceased, date of his decease : DR. CHANDRAKANT M. KOKATANUR , NH4, PUNE - BANGALORE HIGHWAY, DIST.SATARA, AGASHIVNAGAR, MALKAPUR, MAHARASHTRA-415539 INDIAN
DR. AJAY V. PATIL , NH4, PUNE - BANGALORE HIGHWAY, DIST.SATARA, AGASHIVNAGAR, MALKAPUR, MAHARASHTRA-415539 INDIAN
DR. VINAY BANNUR , NH4, PUNE - BANGALORE HIGHWAY, DIST.SATARA, AGASHIVNAGAR, MALKAPUR, MAHARASHTRA-415539 INDIAN
 8. Whether the work is published or unpublished : UNPUBLISHED
 9. Year and country of first publication and name, address and nationality of the publisher : N.A.
 10. Years and countries of subsequent publications, if any, and names, addresses and nationalities of the publishers : N.A.
 11. Names, addresses and nationalities of the owners of various rights comprising the copyright in the work and the extent of rights held by each, together with particulars of assignments and licences, if any : KRISHNA INSTITUTE OF MEDICAL SCIENCES "DEEMED TO BE UNIVERSITY", KARAD , NH4, PUNE - BANGALORE HIGHWAY, DIST.SATARA, AGASHIVNAGAR, MALKAPUR, MAHARASHTRA-415539 INDIAN
 12. Names, addresses and nationalities of other persons, if any, authorised to assign or licence of rights comprising the copyright : KRISHNA INSTITUTE OF MEDICAL SCIENCES "DEEMED TO BE UNIVERSITY", KARAD , NH4, PUNE - BANGALORE HIGHWAY, DIST.SATARA, AGASHIVNAGAR, MALKAPUR, MAHARASHTRA-415539 INDIAN
 13. If the work is an 'Artistic work', the location of the original work, including name, address and nationality of the person in possession of the work. (In the case of an architectural work, the year of completion of the work should also be shown). : N.A.
 14. If the work is an 'Artistic work' which is used or capable of being used in relation to any goods or services, the application should include a certification from the Registrar of Trade Marks in terms of the provision to Sub-Section (i) of Section 45 of the Copyright Act, 1957. : N.A.
 15. If the work is an 'Artistic work', whether it is registered under the Copyright Act, 1957, give details. : N.A.
 16. If the work is an 'Artistic work', capable of being registered as a trademark under the Trademarks Act 2000, whether it has been applied to an article in the ordinary course of trade, and if yes, the number of times it has been so applied. : N.A.
 17. Registrar : **DEPUTY REGISTRAR OF COPYRIGHTS**
- Diary Number : 16200/2019-CO/L
Date of Application : 16/10/2019
Date of Receipt : 16/10/2019







Dated : 30/01/2020

1. Registration Number : **L-89185/2020**
2. Name, address and nationality of the applicant : KRISHNA INSTITUTE OF MEDICAL SCIENCES "DEEMED TO BE UNIVERSITY", KARAD , NH4, PUNE - BANGALORE HIGHWAY, DIST.SATARA, AGASHIVNAGAR, MALKAPUR, MAHARASHTRA-415539 INDIAN
3. Nature of the applicant's interest in the copyright of the work : OWNER
4. Class and description of the work : LITERARY/ DRAMATIC WORK
5. Title of the work : PREFORMULATION CONSIDERATIONS
6. Language of the work : ENGLISH
7. Name, address and nationality of the author and if the author is deceased, date of his decease : DR.RAJENDRA CHANDRASHEKHAR DOJAD , KRISHNA INSTITUTE OF MEDICAL SCIENCES "DEEMED TO BE UNIVERSITY", KARAD-415539 INDIAN
8. Whether the work is published or unpublished : UNPUBLISHED
9. Year and country of first publication and name, address and nationality of the publisher : N.A.
10. Years and countries of subsequent publications, if any, and names, addresses and nationalities of the publishers : N.A.
11. Names, addresses and nationalities of the owners of various rights comprising the copyright in the work and the extent of rights held by each, together with particulars of assignments and licences, if any : KRISHNA INSTITUTE OF MEDICAL SCIENCES "DEEMED TO BE UNIVERSITY", KARAD , NH4, PUNE - BANGALORE HIGHWAY, DIST.SATARA, AGASHIVNAGAR, MALKAPUR, MAHARASHTRA-415539 INDIAN
12. Names, addresses and nationalities of other persons, if any, authorised to assign or licence of rights comprising the copyright : KRISHNA INSTITUTE OF MEDICAL SCIENCES "DEEMED TO BE UNIVERSITY", KARAD , NH4, PUNE - BANGALORE HIGHWAY, DIST.SATARA, AGASHIVNAGAR, MALKAPUR, MAHARASHTRA-415539 INDIAN
13. If the work is an 'Artistic work', the location of the original work, including name, address and nationality of the person in possession of the work. (In the case of an architectural work, the year of completion of the work should also be shown). : N.A.
14. If the work is an 'Artistic work' which is used or capable of being used in relation to any goods or services, the application should include a certification from the Registrar of Trade Marks in terms of the provision to Sub-Section (i) of Section 45 of the Copyright Act, 1957. : N.A.
15. If the work is an 'Artistic work', whether it is registered under the Designs Act 2000 if yes give details. : N.A.
16. If the work is an 'Artistic work', capable of being registered as a design under the Designs Act 2000.whether it has been applied to an article though an industrial process and ,if yes ,the number of times it is reproduced. : N.A.
17. Remarks :



19422/2019-CO/L
04/12/2019
04/12/2019

DEPUTY REGISTRAR OF COPYRIGHTS



Dated : 13/02/2020

1. Registration Number : **L-89476/2020**
2. Name, address and nationality of the applicant : KRISHNA INSTITUTE OF MEDICAL SCIENCES "DEEMED TO BE UNIVERSITY", KARAD , NH4, PUNE - BANGALORE HIGHWAY, DIST.SATARA, AGASHIVNAGAR, MALKAPUR, MAHARASHTRA-415539 INDIAN
3. Nature of the applicant's interest in the copyright of the work : OWNER
4. Class and description of the work : LITERARY/ DRAMATIC WORK
5. Title of the work : PROCESS WITH STANDARDIZED FLOW CHART FOR ISOLATION OF GLYCERYLPHOSPHATE ACID FROM LIQUORICE
6. Language of the work : ENGLISH
7. Name, address and nationality of the author and if the author is deceased, date of his decease : MR. NIRANJAN D. CHIVATE , NH4, PUNE - BANGALORE HIGHWAY, DIST.SATARA, AGASHIVNAGAR, MALKAPUR, MAHARASHTRA-415539 INDIAN
MRS. SHUBHANGI A. PATIL , NH4, PUNE - BANGALORE HIGHWAY, DIST.SATARA, AGASHIVNAGAR, MALKAPUR, MAHARASHTRA-415539 INDIAN
DR. KIRAN A. WADKAR , NH4, PUNE - BANGALORE HIGHWAY, DIST.SATARA, AGASHIVNAGAR, MALKAPUR, MAHARASHTRA-415539 INDIAN
8. Whether the work is published or unpublished : UNPUBLISHED
9. Year and country of first publication and name, address and nationality of the publisher : N.A.
10. Years and countries of subsequent publications, if any, and names, addresses and nationalities of the publishers : N.A.
11. Names, addresses and nationalities of the owners of various rights comprising the copyright in the work and the extent of rights held by each, together with particulars of assignments and licences, if any : KRISHNA INSTITUTE OF MEDICAL SCIENCES "DEEMED TO BE UNIVERSITY", KARAD , NH4, PUNE - BANGALORE HIGHWAY, DIST.SATARA, AGASHIVNAGAR, MALKAPUR, MAHARASHTRA-415539 INDIAN
12. Names, addresses and nationalities of other persons, if any, authorised to assign or licence of rights comprising the copyright : KRISHNA INSTITUTE OF MEDICAL SCIENCES "DEEMED TO BE UNIVERSITY", KARAD , NH4, PUNE - BANGALORE HIGHWAY, DIST.SATARA, AGASHIVNAGAR, MALKAPUR, MAHARASHTRA-415539 INDIAN
13. If the work is an 'Artistic work', the location of the original work, including name, address and nationality of the person in possession of the work. (In the case of an architectural work, the year of completion of the work should also be shown). : N.A.
14. If the work is an 'Artistic work' which is used or capable of being used in relation to any goods or services, the application should include a declaration from the Registrar of Trade Marks in terms of the provisions of Section (i) of Section 45 of the Copyright Act, 1957. : N.A.
15. If the work is an 'Artistic work', whether it is registered under the provisions of the Trade Marks Act, 1999, give details. : N.A.
16. If the work is an 'Artistic work', capable of being registered as a trademark under the Trade Marks Act 2000, whether it has been applied to an industrial process and, if yes, the number of times it has been so applied. : N.A.
17. Remarks, if any :

Diary Number : 18923/2019-CO/L
Date of Application : 27/11/2019
Date of Receipt : 27/11/2019

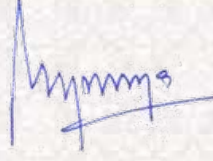
DEPUTY REGISTRAR OF COPYRIGHTS



Dated : 24/02/2020

1. Registration Number : **L-89708/2020**
2. Name, address and nationality of the applicant : KRISHNA INSTITUTE OF MEDICAL SCIENCES "DEEMED TO BE UNIVERSITY", KARAD , KRISHNA INSTITUTE OF MEDICAL SCIENCES "DEEMED TO BE UNIVERSITY", KARAD, MALKAPUR, KARAD, DIST. SATARA, MAHARASHTRA, INDIA-415539
INDIAN
3. Nature of the applicant's interest in the copyright of the work : OWNER
4. Class and description of the work : LITERARY/ DRAMATIC WORK
5. Title of the work : QUESTIONNAIRE ON VARICOSE VEINS RISK FACTORS AND PREVENTION
6. Language of the work : ENGLISH
7. Name, address and nationality of the author and if the author is deceased, date of his decease : MISS. BLESSY SUSAN BABU , KRISHNA INSTITUTE OF NURSING SCIENCES, KRISHNA INSTITUTE OF MEDICAL SCIENCES "DEEMED TO BE UNIVERSITY", KARAD, MALKAPUR, KARAD, DIST. SATARA, MAHARASHTRA, INDIA-415539
INDIAN
DR. VAISHALI R. MOHITE , KRISHNA INSTITUTE OF NURSING SCIENCES, KRISHNA INSTITUTE OF MEDICAL SCIENCES "DEEMED TO BE UNIVERSITY", KARAD, MALKAPUR, KARAD, DIST. SATARA, MAHARASHTRA, INDIA-415539
INDIAN
8. Whether the work is published or unpublished : UNPUBLISHED
9. Year and country of first publication and name, address and nationality of the publisher : N.A.
10. Years and countries of subsequent publications, if any, and names, addresses and nationalities of the publishers : N.A.
11. Names, addresses and nationalities of the owners of various rights comprising the copyright in the work and the extent of rights held by each, together with particulars of assignments and licences, if any : KRISHNA INSTITUTE OF MEDICAL SCIENCES "DEEMED TO BE UNIVERSITY", KARAD , KRISHNA INSTITUTE OF MEDICAL SCIENCES "DEEMED TO BE UNIVERSITY", KARAD, MALKAPUR, KARAD, DIST. SATARA, MAHARASHTRA, INDIA-415539
INDIAN
12. Names, addresses and nationalities of other persons, if any, authorised to assign or licence of rights comprising the copyright : N.A.
13. If the work is an 'Artistic work', the location of the original work, including name, address and nationality of the person in possession of the work. (In the case of an architectural work, the year of completion of the work should also be shown). : N.A.
14. If the work is an 'Artistic work' which is used or capable of being used in relation to any goods or services, the application should include a certification from the Registrar of Trade Marks in terms of the provision to Sub-Section (i) of Section 45 of the Copyright Act, 1957. : N.A.
15. If the work is an 'Artistic work', whether it is registered under the Designs Act 2000 if yes give details. : N.A.
16. If the work is an 'Artistic work', capable of being registered as a design under the Designs Act 2000, whether it has been applied to an industrial process and ,if yes ,the number of times : N.A.
17. :



21131/2019-CO/L

Date of Receipt : 31/12/2019

Date of Receipt : 31/12/2019

DEPUTY REGISTRAR OF COPYRIGHTS



Dated : 24/02/2020

1. Registration Number : **L-89701/2020**
2. Name, address and nationality of the applicant : KRISHNA INSTITUTE OF MEDICAL SCIENCES "DEEMED TO BE UNIVERSITY", KARAD , KRISHNA INSTITUTE OF MEDICAL SCIENCES "DEEMED TO BE UNIVERSITY", KARAD, MALKAPUR, KARAD, DIST. SATARA, MAHARASHTRA, INDIA-415539
INDIAN
3. Nature of the applicant's interest in the copyright of the work : OWNER
4. Class and description of the work : LITERARY/ DRAMATIC WORK
5. Title of the work : CHECKLIST ON PRACTICES TO PREVENT VARICOSE VEINS
6. Language of the work : ENGLISH
7. Name, address and nationality of the author and if the author is deceased, date of his decease : MISS. BLESSY SUSAN BABU , KRISHNA INSTITUTE OF NURSING SCIENCES, KRISHNA INSTITUTE OF MEDICAL SCIENCES "DEEMED TO BE UNIVERSITY", KARAD, MALKAPUR, KARAD, DIST. SATARA, MAHARASHTRA, INDIA-415539
INDIAN
DR. VAISHALI R.MOHITE , KRISHNA INSTITUTE OF NURSING SCIENCES, KRISHNA INSTITUTE OF MEDICAL SCIENCES "DEEMED TO BE UNIVERSITY", KARAD, MALKAPUR, KARAD, DIST. SATARA, MAHARASHTRA, INDIA-415539
INDIAN
8. Whether the work is published or unpublished : UNPUBLISHED
9. Year and country of first publication and name, address and nationality of the publisher : N.A.
10. Years and countries of subsequent publications, if any, and names, addresses and nationalities of the publishers : N.A.
11. Names, addresses and nationalities of the owners of various rights comprising the copyright in the work and the extent of rights held by each, together with particulars of assignments and licences, if any : KRISHNA INSTITUTE OF MEDICAL SCIENCES "DEEMED TO BE UNIVERSITY", KARAD , KRISHNA INSTITUTE OF MEDICAL SCIENCES "DEEMED TO BE UNIVERSITY", KARAD, MALKAPUR, KARAD, DIST. SATARA, MAHARASHTRA, INDIA-415539
INDIAN
12. Names, addresses and nationalities of other persons, if any, authorised to assign or licence of rights comprising the copyright : N.A.
13. If the work is an 'Artistic work', the location of the original work, including name, address and nationality of the person in possession of the work. (In the case of an architectural work, the year of completion of the work should also be shown). : N.A.
14. If the work is an 'Artistic work' which is used or capable of being used in relation to any goods or services, the application should include a certification from the Registrar of Trade Marks in terms of the provision to Sub-Section (i) of Section 45 of the Copyright Act, 1957. : N.A.
15. If the work is an 'Artistic work', whether it is registered under the Designs Act 2000 if yes give details. : N.A.
16. If the work is an 'Artistic work', capable of being registered as a design under the Designs Act 2000, whether it has been applied to an industrial process and ,if yes ,the number of times : N.A.
17. :



21134/2019-CO/L

Date of Receipt : 31/12/2019

Date of Receipt : 31/12/2019

DEPUTY REGISTRAR OF COPYRIGHTS



Dated : 28/02/2020

1. Registration Number : **L-89890/2020**
2. Name, address and nationality of the applicant : KRISHNA INSTITUTE OF MEDICAL SCIENCES "DEEMED TO BE UNIVERSITY", KARAD , NH4, PUNE - BANGALORE HIGHWAY, DIST.SATARA, AGASHIVNAGAR, MALKAPUR, MAHARASHTRA-415539 INDIAN
3. Nature of the applicant's interest in the copyright of the work : OWNER
4. Class and description of the work : LITERARY/ DRAMATIC WORK
5. Title of the work : THE STUDY ON ACADEMIA-INDUSTRY INTERFACE WITHIN THE GEOGRAPHICAL BOUNDARY OF 50 KM CIRCUMFERENCE FROM OUR LOCATION- SURVEY SHEET
6. Language of the work : ENGLISH
7. Name, address and nationality of the author and if the author is deceased, date of his decease : DR. PRAKASH M. SOMADE , NH4, PUNE - BANGALORE HIGHWAY, DIST.SATARA, AGASHIVNAGAR, MALKAPUR, MAHARASHTRA-415539 INDIAN
DR. SHEKHAR KUMBHAR , NH4, PUNE - BANGALORE HIGHWAY, DIST.SATARA, AGASHIVNAGAR, MALKAPUR, MAHARASHTRA-415539 INDIAN
DR. OMKAR S. KULKARNI , NH4, PUNE - BANGALORE HIGHWAY, DIST.SATARA, AGASHIVNAGAR, MALKAPUR, MAHARASHTRA-415539 INDIAN
8. Whether the work is published or unpublished : UNPUBLISHED
9. Year and country of first publication and name, address and nationality of the publisher : N.A.
10. Years and countries of subsequent publications, if any, and names, addresses and nationalities of the publishers : N.A.
11. Names, addresses and nationalities of the owners of various rights comprising the copyright in the work and the extent of rights held by each, together with particulars of assignments and licences, if any : KRISHNA INSTITUTE OF MEDICAL SCIENCES "DEEMED TO BE UNIVERSITY", KARAD , NH4, PUNE - BANGALORE HIGHWAY, DIST.SATARA, AGASHIVNAGAR, MALKAPUR, MAHARASHTRA-415539 INDIAN
12. Names, addresses and nationalities of other persons, if any, authorised to assign or licence of rights comprising the copyright : KRISHNA INSTITUTE OF MEDICAL SCIENCES "DEEMED TO BE UNIVERSITY", KARAD , NH4, PUNE - BANGALORE HIGHWAY, DIST.SATARA, AGASHIVNAGAR, MALKAPUR, MAHARASHTRA-415539 INDIAN
13. If the work is an 'Artistic work', the location of the original work, including name, address and nationality of the person in possession of the work. (In the case of an architectural work, the year of completion of the work should also be shown). : N.A.
14. If the work is an 'Artistic work' which is used or capable of being used in connection to any goods or services, the application should include information from the Registrar of Trade Marks in terms of the Section (i) of Section 45 of the Copyright Act, : N.A.
15. If the work is an 'Artistic work', whether it is registered under the Copyright Act, 1957, give details. : N.A.
16. If the work is an 'Artistic work', capable of being registered as a design under the Designs Act 2000, whether it has been applied to an article, or to an industrial process and, if yes, the number of times it is registered. : N.A.
17. Remarks, if any :



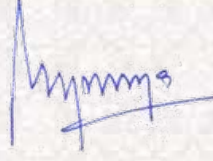

DEPUTY REGISTRAR OF COPYRIGHTS

Diary Number : 20836/2019-CO/L
Date of Application : 27/12/2019
Date of Receipt : 27/12/2019



Dated : 28/02/2020

1. Registration Number : **L-89889/2020**
2. Name, address and nationality of the applicant : KRISHNA INSTITUTE OF MEDICAL SCIENCES "DEEMED TO BE UNIVERSITY", KARAD , NH4, PUNE - BANGALORE HIGHWAY, DIST.SATARA, AGASHIVNAGAR, MALKAPUR, MAHARASHTRA-415539 INDIAN
3. Nature of the applicant's interest in the copyright of the work : OWNER
4. Class and description of the work : LITERARY/ DRAMATIC WORK
5. Title of the work : RELEVANCE OF BIOETHICAL PRINCIPLES IN PHYSIOTHERAPY PRACTICE BIOETHICS IN HEALTH CARE
6. Language of the work : ENGLISH
7. Name, address and nationality of the author and if the author is deceased, date of his decease : DR. T. POOVISHNU DEVI , KRISHNA INSTITUTE OF MEDICAL SCIENCES "DEEMED TO BE UNIVERSITY", KARAD-415539 INDIAN
8. Whether the work is published or unpublished : UNPUBLISHED
9. Year and country of first publication and name, address and nationality of the publisher : N.A.
10. Years and countries of subsequent publications, if any, and names, addresses and nationalities of the publishers : N.A.
11. Names, addresses and nationalities of the owners of various rights comprising the copyright in the work and the extent of rights held by each, together with particulars of assignments and licences, if any : KRISHNA INSTITUTE OF MEDICAL SCIENCES "DEEMED TO BE UNIVERSITY", KARAD , NH4, PUNE - BANGALORE HIGHWAY, DIST.SATARA, AGASHIVNAGAR, MALKAPUR, MAHARASHTRA-415539 INDIAN
12. Names, addresses and nationalities of other persons, if any, authorised to assign or licence of rights comprising the copyright : KRISHNA INSTITUTE OF MEDICAL SCIENCES "DEEMED TO BE UNIVERSITY", KARAD , NH4, PUNE - BANGALORE HIGHWAY, DIST.SATARA, AGASHIVNAGAR, MALKAPUR, MAHARASHTRA-415539 INDIAN
13. If the work is an 'Artistic work', the location of the original work, including name, address and nationality of the person in possession of the work. (In the case of an architectural work, the year of completion of the work should also be shown). : N.A.
14. If the work is an 'Artistic work' which is used or capable of being used in relation to any goods or services, the application should include a certification from the Registrar of Trade Marks in terms of the provision to Sub-Section (i) of Section 45 of the Copyright Act, 1957. : N.A.
15. If the work is an 'Artistic work', whether it is registered under the Designs Act 2000 if yes give details. : N.A.
16. If the work is an 'Artistic work', capable of being registered as a design under the Designs Act 2000.whether it has been applied to an article though an industrial process and ,if yes ,the number of times it is reproduced. : N.A.
17. Re : N.A.



20830/2019-CO/L
27/12/2019
27/12/2019

DEPUTY REGISTRAR OF COPYRIGHTS



Dated : 28/02/2020

1. Registration Number : **L-89891/2020**
2. Name, address and nationality of the applicant : KRISHNA INSTITUTE OF MEDICAL SCIENCES "DEEMED TO BE UNIVERSITY", KARAD , NH4, PUNE - BANGALORE HIGHWAY, DIST.SATARA, AGASHIVNAGAR, MALKAPUR, MAHARASHTRA-415539 INDIAN
3. Nature of the applicant's interest in the copyright of the work : OWNER
4. Class and description of the work : LITERARY/ DRAMATIC WORK
5. Title of the work : DEMONSTRATION OF INCISION AND LACERATION USING OBJECT-PAPER
6. Language of the work : ENGLISH
7. Name, address and nationality of the author and if the author is deceased, date of his decease : DR. CHANDRAKANT M KOKATANUR , NH4, PUNE - BANGALORE HIGHWAY, DIST.SATARA, AGASHIVNAGAR, MALKAPUR, MAHARASHTRA-415539 INDIAN
8. Whether the work is published or unpublished : UNPUBLISHED
9. Year and country of first publication and name, address and nationality of the publisher : N.A.
10. Years and countries of subsequent publications, if any, and names, addresses and nationalities of the publishers : N.A.
11. Names, addresses and nationalities of the owners of various rights comprising the copyright in the work and the extent of rights held by each, together with particulars of assignments and licences, if any : KRISHNA INSTITUTE OF MEDICAL SCIENCES "DEEMED TO BE UNIVERSITY", KARAD , NH4, PUNE - BANGALORE HIGHWAY, DIST.SATARA, AGASHIVNAGAR, MALKAPUR, MAHARASHTRA-415539 INDIAN
12. Names, addresses and nationalities of other persons, if any, authorised to assign or licence of rights comprising the copyright : KRISHNA INSTITUTE OF MEDICAL SCIENCES "DEEMED TO BE UNIVERSITY", KARAD , NH4, PUNE - BANGALORE HIGHWAY, DIST.SATARA, AGASHIVNAGAR, MALKAPUR, MAHARASHTRA-415539 INDIAN
13. If the work is an 'Artistic work', the location of the original work, including name, address and nationality of the person in possession of the work. (In the case of an architectural work, the year of completion of the work should also be shown). : N.A.
14. If the work is an 'Artistic work' which is used or capable of being used in relation to any goods or services, the application should include a certification from the Registrar of Trade Marks in terms of the provision to Sub-Section (i) of Section 45 of the Copyright Act, 1957. : N.A.
15. If the work is an 'Artistic work', whether it is registered under the Designs Act 2000 if yes give details. : N.A.
16. If the work is an 'Artistic work', capable of being registered as a design under the Designs Act 2000.whether it has been applied to an article though an industrial process and ,if yes ,the number of times it is reproduced. : N.A.
17. Remarks, if any :

Diary No. 20839/2019-CO/L
Date 27/12/2019
27/12/2019



DEPUTY REGISTRAR OF COPYRIGHTS



Dated : 28/02/2020

1. Registration Number : **L-89949/2020**
 2. Name, address and nationality of the applicant : KRISHNA INSTITUTE OF MEDICAL SCIENCES "DEEMED TO BE UNIVERSITY", KARAD , NH4, PUNE - BANGALORE HIGHWAY, DIST.SATARA, AGASHIVNAGAR, MALKAPUR, MAHARASHTRA-415539 INDIAN
 3. Nature of the applicant's interest in the copyright of the work : OWNER
 4. Class and description of the work : LITERARY/ DRAMATIC WORK
 5. Title of the work : TOOL FOR ASSESSMENT OF BREAST, NIPPLE AND SUCCESSFUL BREAST FEEDING
 6. Language of the work : ENGLISH
 7. Name, address and nationality of the author and if the author is deceased, date of his decease : DR. JYOTI A. SALUNKHE , KRISHNA INSTITUTE OF MEDICAL SCIENCES "DEEMED TO BE UNIVERSITY", KARAD-415539 INDIAN
DR. AVINASH H. SALUNKHE , KRISHNA INSTITUTE OF MEDICAL SCIENCES "DEEMED TO BE UNIVERSITY", KARAD-415539 INDIAN
DR. S.V.KAKADE , KRISHNA INSTITUTE OF MEDICAL SCIENCES "DEEMED TO BE UNIVERSITY", KARAD-415539 INDIAN
 8. Whether the work is published or unpublished : UNPUBLISHED
 9. Year and country of first publication and name, address and nationality of the publisher : N.A.
 10. Years and countries of subsequent publications, if any, and names, addresses and nationalities of the publishers : N.A.
 11. Names, addresses and nationalities of the owners of various rights comprising the copyright in the work and the extent of rights held by each, together with particulars of assignments and licences, if any : KRISHNA INSTITUTE OF MEDICAL SCIENCES "DEEMED TO BE UNIVERSITY", KARAD , NH4, PUNE - BANGALORE HIGHWAY, DIST.SATARA, AGASHIVNAGAR, MALKAPUR, MAHARASHTRA-415539 INDIAN
 12. Names, addresses and nationalities of other persons, if any, authorised to assign or licence of rights comprising the copyright : KRISHNA INSTITUTE OF MEDICAL SCIENCES "DEEMED TO BE UNIVERSITY", KARAD , NH4, PUNE - BANGALORE HIGHWAY, DIST.SATARA, AGASHIVNAGAR, MALKAPUR, MAHARASHTRA-415539 INDIAN
 13. If the work is an 'Artistic work', the location of the original work, including name, address and nationality of the person in possession of the work. (In the case of an architectural work, the year of completion of the work should also be shown). : N.A.
 14. If the work is an 'Artistic work' which is used or capable of being used in relation to any goods or services, the application should include a certification from the Registrar of Trade Marks in terms of the provision to Sub-Section (i) of Section 45 of the Copyright Act, 1957. : N.A.
 15. If the work is an 'Artistic work', whether it is registered under the Copyright Act, 1957, give details. : N.A.
 16. If the work is an 'Artistic work', capable of being registered as a trademark under the Trade Marks Act 2000, whether it has been applied to an article, the date of application, the date of registration, the date of renewal, the date of cancellation, if any, and the date of revival, if any, and the number of times the work has been registered. : N.A.
 17. Registrar : 
DEPUTY REGISTRAR OF COPYRIGHTS
- Diary Number : 20798/2019-CO/L
Date of Application : 26/12/2019
Date of Receipt : 26/12/2019





Dated : 05/03/2020

1. Registration Number : **L-90149/2020**
 2. Name, address and nationality of the applicant : KRISHNA INSTITUTE OF MEDICAL SCIENCES "DEEMED TO BE UNIVERSITY", KARAD , KRISHNA INSTITUTE OF MEDICAL SCIENCES "DEEMED TO BE UNIVERSITY", KARAD, MALKAPUR, KARAD, DIST. SATARA, MAHARASHTRA, INDIA-415539
INDIAN
 3. Nature of the applicant's interest in the copyright of the work : OWNER
 4. Class and description of the work : LITERARY/ DRAMATIC WORK
 5. Title of the work : VIJAYPATH- MARG VYASANMUKTICHA
 6. Language of the work : MARATHI
 7. Name, address and nationality of the author and if the author is deceased, date of his decease : DR. AJISH GOPINATH MANGOT , ASSOCIATE PROFESSOR, DEPARTMENT OF PSYCHIATRY, KRISHNA INSTITUTE OF MEDICAL SCIENCES "DEEMED TO BE UNIVERSITY", KARAD-415539
INDIAN

DR. VASANTMEGHA SRINIVASA MURTHY , ASSOCIATE PROFESSOR, DEPARTMENT OF PSYCHIATRY, KRISHNA INSTITUTE OF MEDICAL SCIENCES "DEEMED TO BE UNIVERSITY", KARAD-415539
INDIAN

MRS. SHUBHANGI NITIN JAMALE , PSYCHOLOGIST, DEPARTMENT OF PSYCHIATRY, KRISHNA INSTITUTE OF MEDICAL SCIENCES "DEEMED TO BE UNIVERSITY", KARAD-415539
INDIAN
 8. Whether the work is published or unpublished : UNPUBLISHED
 9. Year and country of first publication and name, address and nationality of the publisher : N.A.
 10. Years and countries of subsequent publications, if any, and names, addresses and nationalities of the publishers : N.A.
 11. Names, addresses and nationalities of the owners of various rights comprising the copyright in the work and the extent of rights held by each, together with particulars of assignments and licences, if any : KRISHNA INSTITUTE OF MEDICAL SCIENCES "DEEMED TO BE UNIVERSITY", KARAD , KRISHNA INSTITUTE OF MEDICAL SCIENCES "DEEMED TO BE UNIVERSITY", KARAD, MALKAPUR, KARAD, DIST. SATARA, MAHARASHTRA, INDIA-415539
INDIAN
 12. Names, addresses and nationalities of other persons, if any, authorised to assign or licence of rights comprising the copyright : N.A.
 13. If the work is an 'Artistic work', the location of the original work, including name, address and nationality of the person in possession of the work. (In the case of an architectural work, the year of completion of the work should also be shown). : N.A.
 14. If the work is an 'Artistic work' which is used or capable of being used in relation to any goods or services, the application should include a certification from the Registrar of Trade Marks in terms of the provision to Sub-Section (i) of Section 45 of the Copyright Act, 1957. : N.A.
 15. If the work is an 'Artistic work', whether it is registered under the Copyright Act, 1957, give details. : N.A.
 16. If the work is an 'Artistic work', capable of being registered as a work under the Copyright Act 2000, whether it has been applied to an artistic process and, if yes, the number of times : N.A.
 17. Registrar : 
DEPUTY REGISTRAR OF COPYRIGHTS
- Diary Number : 24/2020-CO/L
Date of Application : 01/01/2020
Date of Receipt : 01/01/2020





Dated : 24/02/2020

1. Registration Number : **L-89753/2020**
2. Name, address and nationality of the applicant : KRISHNA INSTITUTE OF MEDICAL SCIENCES "DEEMED TO BE UNIVERSITY", KARAD , KRISHNA INSTITUTE OF MEDICAL SCIENCES "DEEMED TO BE UNIVERSITY", KARAD, MALKAPUR, KARAD, DIST. SATARA, MAHARASHTRA, INDIA-415539 INDIAN
3. Nature of the applicant's interest in the copyright of the work : OWNER
4. Class and description of the work : LITERARY/ DRAMATIC WORK
5. Title of the work : DEVELOPING A MODIFIED JOHN HOPKINS BLOOMBERG SCHOOL OF PUBLIC HEALTH TOOL FOR ASSESSING BIRTH PREPAREDNESS AND COMPLICATION READINESS AMONG ANTENATAL AND POSTNATAL WOMEN
6. Language of the work : ENGLISH
7. Name, address and nationality of the author and if the author is deceased, date of his decease : DR. VIYUSHA T. VISWANATHAN , DEPARTMENT OF COMMUNITY MEDICINE, KRISHNA INSTITUTE OF MEDICAL SCIENCES "DEEMED TO BE UNIVERSITY", KARAD, MALKAPUR, KARAD, DIST. SATARA, MAHARASHTRA, INDIA-415539 INDIAN
DR. SUPRIYA S. PATIL , DEPARTMENT OF COMMUNITY MEDICINE, KRISHNA INSTITUTE OF MEDICAL SCIENCES "DEEMED TO BE UNIVERSITY", KARAD, MALKAPUR, KARAD, DIST. SATARA, MAHARASHTRA, INDIA-415539 INDIAN
8. Whether the work is published or unpublished : UNPUBLISHED
9. Year and country of first publication and name, address and nationality of the publisher : N.A.
10. Years and countries of subsequent publications, if any, and names, addresses and nationalities of the publishers : N.A.
11. Names, addresses and nationalities of the owners of various rights comprising the copyright in the work and the extent of rights held by each, together with particulars of assignments and licences, if any : KRISHNA INSTITUTE OF MEDICAL SCIENCES "DEEMED TO BE UNIVERSITY", KARAD , KRISHNA INSTITUTE OF MEDICAL SCIENCES "DEEMED TO BE UNIVERSITY", KARAD, MALKAPUR, KARAD, DIST. SATARA, MAHARASHTRA, INDIA-415539 INDIAN
12. Names, addresses and nationalities of other persons, if any, authorised to assign or licence of rights comprising the copyright : N.A.
13. If the work is an 'Artistic work', the location of the original work, including name, address and nationality of the person in possession of the work. (In the case of an architectural work, the year of completion of the work should also be shown). : N.A.
14. If the work is an 'Artistic work' which is used or capable of being used in relation to any goods or services, the application should include a certification from the Registrar of Trade Marks in terms of the provision to Sub-Section (i) of Section 45 of the Copyright Act, 1957. : N.A.
15. If the work is an 'Artistic work', whether it is registered under the Designs Act, 2000 if yes give details. : N.A.
16. If the work is an 'Artistic work', capable of being registered as a design under the Designs Act 2000, whether it has been applied to an article, the date of application, the date of registration, the date of the design process and ,if yes ,the number of times : N.A.
17. :





Registration Number : 38/2020-CO/L
Date of Application : 01/01/2020
Date of Receipt : 01/01/2020

DEPUTY REGISTRAR OF COPYRIGHTS



Dated : 29/04/2020

1. Registration Number : **L-90738/2020**
2. Name, address and nationality of the applicant : KRISHNA INSTITUTE OF MEDICAL SCIENCES "DEEMED TO BE UNIVERSITY", KARAD , NH4, PUNE - BANGALORE HIGHWAY, DIST.SATARA, AGASHIVNAGAR, MALKAPUR, MAHARASHTRA-415539 INDIAN
3. Nature of the applicant's interest in the copyright of the work : OWNER
4. Class and description of the work : LITERARY/ DRAMATIC WORK
5. Title of the work : AN ODE ON LICHEN PLANUS
6. Language of the work : ENGLISH
7. Name, address and nationality of the author and if the author is deceased, date of his decease : DR. UZMA IQBAL BELGAUMI , NH4, PUNE - BANGALORE HIGHWAY, DIST.SATARA, AGASHIVNAGAR, MALKAPUR, MAHARASHTRA-415539 INDIAN
8. Whether the work is published or unpublished : UNPUBLISHED
9. Year and country of first publication and name, address and nationality of the publisher : N.A.
10. Years and countries of subsequent publications, if any, and names, addresses and nationalities of the publishers : N.A.
11. Names, addresses and nationalities of the owners of various rights comprising the copyright in the work and the extent of rights held by each, together with particulars of assignments and licences, if any : KRISHNA INSTITUTE OF MEDICAL SCIENCES "DEEMED TO BE UNIVERSITY", KARAD , NH4, PUNE - BANGALORE HIGHWAY, DIST.SATARA, AGASHIVNAGAR, MALKAPUR, MAHARASHTRA-415539 INDIAN
12. Names, addresses and nationalities of other persons, if any, authorised to assign or licence of rights comprising the copyright : KRISHNA INSTITUTE OF MEDICAL SCIENCES "DEEMED TO BE UNIVERSITY", KARAD , NH4, PUNE - BANGALORE HIGHWAY, DIST.SATARA, AGASHIVNAGAR, MALKAPUR, MAHARASHTRA-415539 INDIAN
13. If the work is an 'Artistic work', the location of the original work, including name, address and nationality of the person in possession of the work. (In the case of an architectural work, the year of completion of the work should also be shown). : N.A.
14. If the work is an 'Artistic work' which is used or capable of being used in relation to any goods or services, the application should include a certification from the Registrar of Trade Marks in terms of the provision to Sub-Section (i) of Section 45 of the Copyright Act, 1957. : N.A.
15. If the work is an 'Artistic work', whether it is registered under the Designs Act 2000 if yes give details. : N.A.
16. If the work is an 'Artistic work', capable of being registered as a design under the Designs Act 2000.whether it has been applied to an article though an industrial process and ,if yes ,the number of times it is reproduced. : N.A.
17. Remarks, if any :

Diary Number : 3281/2020-CO/L

Date : 20/02/2020

20/02/2020



DEPUTY REGISTRAR OF COPYRIGHTS



Dated : 29/04/2020

1. Registration Number : **L-90757/2020**
2. Name, address and nationality of the applicant : KRISHNA INSTITUTE OF MEDICAL SCIENCES "DEEMED TO BE UNIVERSITY", KARAD , NH4, PUNE - BANGALORE HIGHWAY, DIST.SATARA, AGASHIVNAGAR, MALKAPUR, MAHARASHTRA-415539 INDIAN
3. Nature of the applicant's interest in the copyright of the work : OWNER
4. Class and description of the work : LITERARY/ DRAMATIC WORK
5. Title of the work : TOLUIDINE BLUE AS A NEW, SIMPLE AND COST EFFECTIVE LABORATORY STAIN FOR STAINING ORAL EXFOLIATIVE CYTOLOGY SMEARS IN COMPARISON WITH STANDARD STAINING PROCEDURE
6. Language of the work : ENGLISH
7. Name, address and nationality of the author and if the author is deceased, date of his decease : DR UZMA I BELGAUMI , NH4, PUNE - BANGALORE HIGHWAY, DIST.SATARA, AGASHIVNAGAR, MALKAPUR, MAHARASHTRA-415539 INDIAN
MS SHWETA JHA , NH4, PUNE - BANGALORE HIGHWAY, DIST.SATARA, AGASHIVNAGAR, MALKAPUR, MAHARASHTRA-415539 INDIAN
8. Whether the work is published or unpublished : UNPUBLISHED
9. Year and country of first publication and name, address and nationality of the publisher : N.A.
10. Years and countries of subsequent publications, if any, and names, addresses and nationalities of the publishers : N.A.
11. Names, addresses and nationalities of the owners of various rights comprising the copyright in the work and the extent of rights held by each, together with particulars of assignments and licences, if any : KRISHNA INSTITUTE OF MEDICAL SCIENCES "DEEMED TO BE UNIVERSITY", KARAD , NH4, PUNE - BANGALORE HIGHWAY, DIST.SATARA, AGASHIVNAGAR, MALKAPUR, MAHARASHTRA-415539 INDIAN
12. Names, addresses and nationalities of other persons, if any, authorised to assign or licence of rights comprising the copyright : KRISHNA INSTITUTE OF MEDICAL SCIENCES "DEEMED TO BE UNIVERSITY", KARAD , NH4, PUNE - BANGALORE HIGHWAY, DIST.SATARA, AGASHIVNAGAR, MALKAPUR, MAHARASHTRA-415539 INDIAN
13. If the work is an 'Artistic work', the location of the original work, including name, address and nationality of the person in possession of the work. (In the case of an architectural work, the year of completion of the work should also be shown). : N.A.
14. If the work is an 'Artistic work' which is used or capable of being used in relation to any goods or services, the application should include a certification from the Registrar of Trade Marks in terms of the provision to Sub-Section (i) of Section 45 of the Copyright Act, 1957. : N.A.
15. If the work is an 'Artistic work', whether it is registered under the Designs Act 2000 if yes give details. : N.A.
16. If the work is an 'Artistic work', capable of being registered as a design under the Designs Act 2000, whether it has been applied to an article, if yes, the number of times : N.A.

17. :
3297/2020-CO/L
20/02/2020
Date of registration : 20/02/2020



DEPUTY REGISTRAR OF COPYRIGHTS



Dated : 29/04/2020

1. Registration Number : **L-90735/2020**
 2. Name, address and nationality of the applicant : KRISHNA INSTITUTE OF MEDICAL SCIENCES "DEEMED TO BE UNIVERSITY", KARAD , NH4, PUNE - BANGALORE HIGHWAY, DIST.SATARA, AGASHIVNAGAR, MALKAPUR, MAHARASHTRA-415539
INDIAN
 3. Nature of the applicant's interest in the copyright of the work : OWNER
 4. Class and description of the work : LITERARY/ DRAMATIC WORK
 5. Title of the work : RESTORING OCCLUSAL ANATOMY AND FUNCTION IN IMPLANT RETAINED FIXED PROSTHESIS WITH OCCLUSAL MARKER
 6. Language of the work : ENGLISH
 7. Name, address and nationality of the author and if the author is deceased, date of his decease : DR. SHIVSAGAR TEWARY , NH4, PUNE - BANGALORE HIGHWAY, DIST.SATARA, AGASHIVNAGAR, MALKAPUR, MAHARASHTRA-415539
INDIAN

DR. KARUNA PAWASHE , NH4, PUNE - BANGALORE HIGHWAY, DIST.SATARA, AGASHIVNAGAR, MALKAPUR, MAHARASHTRA-415539
INDIAN

DR. PRONOB SANYAL , NH4, PUNE - BANGALORE HIGHWAY, DIST.SATARA, AGASHIVNAGAR, MALKAPUR, MAHARASHTRA-415539
INDIAN
 8. Whether the work is published or unpublished : UNPUBLISHED
 9. Year and country of first publication and name, address and nationality of the publisher : N.A.
 10. Years and countries of subsequent publications, if any, and names, addresses and nationalities of the publishers : N.A.
 11. Names, addresses and nationalities of the owners of various rights comprising the copyright in the work and the extent of rights held by each, together with particulars of assignments and licences, if any : KRISHNA INSTITUTE OF MEDICAL SCIENCES "DEEMED TO BE UNIVERSITY", KARAD , NH4, PUNE - BANGALORE HIGHWAY, DIST.SATARA, AGASHIVNAGAR, MALKAPUR, MAHARASHTRA-415539
INDIAN
 12. Names, addresses and nationalities of other persons, if any, authorised to assign or licence of rights comprising the copyright : KRISHNA INSTITUTE OF MEDICAL SCIENCES "DEEMED TO BE UNIVERSITY", KARAD , NH4, PUNE - BANGALORE HIGHWAY, DIST.SATARA, AGASHIVNAGAR, MALKAPUR, MAHARASHTRA-415539
INDIAN
 13. If the work is an 'Artistic work', the location of the original work, including name, address and nationality of the person in possession of the work. (In the case of an architectural work, the year of completion of the work should also be shown). : N.A.
 14. If the work is an 'Artistic work' which is used or capable of being used in relation to any goods or services, the application should include a certification from the Registrar of Trade Marks in terms of the provision to Sub-Section (i) of Section 45 of the Copyright Act, 1957. : N.A.
 15. If the work is an 'Artistic work', whether it is registered under the Copyright Act, 1957, give details. : N.A.
 16. If the work is an 'Artistic work', capable of being registered as a trademark under the Trademarks Act 2000, whether it has been applied to an article, the date of application, the date of registration, if any, the date of the registration process and, if yes, the number of times : N.A.
 17. : N.A.
- Diary : 3276/2020-CO/L
- Date of Application : 20/02/2020
- Date of Receipt : 20/02/2020
- 
DEPUTY REGISTRAR OF COPYRIGHTS





Dated : 29/04/2020

1. Registration Number : **L-90734/2020**
2. Name, address and nationality of the applicant : KRISHNA INSTITUTE OF MEDICAL SCIENCES "DEEMED TO BE UNIVERSITY", KARAD , NH4, PUNE - BANGALORE HIGHWAY, DIST.SATARA, AGASHIVNAGAR, MALKAPUR, MAHARASHTRA-415539 INDIAN
3. Nature of the applicant's interest in the copyright of the work : OWNER
4. Class and description of the work : LITERARY/ DRAMATIC WORK
5. Title of the work : MODIFIED POSITIONAL RELEASE TECHNIQUE
6. Language of the work : ENGLISH
7. Name, address and nationality of the author and if the author is deceased, date of his decease : DR.PRASANNAJEET PRAMOD NIKAM , NH4, PUNE - BANGALORE HIGHWAY, DIST.SATARA, AGASHIVNAGAR, MALKAPUR, MAHARASHTRA-415539 INDIAN
8. Whether the work is published or unpublished : UNPUBLISHED
9. Year and country of first publication and name, address and nationality of the publisher : N.A.
10. Years and countries of subsequent publications, if any, and names, addresses and nationalities of the publishers : N.A.
11. Names, addresses and nationalities of the owners of various rights comprising the copyright in the work and the extent of rights held by each, together with particulars of assignments and licences, if any : KRISHNA INSTITUTE OF MEDICAL SCIENCES "DEEMED TO BE UNIVERSITY", KARAD , NH4, PUNE - BANGALORE HIGHWAY, DIST.SATARA, AGASHIVNAGAR, MALKAPUR, MAHARASHTRA-415539 INDIAN
12. Names, addresses and nationalities of other persons, if any, authorised to assign or licence of rights comprising the copyright : KRISHNA INSTITUTE OF MEDICAL SCIENCES "DEEMED TO BE UNIVERSITY", KARAD , NH4, PUNE - BANGALORE HIGHWAY, DIST.SATARA, AGASHIVNAGAR, MALKAPUR, MAHARASHTRA-415539 INDIAN
13. If the work is an 'Artistic work', the location of the original work, including name, address and nationality of the person in possession of the work. (In the case of an architectural work, the year of completion of the work should also be shown). : N.A.
14. If the work is an 'Artistic work' which is used or capable of being used in relation to any goods or services, the application should include a certification from the Registrar of Trade Marks in terms of the provision to Sub-Section (i) of Section 45 of the Copyright Act, 1957. : N.A.
15. If the work is an 'Artistic work', whether it is registered under the Designs Act 2000 if yes give details. : N.A.
16. If the work is an 'Artistic work', capable of being registered as a design under the Designs Act 2000.whether it has been applied to an article though an industrial process and ,if yes ,the number of times it is reproduced. : N.A.
17. Remarks, if any :

Diary Number : 3270/2020-CO/L

Date : 20/02/2020

20/02/2020



DEPUTY REGISTRAR OF COPYRIGHTS



Dated : 29/04/2020

1. Registration Number : **L-90732/2020**
2. Name, address and nationality of the applicant : KRISHNA INSTITUTE OF MEDICAL SCIENCES "DEEMED TO BE UNIVERSITY", KARAD , NH4, PUNE - BANGALORE HIGHWAY, DIST.SATARA, AGASHIVNAGAR, MALKAPUR, MAHARASHTRA-415539 INDIAN
3. Nature of the applicant's interest in the copyright of the work : OWNER
4. Class and description of the work : LITERARY/ DRAMATIC WORK
5. Title of the work : DEMONSTRATION OF ABRASION USING BANANA STEM
6. Language of the work : ENGLISH
7. Name, address and nationality of the author and if the author is deceased, date of his decease : DR. CHANDRAKANT M KOKATANUR , NH4, PUNE - BANGALORE HIGHWAY, DIST.SATARA, AGASHIVNAGAR, MALKAPUR, MAHARASHTRA-415539 INDIAN
8. Whether the work is published or unpublished : UNPUBLISHED
9. Year and country of first publication and name, address and nationality of the publisher : N.A.
10. Years and countries of subsequent publications, if any, and names, addresses and nationalities of the publishers : N.A.
11. Names, addresses and nationalities of the owners of various rights comprising the copyright in the work and the extent of rights held by each, together with particulars of assignments and licences, if any : KRISHNA INSTITUTE OF MEDICAL SCIENCES "DEEMED TO BE UNIVERSITY", KARAD , NH4, PUNE - BANGALORE HIGHWAY, DIST.SATARA, AGASHIVNAGAR, MALKAPUR, MAHARASHTRA-415539 INDIAN
12. Names, addresses and nationalities of other persons, if any, authorised to assign or licence of rights comprising the copyright : KRISHNA INSTITUTE OF MEDICAL SCIENCES "DEEMED TO BE UNIVERSITY", KARAD , NH4, PUNE - BANGALORE HIGHWAY, DIST.SATARA, AGASHIVNAGAR, MALKAPUR, MAHARASHTRA-415539 INDIAN
13. If the work is an 'Artistic work', the location of the original work, including name, address and nationality of the person in possession of the work. (In the case of an architectural work, the year of completion of the work should also be shown). : N.A.
14. If the work is an 'Artistic work' which is used or capable of being used in relation to any goods or services, the application should include a certification from the Registrar of Trade Marks in terms of the provision to Sub-Section (i) of Section 45 of the Copyright Act, 1957. : N.A.
15. If the work is an 'Artistic work', whether it is registered under the Designs Act 2000 if yes give details. : N.A.
16. If the work is an 'Artistic work', capable of being registered as a design under the Designs Act 2000.whether it has been applied to an article though an industrial process and ,if yes ,the number of times it is reproduced. : N.A.
17. Remarks, if any :

Diary Number : 3267/2020-CO/L

Date : 20/02/2020

20/02/2020



DEPUTY REGISTRAR OF COPYRIGHTS



Dated : 29/04/2020

1. Registration Number : **L-90731/2020**
2. Name, address and nationality of the applicant : KRISHNA INSTITUTE OF MEDICAL SCIENCES "DEEMED TO BE UNIVERSITY", KARAD , NH4, PUNE - BANGALORE HIGHWAY, DIST.SATARA, AGASHIVNAGAR, MALKAPUR, MAHARASHTRA-415539 INDIAN
3. Nature of the applicant's interest in the copyright of the work : OWNER
4. Class and description of the work : LITERARY/ DRAMATIC WORK
5. Title of the work : DEMONSTRATION OF INCISION AND LACERATION USING OBJECT - PAPER
6. Language of the work : ENGLISH
7. Name, address and nationality of the author and if the author is deceased, date of his decease : DR. CHANDRAKANT M KOKATANUR , NH4, PUNE - BANGALORE HIGHWAY, DIST.SATARA, AGASHIVNAGAR, MALKAPUR, MAHARASHTRA-415539 INDIAN
8. Whether the work is published or unpublished : UNPUBLISHED
9. Year and country of first publication and name, address and nationality of the publisher : N.A.
10. Years and countries of subsequent publications, if any, and names, addresses and nationalities of the publishers : N.A.
11. Names, addresses and nationalities of the owners of various rights comprising the copyright in the work and the extent of rights held by each, together with particulars of assignments and licences, if any : KRISHNA INSTITUTE OF MEDICAL SCIENCES "DEEMED TO BE UNIVERSITY", KARAD , NH4, PUNE - BANGALORE HIGHWAY, DIST.SATARA, AGASHIVNAGAR, MALKAPUR, MAHARASHTRA-415539 INDIAN
12. Names, addresses and nationalities of other persons, if any, authorised to assign or licence of rights comprising the copyright : KRISHNA INSTITUTE OF MEDICAL SCIENCES "DEEMED TO BE UNIVERSITY", KARAD , NH4, PUNE - BANGALORE HIGHWAY, DIST.SATARA, AGASHIVNAGAR, MALKAPUR, MAHARASHTRA-415539 INDIAN
13. If the work is an 'Artistic work', the location of the original work, including name, address and nationality of the person in possession of the work. (In the case of an architectural work, the year of completion of the work should also be shown). : N.A.
14. If the work is an 'Artistic work' which is used or capable of being used in relation to any goods or services, the application should include a certification from the Registrar of Trade Marks in terms of the provision to Sub-Section (i) of Section 45 of the Copyright Act, 1957. : N.A.
15. If the work is an 'Artistic work', whether it is registered under the Designs Act 2000 if yes give details. : N.A.
16. If the work is an 'Artistic work', capable of being registered as a design under the Designs Act 2000.whether it has been applied to an article though an industrial process and ,if yes ,the number of times it is reproduced. : N.A.
17. Remarks, if any :

Diary No. 3264/2020-CO/L
Date 20/02/2020
20/02/2020



DEPUTY REGISTRAR OF COPYRIGHTS



Dated : 04/05/2020

- | | | |
|--|---|---|
| 1. Registration Number | : | L-91088/2020 |
| 2. Name, address and nationality of the applicant | : | KRISHNA INSTITUTE OF MEDICAL SCIENCES "DEEMED TO BE UNIVERSITY", KARAD , NH4, PUNE - BANGALORE HIGHWAY, DIST.SATARA, AGASHIVNAGAR, MALKAPUR, MAHARASHTRA-415539
INDIAN |
| 3. Nature of the applicant's interest in the copyright of the work | : | OWNER |
| 4. Class and description of the work | : | LITERARY/ DRAMATIC WORK |
| 5. Title of the work | : | DEMONSTRATION OF INCISION STAB WOUND AND LACERATION USING OBJECT : BANANA STEM |
| 6. Language of the work | : | ENGLISH |
| 7. Name, address and nationality of the author and if the author is deceased, date of his decease | : | DR. CHANDRAKANT M KOKATANUR , NH4, PUNE - BANGALORE HIGHWAY, DIST.SATARA, AGASHIVNAGAR, MALKAPUR, MAHARASHTRA-415539
INDIAN |
| 8. Whether the work is published or unpublished | : | UNPUBLISHED |
| 9. Year and country of first publication and name, address and nationality of the publisher | : | N.A. |
| 10. Years and countries of subsequent publications, if any, and names, addresses and nationalities of the publishers | : | N.A. |
| 11. Names, addresses and nationalities of the owners of various rights comprising the copyright in the work and the extent of rights held by each, together with particulars of assignments and licences, if any | : | KRISHNA INSTITUTE OF MEDICAL SCIENCES "DEEMED TO BE UNIVERSITY", KARAD , NH4, PUNE - BANGALORE HIGHWAY, DIST.SATARA, AGASHIVNAGAR, MALKAPUR, MAHARASHTRA-415539
INDIAN |
| 12. Names, addresses and nationalities of other persons, if any, authorised to assign or licence of rights comprising the copyright | : | KRISHNA INSTITUTE OF MEDICAL SCIENCES "DEEMED TO BE UNIVERSITY", KARAD , NH4, PUNE - BANGALORE HIGHWAY, DIST.SATARA, AGASHIVNAGAR, MALKAPUR, MAHARASHTRA-415539
INDIAN |
| 13. If the work is an 'Artistic work', the location of the original work, including name, address and nationality of the person in possession of the work. (In the case of an architectural work, the year of completion of the work should also be shown). | : | N.A. |
| 14. If the work is an 'Artistic work' which is used or capable of being used in relation to any goods or services, the application should include a certification from the Registrar of Trade Marks in terms of the provision to Sub-Section (i) of Section 45 of the Copyright Act, 1957. | : | N.A. |
| 15. If the work is an 'Artistic work', whether it is registered under the Designs Act 2000 if yes give details. | : | N.A. |
| 16. If the work is an 'Artistic work', capable of being registered as a design under the Designs Act 2000.whether it has been applied to an article though an industrial process and ,if yes ,the number of times it is reproduced. | : | N.A. |
| 17. Remarks, if any | : | |

Diary No. 3239/2020-CO/L
Date 19/02/2020
19/02/2020



DEPUTY REGISTRAR OF COPYRIGHTS



Dated : 04/05/2020

1. Registration Number : **L-91090/2020**
2. Name, address and nationality of the applicant : KRISHNA INSTITUTE OF MEDICAL SCIENCES "DEEMED TO BE UNIVERSITY", KARAD , NH4, PUNE - BANGALORE HIGHWAY, DIST.SATARA, AGASHIVNAGAR, MALKAPUR, MAHARASHTRA-415539 INDIAN
3. Nature of the applicant's interest in the copyright of the work : OWNER
4. Class and description of the work : LITERARY/ DRAMATIC WORK
5. Title of the work : STUDENT LEARNING BY PERFORMING (UNDER SUPERVISION) DEMONSTRATION OF INCISION, STAB AND LACERATION USING BALSAM STEM
6. Language of the work : ENGLISH
7. Name, address and nationality of the author and if the author is deceased, date of his decease : DR. CHANDRAKANT M KOKATANUR , NH4, PUNE - BANGALORE HIGHWAY, DIST.SATARA, AGASHIVNAGAR, MALKAPUR, MAHARASHTRA-415539 INDIAN
8. Whether the work is published or unpublished : UNPUBLISHED
9. Year and country of first publication and name, address and nationality of the publisher : N.A.
10. Years and countries of subsequent publications, if any, and names, addresses and nationalities of the publishers : N.A.
11. Names, addresses and nationalities of the owners of various rights comprising the copyright in the work and the extent of rights held by each, together with particulars of assignments and licences, if any : KRISHNA INSTITUTE OF MEDICAL SCIENCES "DEEMED TO BE UNIVERSITY", KARAD , NH4, PUNE - BANGALORE HIGHWAY, DIST.SATARA, AGASHIVNAGAR, MALKAPUR, MAHARASHTRA-415539 INDIAN
12. Names, addresses and nationalities of other persons, if any, authorised to assign or licence of rights comprising the copyright : KRISHNA INSTITUTE OF MEDICAL SCIENCES "DEEMED TO BE UNIVERSITY", KARAD , NH4, PUNE - BANGALORE HIGHWAY, DIST.SATARA, AGASHIVNAGAR, MALKAPUR, MAHARASHTRA-415539 INDIAN
13. If the work is an 'Artistic work', the location of the original work, including name, address and nationality of the person in possession of the work. (In the case of an architectural work, the year of completion of the work should also be shown). : N.A.
14. If the work is an 'Artistic work' which is used or capable of being used in relation to any goods or services, the application should include a certification from the Registrar of Trade Marks in terms of the provision to Sub-Section (i) of Section 45 of the Copyright Act, 1957. : N.A.
15. If the work is an 'Artistic work', whether it is registered under the Designs Act 2000 if yes give details. : N.A.
16. If the work is an 'Artistic work', capable of being registered as a design under the Designs Act 2000.whether it has been applied to an article though an industrial process and ,if yes ,the number of times it is reproduced. : N.A.
17. Remarks, if any :



Dis : 3245/2020-CO/L
19/02/2020
19/02/2020

DEPUTY REGISTRAR OF COPYRIGHTS



Dated : 29/04/2020

1. Registration Number : **L-90693/2020**
 2. Name, address and nationality of the applicant : KRISHNA INSTITUTE OF MEDICAL SCIENCES "DEEMED TO BE UNIVERSITY", KARAD , KRISHNA INSTITUTE OF MEDICAL SCIENCES "DEEMED TO BE UNIVERSITY", NEAR DHEBEWADI ROAD, MALKAPUR, KARAD, MAHARASHTRA-415539-415539
INDIAN
 3. Nature of the applicant's interest in the copyright of the work : OWNER
 4. Class and description of the work : LITERARY/ DRAMATIC WORK
 5. Title of the work : WORLD STUDENT DAY 2019 CELEBRATION IN DEPARTMENT OF FORENSIC MEDICINE AND TOXICOLOGY
 6. Language of the work : ENGLISH
 7. Name, address and nationality of the author and if the author is deceased, date of his decease : DR. CHANDRAKANT M KOKATANUR , DEPARTMENT OF FORENSIC MEDICINE & TOXICOLOGY, KRISHNA INSTITUTE OF MEDICAL SCIENCES "DEEMED TO BE UNIVERSITY, KARAD-415539
INDIAN

DR AJAY V PATIL , DEPARTMENT OF FORENSIC MEDICINE & TOXICOLOGY, KRISHNA INSTITUTE OF MEDICAL SCIENCES "DEEMED TO BE UNIVERSITY, KARAD-415539
INDIAN

DR VINAY BANNUR , DEPARTMENT OF FORENSIC MEDICINE & TOXICOLOGY, KRISHNA INSTITUTE OF MEDICAL SCIENCES "DEEMED TO BE UNIVERSITY, KARAD-415539
INDIAN
 8. Whether the work is published or unpublished : UNPUBLISHED
 9. Year and country of first publication and name, address and nationality of the publisher : N.A.
 10. Years and countries of subsequent publications, if any, and names, addresses and nationalities of the publishers : N.A.
 11. Names, addresses and nationalities of the owners of various rights comprising the copyright in the work and the extent of rights held by each, together with particulars of assignments and licences, if any : KRISHNA INSTITUTE OF MEDICAL SCIENCES "DEEMED TO BE UNIVERSITY", KARAD , KRISHNA INSTITUTE OF MEDICAL SCIENCES "DEEMED TO BE UNIVERSITY", NEAR DHEBEWADI ROAD, MALKAPUR, KARAD, MAHARASHTRA-415539-415539
INDIAN
 12. Names, addresses and nationalities of other persons, if any, authorised to assign or licence of rights comprising the copyright : N.A.
 13. If the work is an 'Artistic work', the location of the original work, including name, address and nationality of the person in possession of the work. (In the case of an architectural work, the year of completion of the work should also be shown). : N.A.
 14. If the work is an 'Artistic work' which is used or capable of being used in relation to any goods or services, the application should include a certification from the Registrar of Trade Marks in terms of the provision to Sub-Section (i) of Section 45 of the Copyright Act, 1957. : N.A.
 15. If the work is an 'Artistic work', whether it is registered under the Copyright Act, 1957, give details. : N.A.
 16. If the work is an 'Artistic work', capable of being registered as a work under the Copyright Act 2000, whether it has been applied to an industrial process and, if yes, the number of times : N.A.
 17. Registrar : **DEPUTY REGISTRAR OF COPYRIGHTS**
- Diary Number : 4986/2020-CO/L
Date of Application : 17/03/2020
Date of Receipt : 17/03/2020







Dated : 29/04/2020

1. Registration Number : **L-90728/2020**
2. Name, address and nationality of the applicant : KRISHNA INSTITUTE OF MEDICAL SCIENCES "DEEMED TO BE UNIVERSITY", KARAD , NH4, PUNE - BANGALORE HIGHWAY, DIST.SATARA, AGASHIVNAGAR, MALKAPUR, MAHARASHTRA-415539 INDIAN
3. Nature of the applicant's interest in the copyright of the work : OWNER
4. Class and description of the work : LITERARY/ DRAMATIC WORK
5. Title of the work : DEMONSTRATION OF PROCESS OF CAUSATION OF MECHANICAL INJURY I.E. CONTUSION USING OBJECT FRUIT
6. Language of the work : ENGLISH
7. Name, address and nationality of the author and if the author is deceased, date of his decease : DR AJAY VINAYAK PATIL , NH4, PUNE - BANGALORE HIGHWAY, DIST.SATARA, AGASHIVNAGAR, MALKAPUR, MAHARASHTRA-415539 INDIAN
8. Whether the work is published or unpublished : UNPUBLISHED
9. Year and country of first publication and name, address and nationality of the publisher : N.A.
10. Years and countries of subsequent publications, if any, and names, addresses and nationalities of the publishers : N.A.
11. Names, addresses and nationalities of the owners of various rights comprising the copyright in the work and the extent of rights held by each, together with particulars of assignments and licences, if any : KRISHNA INSTITUTE OF MEDICAL SCIENCES "DEEMED TO BE UNIVERSITY", KARAD , NH4, PUNE - BANGALORE HIGHWAY, DIST.SATARA, AGASHIVNAGAR, MALKAPUR, MAHARASHTRA-415539 INDIAN
12. Names, addresses and nationalities of other persons, if any, authorised to assign or licence of rights comprising the copyright : KRISHNA INSTITUTE OF MEDICAL SCIENCES "DEEMED TO BE UNIVERSITY", KARAD , NH4, PUNE - BANGALORE HIGHWAY, DIST.SATARA, AGASHIVNAGAR, MALKAPUR, MAHARASHTRA-415539 INDIAN
13. If the work is an 'Artistic work', the location of the original work, including name, address and nationality of the person in possession of the work. (In the case of an architectural work, the year of completion of the work should also be shown). : N.A.
14. If the work is an 'Artistic work' which is used or capable of being used in relation to any goods or services, the application should include a certification from the Registrar of Trade Marks in terms of the provision to Sub-Section (i) of Section 45 of the Copyright Act, 1957. : N.A.
15. If the work is an 'Artistic work', whether it is registered under the Designs Act 2000 if yes give details. : N.A.
16. If the work is an 'Artistic work', capable of being registered as a design under the Designs Act 2000, whether it has been applied to an article, or to an industrial process and ,if yes ,the number of times it is : N.A.
17. :



3189/2020-CO/L

19/02/2020

19/02/2020

DEPUTY REGISTRAR OF COPYRIGHTS



Dated : 04/05/2020

1. Registration Number : **L-91096/2020**
2. Name, address and nationality of the applicant : KRISHNA INSTITUTE OF MEDICAL SCIENCES "DEEMED TO BE UNIVERSITY", KARAD , KRISHNA INSTITUTE OF MEDICAL SCIENCES "DEEMED TO BE UNIVERSITY", NEAR DHEBEWADI ROAD, MALKAPUR, KARAD, MAHARASHTRA-415539 INDIAN
3. Nature of the applicant's interest in the copyright of the work : OWNER
4. Class and description of the work : LITERARY/ DRAMATIC WORK
5. Title of the work : STUDENT LEARNING BY PERFORMING UNDER SUPERVISION DEMONSTRATION OF MECHANICAL INJURIES USING AN OBJECT VEGETABLES
6. Language of the work : ENGLISH
7. Name, address and nationality of the author and if the author is deceased, date of his decease : DR AJAY VINAYAK PATIL , DEPARTMENT OF FORENSIC MEDICINE & TOXICOLOGY, KRISHNA INSTITUTE OF MEDICAL SCIENCES "DEEMED TO BE UNIVERSITY", NEAR DHEBEWADI ROAD, MALKAPUR, KARAD, MAHARASHTRA-415539-415539 INDIAN
8. Whether the work is published or unpublished : UNPUBLISHED
9. Year and country of first publication and name, address and nationality of the publisher : N.A.
10. Years and countries of subsequent publications, if any, and names, addresses and nationalities of the publishers : N.A.
11. Names, addresses and nationalities of the owners of various rights comprising the copyright in the work and the extent of rights held by each, together with particulars of assignments and licences, if any : KRISHNA INSTITUTE OF MEDICAL SCIENCES "DEEMED TO BE UNIVERSITY", KARAD , KRISHNA INSTITUTE OF MEDICAL SCIENCES "DEEMED TO BE UNIVERSITY", NEAR DHEBEWADI ROAD, MALKAPUR, KARAD, MAHARASHTRA-415539 INDIAN
12. Names, addresses and nationalities of other persons, if any, authorised to assign or licence of rights comprising the copyright : N.A.
13. If the work is an 'Artistic work', the location of the original work, including name, address and nationality of the person in possession of the work. (In the case of an architectural work, the year of completion of the work should also be shown). : N.A.
14. If the work is an 'Artistic work' which is used or capable of being used in relation to any goods or services, the application should include a certification from the Registrar of Trade Marks in terms of the provision to Sub-Section (i) of Section 45 of the Copyright Act, 1957. : N.A.
15. If the work is an 'Artistic work', whether it is registered under the Designs Act 2000 if yes give details. : N.A.
16. If the work is an 'Artistic work', capable of being registered as a design under the Designs Act 2000, whether it has been applied to an article though an industrial process and ,if yes ,the number of times it is reproduced. : N.A.
17. Remarks :



4641/2020-CO/L

12/03/2020

12/03/2020

DEPUTY REGISTRAR OF COPYRIGHTS



Dated : 29/04/2020

1. Registration Number : **L-90801/2020**
2. Name, address and nationality of the applicant : KRISHNA INSTITUTE OF MEDICAL SCIENCES "DEEMED TO BE UNIVERSITY", KARAD , KRISHNA INSTITUTE OF MEDICAL SCIENCES "DEEMED TO BE UNIVERSITY", KARAD, MALKAPUR, KARAD, DIST. SATARA, MAHARASHTRA, INDIA-415539
INDIAN
3. Nature of the applicant's interest in the copyright of the work : OWNER
4. Class and description of the work : LITERARY/ DRAMATIC WORK
5. Title of the work : DENTAL MASTER CHEF- DMC
6. Language of the work : ENGLISH
7. Name, address and nationality of the author and if the author is deceased, date of his decease : DR. SUSHMA R , SCHOOL OF DENTAL SCIENCES, KRISHNA INSTITUTE OF MEDICAL SCIENCES "DEEMED TO BE UNIVERSITY", KARAD-415539
INDIAN

DR. SHASHIKIRAN N D , SCHOOL OF DENTAL SCIENCES, KRISHNA INSTITUTE OF MEDICAL SCIENCES "DEEMED TO BE UNIVERSITY", KARAD-415539
INDIAN

DR. PRASHANT PUNDE , SCHOOL OF DENTAL SCIENCES, KRISHNA INSTITUTE OF MEDICAL SCIENCES "DEEMED TO BE UNIVERSITY", KARAD-415539
INDIAN
8. Whether the work is published or unpublished : UNPUBLISHED
9. Year and country of first publication and name, address and nationality of the publisher : N.A.
10. Years and countries of subsequent publications, if any, and names, addresses and nationalities of the publishers : N.A.
11. Names, addresses and nationalities of the owners of various rights comprising the copyright in the work and the extent of rights held by each, together with particulars of assignments and licences, if any : KRISHNA INSTITUTE OF MEDICAL SCIENCES "DEEMED TO BE UNIVERSITY", KARAD , KRISHNA INSTITUTE OF MEDICAL SCIENCES "DEEMED TO BE UNIVERSITY", KARAD, MALKAPUR, KARAD, DIST. SATARA, MAHARASHTRA, INDIA-415539
INDIAN
12. Names, addresses and nationalities of other persons, if any, authorised to assign or licence of rights comprising the copyright : N.A.
13. If the work is an 'Artistic work', the location of the original work, including name, address and nationality of the person in possession of the work. (In the case of an architectural work, the year of completion of the work should also be shown). : N.A.
14. If the work is an 'Artistic work' which is used or capable of being used in relation to any goods or services, the application should include a certification from the Registrar of Trade Marks in terms of the provision to Sub-Section (i) of Section 45 of the Copyright Act, 1957. : N.A.
15. If the work is an 'Artistic work', whether it is registered under the Designs Act 2000 if yes give details. : N.A.
16. If the work is an 'Artistic work', capable of being registered as a design under the Designs Act 2000, whether it has been applied to an article, the date of application, the date of registration, the date of the design process and ,if yes ,the number of times : N.A.
17. :



3974/2020-CO/L

Date of Receipt : 02/03/2020

Date of Receipt : 02/03/2020

DEPUTY REGISTRAR OF COPYRIGHTS



Dated : 29/04/2020

1. Registration Number : **L-90804/2020**
2. Name, address and nationality of the applicant : KRISHNA INSTITUTE OF MEDICAL SCIENCES "DEEMED TO BE UNIVERSITY", KARAD , KRISHNA INSTITUTE OF MEDICAL SCIENCES "DEEMED TO BE UNIVERSITY", KARAD, MALKAPUR, KARAD, DIST. SATARA, MAHARASHTRA, INDIA-415539
INDIAN
3. Nature of the applicant's interest in the copyright of the work : OWNER
4. Class and description of the work : LITERARY/ DRAMATIC WORK
5. Title of the work : DENTAL PREMIER LEAGUE- DPL
6. Language of the work : ENGLISH
7. Name, address and nationality of the author and if the author is deceased, date of his decease : DR. SUSHMA R , SCHOOL OF DENTAL SCIENCES, KRISHNA INSTITUTE OF MEDICAL SCIENCES "DEEMED TO BE UNIVERSITY", KARAD-415539
INDIAN

DR. SHASHIKIRAN N D , SCHOOL OF DENTAL SCIENCES, KRISHNA INSTITUTE OF MEDICAL SCIENCES "DEEMED TO BE UNIVERSITY", KARAD-415539
INDIAN

DR. PRASHANT PUNDE , SCHOOL OF DENTAL SCIENCES, KRISHNA INSTITUTE OF MEDICAL SCIENCES "DEEMED TO BE UNIVERSITY", KARAD-415539
INDIAN
8. Whether the work is published or unpublished : UNPUBLISHED
9. Year and country of first publication and name, address and nationality of the publisher : N.A.
10. Years and countries of subsequent publications, if any, and names, addresses and nationalities of the publishers : N.A.
11. Names, addresses and nationalities of the owners of various rights comprising the copyright in the work and the extent of rights held by each, together with particulars of assignments and licences, if any : KRISHNA INSTITUTE OF MEDICAL SCIENCES "DEEMED TO BE UNIVERSITY", KARAD , KRISHNA INSTITUTE OF MEDICAL SCIENCES "DEEMED TO BE UNIVERSITY", KARAD, MALKAPUR, KARAD, DIST. SATARA, MAHARASHTRA, INDIA-415539
INDIAN
12. Names, addresses and nationalities of other persons, if any, authorised to assign or licence of rights comprising the copyright : N.A.
13. If the work is an 'Artistic work', the location of the original work, including name, address and nationality of the person in possession of the work. (In the case of an architectural work, the year of completion of the work should also be shown). : N.A.
14. If the work is an 'Artistic work' which is used or capable of being used in relation to any goods or services, the application should include a certification from the Registrar of Trade Marks in terms of the provision to Sub-Section (i) of Section 45 of the Copyright Act, 1957. : N.A.
15. If the work is an 'Artistic work', whether it is registered under the Designs Act 2000 if yes give details. : N.A.
16. If the work is an 'Artistic work', capable of being registered as a design under the Designs Act 2000, whether it has been applied to an article, the date of application, the date of registration, if any, the date of the design process and ,if yes ,the number of times : N.A.
17. :



3981/2020-CO/L

Date of Receipt : 02/03/2020

Date of Receipt : 02/03/2020

DEPUTY REGISTRAR OF COPYRIGHTS



Dated : 29/04/2020

1. Registration Number : **L-90805/2020**
2. Name, address and nationality of the applicant : KRISHNA INSTITUTE OF MEDICAL SCIENCES "DEEMED TO BE UNIVERSITY", KARAD , KRISHNA INSTITUTE OF MEDICAL SCIENCES "DEEMED TO BE UNIVERSITY", KARAD, MALKAPUR, KARAD, DIST. SATARA, MAHARASHTRA, INDIA-415539 INDIAN
3. Nature of the applicant's interest in the copyright of the work : OWNER
4. Class and description of the work : LITERARY/ DRAMATIC WORK
5. Title of the work : DENTAL DODGE BALL PREMIER LEAGUE- DDPL
6. Language of the work : ENGLISH
7. Name, address and nationality of the author and if the author is deceased, date of his decease : DR. SUSHMA R , SCHOOL OF DENTAL SCIENCES, KRISHNA INSTITUTE OF MEDICAL SCIENCES "DEEMED TO BE UNIVERSITY", KARAD-415539 INDIAN
DR. SHASHIKIRAN N D , SCHOOL OF DENTAL SCIENCES, KRISHNA INSTITUTE OF MEDICAL SCIENCES "DEEMED TO BE UNIVERSITY", KARAD-415539 INDIAN
DR. PRASHANT PUNDE , SCHOOL OF DENTAL SCIENCES, KRISHNA INSTITUTE OF MEDICAL SCIENCES "DEEMED TO BE UNIVERSITY", KARAD-415539 INDIAN
8. Whether the work is published or unpublished : UNPUBLISHED
9. Year and country of first publication and name, address and nationality of the publisher : N.A.
10. Years and countries of subsequent publications, if any, and names, addresses and nationalities of the publishers : N.A.
11. Names, addresses and nationalities of the owners of various rights comprising the copyright in the work and the extent of rights held by each, together with particulars of assignments and licences, if any : KRISHNA INSTITUTE OF MEDICAL SCIENCES "DEEMED TO BE UNIVERSITY", KARAD , KRISHNA INSTITUTE OF MEDICAL SCIENCES "DEEMED TO BE UNIVERSITY", KARAD, MALKAPUR, KARAD, DIST. SATARA, MAHARASHTRA, INDIA-415539 INDIAN
12. Names, addresses and nationalities of other persons, if any, authorised to assign or licence of rights comprising the copyright : N.A.
13. If the work is an 'Artistic work', the location of the original work, including name, address and nationality of the person in possession of the work. (In the case of an architectural work, the year of completion of the work should also be shown). : N.A.
14. If the work is an 'Artistic work' which is used or capable of being used in relation to any goods or services, the application should include a certification from the Registrar of Trade Marks in terms of the provision to Sub-Section (i) of Section 45 of the Copyright Act, 1957. : N.A.
15. If the work is an 'Artistic work', whether it is registered under the Designs Act 2000 if yes give details. : N.A.
16. If the work is an 'Artistic work', capable of being registered as a design under the Designs Act 2000, whether it has been applied to an industrial process and ,if yes ,the number of times : N.A.
17. :



3982/2020-CO/L

Date of Receipt : 02/03/2020

Date of Receipt : 02/03/2020

DEPUTY REGISTRAR OF COPYRIGHTS



Dated : 29/04/2020

1. Registration Number : **L-90792/2020**
2. Name, address and nationality of the applicant : KRISHNA INSTITUTE OF MEDICAL SCIENCES "DEEMED TO BE UNIVERSITY", KARAD , KRISHNA INSTITUTE OF MEDICAL SCIENCES "DEEMED TO BE UNIVERSITY", KARAD, MALKAPUR, KARAD, DIST. SATARA, MAHARASHTRA, INDIA-415539 INDIAN
3. Nature of the applicant's interest in the copyright of the work : OWNER
4. Class and description of the work : LITERARY/ DRAMATIC WORK
5. Title of the work : DENTAL FUTSAL PREMIER LEAGUE- DFPL
6. Language of the work : ENGLISH
7. Name, address and nationality of the author and if the author is deceased, date of his decease : DR. SUSHMA R , SCHOOL OF DENTAL SCIENCES, KRISHNA INSTITUTE OF MEDICAL SCIENCES "DEEMED TO BE UNIVERSITY", KARAD-415539 INDIAN
DR. SHASHIKIRAN N D , SCHOOL OF DENTAL SCIENCES, KRISHNA INSTITUTE OF MEDICAL SCIENCES "DEEMED TO BE UNIVERSITY", KARAD.-415539 INDIAN
DR. PRASHANT PUNDE , SCHOOL OF DENTAL SCIENCES, KRISHNA INSTITUTE OF MEDICAL SCIENCES "DEEMED TO BE UNIVERSITY", KARAD-415539 INDIAN
8. Whether the work is published or unpublished : UNPUBLISHED
9. Year and country of first publication and name, address and nationality of the publisher : N.A.
10. Years and countries of subsequent publications, if any, and names, addresses and nationalities of the publishers : N.A.
11. Names, addresses and nationalities of the owners of various rights comprising the copyright in the work and the extent of rights held by each, together with particulars of assignments and licences, if any : KRISHNA INSTITUTE OF MEDICAL SCIENCES "DEEMED TO BE UNIVERSITY", KARAD , KRISHNA INSTITUTE OF MEDICAL SCIENCES "DEEMED TO BE UNIVERSITY", KARAD, MALKAPUR, KARAD, DIST. SATARA, MAHARASHTRA, INDIA-415539 INDIAN
12. Names, addresses and nationalities of other persons, if any, authorised to assign or licence of rights comprising the copyright : N.A.
13. If the work is an 'Artistic work', the location of the original work, including name, address and nationality of the person in possession of the work. (In the case of an architectural work, the year of completion of the work should also be shown). : N.A.
14. If the work is an 'Artistic work' which is used or capable of being used in relation to any goods or services, the application should include a certification from the Registrar of Trade Marks in terms of the provision to Sub-Section (i) of Section 45 of the Copyright Act, 1957. : N.A.
15. If the work is an 'Artistic work', whether it is registered under the Designs Act 2000 if yes give details. : N.A.
16. If the work is an 'Artistic work', capable of being registered as a design under the Designs Act 2000, whether it has been applied to an article, the date of application, the date of registration, the date of the design process and ,if yes ,the number of times : N.A.
17. :



3941/2020-CO/L

Date of Receipt : 02/03/2020

Date of Receipt : 02/03/2020

DEPUTY REGISTRAR OF COPYRIGHTS



Dated : 29/04/2020

1. Registration Number : **L-90689/2020**
2. Name, address and nationality of the applicant : KRISHNA INSTITUTE OF MEDICAL SCIENCES "DEEMED TO BE UNIVERSITY", KARAD , KRISHNA INSTITUTE OF MEDICAL SCIENCES "DEEMED TO BE UNIVERSITY", NEAR DHEBEWADI ROAD, MALKAPUR, KARAD, MAHARASHTRA-415539-415539 INDIAN
3. Nature of the applicant's interest in the copyright of the work : OWNER
4. Class and description of the work : LITERARY/ DRAMATIC WORK
5. Title of the work : FACTORS AFFECTING SOMATIC EMBRYOGENESIS
6. Language of the work : ENGLISH
7. Name, address and nationality of the author and if the author is deceased, date of his decease : MISS. JOTSNA MOHANLAL GANDHI , ASST. PROF. DEPARTMENT OF PHARMACOGNOSY, KRISHNA INSTITUTE OF MEDICAL SCIENCES DEEMED TO BE UNIVERSITY'S, KRISHNA INSTITUTE OF PHARMACY, KARAD-415539 INDIAN
DR. RAJENDRA CHANDRASHEKHAR DOJAD , DEAN, KRISHNA INSTITUTE OF MEDICAL SCIENCES DEEMED TO BE UNIVERSITY'S, KRISHNA INSTITUTE OF PHARMACY, KARAD-415539 INDIAN
8. Whether the work is published or unpublished : UNPUBLISHED
9. Year and country of first publication and name, address and nationality of the publisher : N.A.
10. Years and countries of subsequent publications, if any, and names, addresses and nationalities of the publishers : N.A.
11. Names, addresses and nationalities of the owners of various rights comprising the copyright in the work and the extent of rights held by each, together with particulars of assignments and licences, if any : KRISHNA INSTITUTE OF MEDICAL SCIENCES "DEEMED TO BE UNIVERSITY", KARAD , KRISHNA INSTITUTE OF MEDICAL SCIENCES "DEEMED TO BE UNIVERSITY", NEAR DHEBEWADI ROAD, MALKAPUR, KARAD, MAHARASHTRA-415539-415539 INDIAN
12. Names, addresses and nationalities of other persons, if any, authorised to assign or licence of rights comprising the copyright : N.A.
13. If the work is an 'Artistic work', the location of the original work, including name, address and nationality of the person in possession of the work. (In the case of an architectural work, the year of completion of the work should also be shown). : N.A.
14. If the work is an 'Artistic work' which is used or capable of being used in relation to any goods or services, the application should include a certification from the Registrar of Trade Marks in terms of the provision to Sub-Section (i) of Section 45 of the Copyright Act, 1957. : N.A.
15. If the work is an 'Artistic work', whether it is registered under the Designs Act 2000 if yes give details. : N.A.
16. If the work is an 'Artistic work', capable of being registered as a design under the Designs Act 2000, whether it has been applied to an article, industrial process and ,if yes ,the number of times : N.A.
17. :



4965/2020-CO/L

17/03/2020

Date

17/03/2020

DEPUTY REGISTRAR OF COPYRIGHTS



Dated : 20/03/2020

1. Registration Number : **L-90609/2020**
2. Name, address and nationality of the applicant : KRISHNA INSTITUTE OF MEDICAL SCIENCES "DEEMED TO BE UNIVERSITY", KARAD , NH4, PUNE - BANGALORE HIGHWAY, DIST.SATARA, AGASHIVNAGAR, MALKAPUR, MAHARASHTRA-415539 INDIAN
3. Nature of the applicant's interest in the copyright of the work : OWNER
4. Class and description of the work : LITERARY/ DRAMATIC WORK
5. Title of the work : THE EFFECT OF STRUCTURED PHYSIOTHERAPY PROGRAM ON PAIN, STRENGTH, WALKING ENDURANCE, SPEED AND OVERALL FUNCTIONAL CAPACITY OF A CHILD WITH LIMB GIRDLE MUSCULAR DYSTROPHY : A CASE REPORT
6. Language of the work : ENGLISH
7. Name, address and nationality of the author and if the author is deceased, date of his decease : DR. PRATIKSHA GAWANDE , NH4, PUNE - BANGALORE HIGHWAY, DIST.SATARA, AGASHIVNAGAR, MALKAPUR, MAHARASHTRA-415539 INDIAN
DR. MANDAR MALAWADE , NH4, PUNE - BANGALORE HIGHWAY, DIST.SATARA, AGASHIVNAGAR, MALKAPUR, MAHARASHTRA-415539 INDIAN
DR. NEELAM TEJANI , NH4, PUNE - BANGALORE HIGHWAY, DIST.SATARA, AGASHIVNAGAR, MALKAPUR, MAHARASHTRA-415539 INDIAN
8. Whether the work is published or unpublished : UNPUBLISHED
9. Year and country of first publication and name, address and nationality of the publisher : N.A.
10. Years and countries of subsequent publications, if any, and names, addresses and nationalities of the publishers : N.A.
11. Names, addresses and nationalities of the owners of various rights comprising the copyright in the work and the extent of rights held by each, together with particulars of assignments and licences, if any : KRISHNA INSTITUTE OF MEDICAL SCIENCES "DEEMED TO BE UNIVERSITY", KARAD , NH4, PUNE - BANGALORE HIGHWAY, DIST.SATARA, AGASHIVNAGAR, MALKAPUR, MAHARASHTRA-415539 INDIAN
12. Names, addresses and nationalities of other persons, if any, authorised to assign or licence of rights comprising the copyright : KRISHNA INSTITUTE OF MEDICAL SCIENCES "DEEMED TO BE UNIVERSITY", KARAD , NH4, PUNE - BANGALORE HIGHWAY, DIST.SATARA, AGASHIVNAGAR, MALKAPUR, MAHARASHTRA-415539 INDIAN
13. If the work is an 'Artistic work', the location of the original work, including name, address and nationality of the person in possession of the work. (In the case of an architectural work, the year of completion of the work should also be shown). : N.A.
14. If the work is an 'Artistic work' which is used or capable of being used in connection with goods or services, the application should be filed with the Registrar of Trade Marks in terms of Section (i) of Section 45 of the Copyright Act, 1957. : N.A.
15. If the work is an 'Artistic work', whether it is registered under the Designs Act, 2000, give details. : N.A.
16. If the work is an 'Artistic work', capable of being registered as a design under the Designs Act 2000, whether it has been applied to an article though an industrial process and ,if yes ,the number of times it is reproduced. : N.A.
17. Remarks, if any : DEPUTY REGISTRAR OF COPYRIGHTS







A handwritten signature in blue ink, consisting of a stylized, cursive script.

DEPUTY REGISTRAR OF COPYRIGHTS



Dated : 20/03/2020

1. Registration Number : **L-90610/2020**
2. Name, address and nationality of the applicant : KRISHNA INSTITUTE OF MEDICAL SCIENCES "DEEMED TO BE UNIVERSITY", KARAD , NH4, PUNE - BANGALORE HIGHWAY, DIST.SATARA, AGASHIVNAGAR, MALKAPUR, MAHARASHTRA-415539 INDIAN
3. Nature of the applicant's interest in the copyright of the work : OWNER
4. Class and description of the work : LITERARY/ DRAMATIC WORK
5. Title of the work : PHYSICAL DISABILITY PROFILE IN MENTALLY CHALLENGED CHILDREN
6. Language of the work : ENGLISH
7. Name, address and nationality of the author and if the author is deceased, date of his decease : DR. NEELAM HITESH TEJANI , NH4, PUNE - BANGALORE HIGHWAY, DIST.SATARA, AGASHIVNAGAR, MALKAPUR, MAHARASHTRA-415539 INDIAN
DR. MANDAR MALAWADE , NH4, PUNE - BANGALORE HIGHWAY, DIST.SATARA, AGASHIVNAGAR, MALKAPUR, MAHARASHTRA-415539 INDIAN
DR. PRATIKSHA GAWANDE , NH4, PUNE - BANGALORE HIGHWAY, DIST.SATARA, AGASHIVNAGAR, MALKAPUR, MAHARASHTRA-415539 INDIAN
8. Whether the work is published or unpublished : UNPUBLISHED
9. Year and country of first publication and name, address and nationality of the publisher : N.A.
10. Years and countries of subsequent publications, if any, and names, addresses and nationalities of the publishers : N.A.
11. Names, addresses and nationalities of the owners of various rights comprising the copyright in the work and the extent of rights held by each, together with particulars of assignments and licences, if any : KRISHNA INSTITUTE OF MEDICAL SCIENCES "DEEMED TO BE UNIVERSITY", KARAD , NH4, PUNE - BANGALORE HIGHWAY, DIST.SATARA, AGASHIVNAGAR, MALKAPUR, MAHARASHTRA-415539 INDIAN
12. Names, addresses and nationalities of other persons, if any, authorised to assign or licence of rights comprising the copyright : KRISHNA INSTITUTE OF MEDICAL SCIENCES "DEEMED TO BE UNIVERSITY", KARAD , NH4, PUNE - BANGALORE HIGHWAY, DIST.SATARA, AGASHIVNAGAR, MALKAPUR, MAHARASHTRA-415539 INDIAN
13. If the work is an 'Artistic work', the location of the original work, including name, address and nationality of the person in possession of the work. (In the case of an architectural work, the year of completion of the work should also be shown). : N.A.
14. If the work is an 'Artistic work' which is used or capable of being used in relation to any goods or services, the application should include the notification from the Registrar of Trade Marks in terms of the proviso to Section (i) of Section 45 of the Copyright Act, 1957 : N.A.
15. If the work is an 'Artistic work', whether it is registered under the Trade Marks Act, 1999, give details. : N.A.
16. If the work is an 'Artistic work', capable of being registered as a trademark under the Trade Marks Act 2000, whether it has been applied to an industrial process and, if yes, the number of times it has been so applied : N.A.
17. Remarks, if any :

Diary Number : 836/2020-CO/L
Date of Application : 16/01/2020
Date of Receipt : 16/01/2020

DEPUTY REGISTRAR OF COPYRIGHTS



Dated : 04/05/2020

1. Registration Number : **L-91087/2020**
2. Name, address and nationality of the applicant : KRISHNA INSTITUTE OF MEDICAL SCIENCES "DEEMED TO BE UNIVERSITY", KARAD , NH4, PUNE - BANGALORE HIGHWAY, DIST.SATARA, AGASHIVNAGAR, MALKAPUR, MAHARASHTRA-415539 INDIAN
3. Nature of the applicant's interest in the copyright of the work : OWNER
4. Class and description of the work : LITERARY/ DRAMATIC WORK
5. Title of the work : DEMONSTRATION OF PROCESS OF CAUSATION OF MECHANICAL INJURIES USING OBJECT VEGETABLES (FORENSIC MEDICINE)
6. Language of the work : ENGLISH
7. Name, address and nationality of the author and if the author is deceased, date of his decease : DR AJAY VINAYAK PATIL , NH4, PUNE - BANGALORE HIGHWAY, DIST.SATARA, AGASHIVNAGAR, MALKAPUR, MAHARASHTRA-415539 INDIAN
8. Whether the work is published or unpublished : UNPUBLISHED
9. Year and country of first publication and name, address and nationality of the publisher : N.A.
10. Years and countries of subsequent publications, if any, and names, addresses and nationalities of the publishers : N.A.
11. Names, addresses and nationalities of the owners of various rights comprising the copyright in the work and the extent of rights held by each, together with particulars of assignments and licences, if any : KRISHNA INSTITUTE OF MEDICAL SCIENCES "DEEMED TO BE UNIVERSITY", KARAD , NH4, PUNE - BANGALORE HIGHWAY, DIST.SATARA, AGASHIVNAGAR, MALKAPUR, MAHARASHTRA-415539 INDIAN
12. Names, addresses and nationalities of other persons, if any, authorised to assign or licence of rights comprising the copyright : KRISHNA INSTITUTE OF MEDICAL SCIENCES "DEEMED TO BE UNIVERSITY", KARAD , NH4, PUNE - BANGALORE HIGHWAY, DIST.SATARA, AGASHIVNAGAR, MALKAPUR, MAHARASHTRA-415539 INDIAN
13. If the work is an 'Artistic work', the location of the original work, including name, address and nationality of the person in possession of the work. (In the case of an architectural work, the year of completion of the work should also be shown). : N.A.
14. If the work is an 'Artistic work' which is used or capable of being used in relation to any goods or services, the application should include a certification from the Registrar of Trade Marks in terms of the provision to Sub-Section (i) of Section 45 of the Copyright Act, 1957. : N.A.
15. If the work is an 'Artistic work', whether it is registered under the Designs Act 2000 if yes give details. : N.A.
16. If the work is an 'Artistic work', capable of being registered as a design under the Designs Act 2000.whether it has been applied to an article though an industrial process and ,if yes ,the number of times it is reproduced. : N.A.
17. Remarks, if any :



Dis 3229/2020-CO/L
19/02/2020
19/02/2020

DEPUTY REGISTRAR OF COPYRIGHTS



Dated : 30/04/2020

1. Registration Number : **L-90881/2020**
2. Name, address and nationality of the applicant : KRISHNA INSTITUTE OF MEDICAL SCIENCES "DEEMED TO BE UNIVERSITY", KARAD , KRISHNA INSTITUTE OF MEDICAL SCIENCES "DEEMED TO BE UNIVERSITY", KARAD, MALKAPUR, KARAD, DIST. SATARA, MAHARASHTRA, INDIA-415539
INDIAN
3. Nature of the applicant's interest in the copyright of the work : OWNER
4. Class and description of the work : LITERARY/ DRAMATIC WORK
5. Title of the work : DENTAL BOX CRICKET PREMIER LEAGUE- DBPL
6. Language of the work : ENGLISH
7. Name, address and nationality of the author and if the author is deceased, date of his decease : DR. SUSHMA R , SCHOOL OF DENTAL SCIENCES, KRISHNA INSTITUTE OF MEDICAL SCIENCES "DEEMED TO BE UNIVERSITY", KARAD-415539
INDIAN

DR. SHASHIKIRAN N D , SCHOOL OF DENTAL SCIENCES, KRISHNA INSTITUTE OF MEDICAL SCIENCES "DEEMED TO BE UNIVERSITY", KARAD-415539
INDIAN

DR. PRASHANT PUNDE , SCHOOL OF DENTAL SCIENCES, KRISHNA INSTITUTE OF MEDICAL SCIENCES "DEEMED TO BE UNIVERSITY", KARAD-415539
INDIAN
8. Whether the work is published or unpublished : UNPUBLISHED
9. Year and country of first publication and name, address and nationality of the publisher : N.A.
10. Years and countries of subsequent publications, if any, and names, addresses and nationalities of the publishers : N.A.
11. Names, addresses and nationalities of the owners of various rights comprising the copyright in the work and the extent of rights held by each, together with particulars of assignments and licences, if any : KRISHNA INSTITUTE OF MEDICAL SCIENCES "DEEMED TO BE UNIVERSITY", KARAD , KRISHNA INSTITUTE OF MEDICAL SCIENCES "DEEMED TO BE UNIVERSITY", KARAD, MALKAPUR, KARAD, DIST. SATARA, MAHARASHTRA, INDIA-415539
INDIAN
12. Names, addresses and nationalities of other persons, if any, authorised to assign or licence of rights comprising the copyright : N.A.
13. If the work is an 'Artistic work', the location of the original work, including name, address and nationality of the person in possession of the work. (In the case of an architectural work, the year of completion of the work should also be shown). : N.A.
14. If the work is an 'Artistic work' which is used or capable of being used in relation to any goods or services, the application should include a certification from the Registrar of Trade Marks in terms of the provision to Sub-Section (i) of Section 45 of the Copyright Act, 1957. : N.A.
15. If the work is an 'Artistic work', whether it is registered under the Designs Act 2000 if yes give details. : N.A.
16. If the work is an 'Artistic work', capable of being registered as a design under the Designs Act 2000, whether it has been applied to an industrial process and ,if yes ,the number of times : N.A.
17. :



4031/2020-CO/L

Date of Receipt : 03/03/2020

Date of Receipt : 03/03/2020

DEPUTY REGISTRAR OF COPYRIGHTS



Dated : 30/04/2020

1. Registration Number : **L-90885/2020**
2. Name, address and nationality of the applicant : KRISHNA INSTITUTE OF MEDICAL SCIENCES "DEEMED TO BE UNIVERSITY", KARAD , KRISHNA INSTITUTE OF MEDICAL SCIENCES "DEEMED TO BE UNIVERSITY", KARAD, MALKAPUR, KARAD, DIST. SATARA, MAHARASHTRA, INDIA-415539
INDIAN
3. Nature of the applicant's interest in the copyright of the work : OWNER
4. Class and description of the work : LITERARY/ DRAMATIC WORK
5. Title of the work : UPPER LIP TO RIM FORMULA
6. Language of the work : ENGLISH
7. Name, address and nationality of the author and if the author is deceased, date of his decease : DR. ABHIJEET R KORE , SCHOOL OF DENTAL SCIENCES, KRISHNA INSTITUTE OF MEDICAL SCIENCES "DEEMED TO BE UNIVERSITY", KARAD-415539
INDIAN

DR. SUSHMA R , SCHOOL OF DENTAL SCIENCES, KRISHNA INSTITUTE OF MEDICAL SCIENCES "DEEMED TO BE UNIVERSITY", KARAD-415539
INDIAN
8. Whether the work is published or unpublished : UNPUBLISHED
9. Year and country of first publication and name, address and nationality of the publisher : N.A.
10. Years and countries of subsequent publications, if any, and names, addresses and nationalities of the publishers : N.A.
11. Names, addresses and nationalities of the owners of various rights comprising the copyright in the work and the extent of rights held by each, together with particulars of assignments and licences, if any : KRISHNA INSTITUTE OF MEDICAL SCIENCES "DEEMED TO BE UNIVERSITY", KARAD , KRISHNA INSTITUTE OF MEDICAL SCIENCES "DEEMED TO BE UNIVERSITY", KARAD, MALKAPUR, KARAD, DIST. SATARA, MAHARASHTRA, INDIA-415539
INDIAN
12. Names, addresses and nationalities of other persons, if any, authorised to assign or licence of rights comprising the copyright : N.A.
13. If the work is an 'Artistic work', the location of the original work, including name, address and nationality of the person in possession of the work. (In the case of an architectural work, the year of completion of the work should also be shown). : N.A.
14. If the work is an 'Artistic work' which is used or capable of being used in relation to any goods or services, the application should include a certification from the Registrar of Trade Marks in terms of the provision to Sub-Section (i) of Section 45 of the Copyright Act, 1957. : N.A.
15. If the work is an 'Artistic work', whether it is registered under the Designs Act 2000 if yes give details. : N.A.
16. If the work is an 'Artistic work', capable of being registered as a design under the Designs Act 2000, whether it has been applied to an article though an industrial process and ,if yes ,the number of times it is reproduced. : N.A.
17. Re :



4039/2020-CO/L
03/03/2020
03/03/2020

DEPUTY REGISTRAR OF COPYRIGHTS



Dated : 30/04/2020

1. Registration Number : **L-90883/2020**
2. Name, address and nationality of the applicant : KRISHNA INSTITUTE OF MEDICAL SCIENCES "DEEMED TO BE UNIVERSITY", KARAD , KRISHNA INSTITUTE OF MEDICAL SCIENCES "DEEMED TO BE UNIVERSITY", KARAD, MALKAPUR, KARAD, DIST. SATARA, MAHARASHTRA, INDIA-415539
INDIAN
3. Nature of the applicant's interest in the copyright of the work : OWNER
4. Class and description of the work : LITERARY/ DRAMATIC WORK
5. Title of the work : LOWER LIP TO RIM FORMULA
6. Language of the work : ENGLISH
7. Name, address and nationality of the author and if the author is deceased, date of his decease : DR. ABHIJEET R KORE , SCHOOL OF DENTAL SCIENCES, KRISHNA INSTITUTE OF MEDICAL SCIENCES "DEEMED TO BE UNIVERSITY", KARAD-415539
INDIAN

DR. SUSHMA R , SCHOOL OF DENTAL SCIENCES, KRISHNA INSTITUTE OF MEDICAL SCIENCES "DEEMED TO BE UNIVERSITY", KARAD-415539
INDIAN
8. Whether the work is published or unpublished : UNPUBLISHED
9. Year and country of first publication and name, address and nationality of the publisher : N.A.
10. Years and countries of subsequent publications, if any, and names, addresses and nationalities of the publishers : N.A.
11. Names, addresses and nationalities of the owners of various rights comprising the copyright in the work and the extent of rights held by each, together with particulars of assignments and licences, if any : KRISHNA INSTITUTE OF MEDICAL SCIENCES "DEEMED TO BE UNIVERSITY", KARAD , KRISHNA INSTITUTE OF MEDICAL SCIENCES "DEEMED TO BE UNIVERSITY", KARAD, MALKAPUR, KARAD, DIST. SATARA, MAHARASHTRA, INDIA-415539
INDIAN
12. Names, addresses and nationalities of other persons, if any, authorised to assign or licence of rights comprising the copyright : N.A.
13. If the work is an 'Artistic work', the location of the original work, including name, address and nationality of the person in possession of the work. (In the case of an architectural work, the year of completion of the work should also be shown). : N.A.
14. If the work is an 'Artistic work' which is used or capable of being used in relation to any goods or services, the application should include a certification from the Registrar of Trade Marks in terms of the provision to Sub-Section (i) of Section 45 of the Copyright Act, 1957. : N.A.
15. If the work is an 'Artistic work', whether it is registered under the Designs Act 2000 if yes give details. : N.A.
16. If the work is an 'Artistic work', capable of being registered as a design under the Designs Act 2000.whether it has been applied to an article though an industrial process and ,if yes ,the number of times it is reproduced. : N.A.
17. Re :



4034/2020-CO/L
03/03/2020
03/03/2020

DEPUTY REGISTRAR OF COPYRIGHTS



Dated : 04/05/2020

1. Registration Number : **L-91042/2020**
2. Name, address and nationality of the applicant : KRISHNA INSTITUTE OF MEDICAL SCIENCES "DEEMED TO BE UNIVERSITY", KARAD , DEPARTMENT OF FORENSIC MEDICINE & TOXICOLOGY, KRISHNA INSTITUTE OF MEDICAL SCIENCES "DEEMED TO BE UNIVERSITY", NEAR DHEBEWADI ROAD, MALKAPUR, KARAD, MAHARASHTRA-415539 INDIAN
3. Nature of the applicant's interest in the copyright of the work : OWNER
4. Class and description of the work : LITERARY/ DRAMATIC WORK
5. Title of the work : STUDENT LEARNING BY PERFORMING UNDER SUPERVISION DEMONSTRATION OF MECHANICAL INJURY CONTUSION USING AN OBJECT FRUIT
6. Language of the work : ENGLISH
7. Name, address and nationality of the author and if the author is deceased, date of his decease : DR AJAY VINAYAK PATIL , DEPARTMENT OF FORENSIC MEDICINE & TOXICOLOGY, KRISHNA INSTITUTE OF MEDICAL SCIENCES "DEEMED TO BE UNIVERSITY", NEAR DHEBEWADI ROAD, MALKAPUR, KARAD, MAHARASHTRA-415539 INDIAN
8. Whether the work is published or unpublished : UNPUBLISHED
9. Year and country of first publication and name, address and nationality of the publisher : N.A.
10. Years and countries of subsequent publications, if any, and names, addresses and nationalities of the publishers : N.A.
11. Names, addresses and nationalities of the owners of various rights comprising the copyright in the work and the extent of rights held by each, together with particulars of assignments and licences, if any : KRISHNA INSTITUTE OF MEDICAL SCIENCES "DEEMED TO BE UNIVERSITY", KARAD , DEPARTMENT OF FORENSIC MEDICINE & TOXICOLOGY, KRISHNA INSTITUTE OF MEDICAL SCIENCES "DEEMED TO BE UNIVERSITY", NEAR DHEBEWADI ROAD, MALKAPUR, KARAD, MAHARASHTRA-415539 INDIAN
12. Names, addresses and nationalities of other persons, if any, authorised to assign or licence of rights comprising the copyright : N.A.
13. If the work is an 'Artistic work', the location of the original work, including name, address and nationality of the person in possession of the work. (In the case of an architectural work, the year of completion of the work should also be shown). : N.A.
14. If the work is an 'Artistic work' which is used or capable of being used in relation to any goods or services, the application should include a certification from the Registrar of Trade Marks in terms of the provision to Sub-Section (i) of Section 45 of the Copyright Act, 1957. : N.A.
15. If the work is an 'Artistic work', whether it is registered under the Designs Act 2000 if yes give details. : N.A.
16. If the work is an 'Artistic work', capable of being registered as a design under the Designs Act 2000, whether it has been applied to an article through an industrial process and ,if yes ,the number of times it is reproduced : N.A.
17. F :



4616/2020-CO/L
12/03/2020
12/03/2020

DEPUTY REGISTRAR OF COPYRIGHTS



Dated : 08/05/2020

1. Registration Number : **L-91194/2020**
2. Name, address and nationality of the applicant : KRISHNA INSTITUTE OF MEDICAL SCIENCES "DEEMED TO BE UNIVERSITY", KARAD , NH4, PUNE - BANGALORE HIGHWAY, DIST.SATARA, AGASHIVNAGAR, MALKAPUR, MAHARASHTRA-415539
INDIAN
3. Nature of the applicant's interest in the copyright of the work : OWNER
4. Class and description of the work : LITERARY/ DRAMATIC WORK
5. Title of the work : ZEBRA CROSSING-DEPICTING MEASURES FOR PREVENTION OF ROAD TRAFFIC ACCIDENTS (FORENSIC MEDICINE)
6. Language of the work : ENGLISH
7. Name, address and nationality of the author and if the author is deceased, date of his decease : DR AJAY VINAYAK PATIL , NH4, PUNE - BANGALORE HIGHWAY, DIST.SATARA, AGASHIVNAGAR, MALKAPUR, MAHARASHTRA-415539
INDIAN

DR CHANDRAKANT M. KOKATANUR , NH4, PUNE - BANGALORE HIGHWAY, DIST.SATARA, AGASHIVNAGAR, MALKAPUR, MAHARASHTRA-415539
INDIAN

DR VINAY BANNUR , NH4, PUNE - BANGALORE HIGHWAY, DIST.SATARA, AGASHIVNAGAR, MALKAPUR, MAHARASHTRA-415539
INDIAN

UMANSHI LAL , NH4, PUNE - BANGALORE HIGHWAY, DIST.SATARA, AGASHIVNAGAR, MALKAPUR, MAHARASHTRA-415539
INDIAN

TWINKLE DAHIA , NH4, PUNE - BANGALORE HIGHWAY, DIST.SATARA, AGASHIVNAGAR, MALKAPUR, MAHARASHTRA-415539
INDIAN

NAZREEN FATMA , NH4, PUNE - BANGALORE HIGHWAY, DIST.SATARA, AGASHIVNAGAR, MALKAPUR, MAHARASHTRA-415539
INDIAN
8. Whether the work is published or unpublished : UNPUBLISHED
9. Year and country of first publication and name, address and nationality of the publisher : N.A.
10. Years and countries of subsequent publications, if any, and names, addresses and nationalities of the publishers : N.A.
11. Names, addresses and nationalities of the owners of various rights comprising the copyright in the work and the extent of rights held by each, together with particulars of assignments and licences, if any : KRISHNA INSTITUTE OF MEDICAL SCIENCES "DEEMED TO BE UNIVERSITY", KARAD , NH4, PUNE - BANGALORE HIGHWAY, DIST.SATARA, AGASHIVNAGAR, MALKAPUR, MAHARASHTRA-415539
INDIAN
12. Names, addresses and nationalities of other persons, if any, authorised to assign or licence of rights comprising the copyright : KRISHNA INSTITUTE OF MEDICAL SCIENCES "DEEMED TO BE UNIVERSITY", KARAD , NH4, PUNE - BANGALORE HIGHWAY, DIST.SATARA, AGASHIVNAGAR, MALKAPUR, MAHARASHTRA-415539
INDIAN
13. If the work is an 'Artistic work', the location of the original work, and nationality of the person in possession of an architectural work, the year of (should also be shown). : N.A. 
14. If the work is an 'Artistic work' which is used or capable of being used in relation to any goods or services, the application should include a certification from the Registrar of Trade Marks in terms of the provision to Sub-Section (i) of Section 45 of the Copyright Act, 1957. : N.A. **DEPUTY REGISTRAR OF COPYRIGHTS**
15. If the work is an 'Artistic work', whether it is registered under the Designs Act 2000 if yes give details. : N.A.



16. If the work is an 'Artistic work', capable of being registered as a design under the Designs Act 2000, whether it has been applied to an article through an industrial process and, if yes, the number of times it is reproduced. : N.A.

17. Remarks, if any :

Diary Number : 3568/2020-CO/L

Date of Application : 25/02/2020

Date of Receipt : 25/02/2020



A handwritten signature in blue ink, appearing to read 'M. M. M. S.', is written over a faint rectangular stamp.

DEPUTY REGISTRAR OF COPYRIGHTS



Dated : 08/05/2020

1. Registration Number : **L-91187/2020**
2. Name, address and nationality of the applicant : KRISHNA INSTITUTE OF MEDICAL SCIENCES "DEEMED TO BE UNIVERSITY", KARAD , NH4, PUNE - BANGALORE HIGHWAY, DIST.SATARA, AGASHIVNAGAR, MALKAPUR, MAHARASHTRA-415539
INDIAN
3. Nature of the applicant's interest in the copyright of the work : OWNER
4. Class and description of the work : LITERARY/ DRAMATIC WORK
5. Title of the work : DO NOT 'DRINK & DRIVE' (ALCOHOLIC DRINKS) & ALWAYS WEAR A SEATBELT
6. Language of the work : ENGLISH
7. Name, address and nationality of the author and if the author is deceased, date of his decease : DR. CHANDRAKANT M KOKATANUR , NH4, PUNE - BANGALORE HIGHWAY, DIST.SATARA, AGASHIVNAGAR, MALKAPUR, MAHARASHTRA-415539
INDIAN

DR AJAY V PATIL , NH4, PUNE - BANGALORE HIGHWAY, DIST.SATARA, AGASHIVNAGAR, MALKAPUR, MAHARASHTRA-415539
INDIAN

DR VINAY BANNUR , NH4, PUNE - BANGALORE HIGHWAY, DIST.SATARA, AGASHIVNAGAR, MALKAPUR, MAHARASHTRA-415539
INDIAN

TANYA VOHRA , NH4, PUNE - BANGALORE HIGHWAY, DIST.SATARA, AGASHIVNAGAR, MALKAPUR, MAHARASHTRA-415539
INDIAN

NAZREEN FATEMA , NH4, PUNE - BANGALORE HIGHWAY, DIST.SATARA, AGASHIVNAGAR, MALKAPUR, MAHARASHTRA-415539
INDIAN
8. Whether the work is published or unpublished : UNPUBLISHED
9. Year and country of first publication and name, address and nationality of the publisher : N.A.
10. Years and countries of subsequent publications, if any, and names, addresses and nationalities of the publishers : N.A.
11. Names, addresses and nationalities of the owners of various rights comprising the copyright in the work and the extent of rights held by each, together with particulars of assignments and licences, if any : KRISHNA INSTITUTE OF MEDICAL SCIENCES "DEEMED TO BE UNIVERSITY", KARAD , NH4, PUNE - BANGALORE HIGHWAY, DIST.SATARA, AGASHIVNAGAR, MALKAPUR, MAHARASHTRA-415539
INDIAN
12. Names, addresses and nationalities of other persons, if any, authorised to assign or licence of rights comprising the copyright : KRISHNA INSTITUTE OF MEDICAL SCIENCES "DEEMED TO BE UNIVERSITY", KARAD , NH4, PUNE - BANGALORE HIGHWAY, DIST.SATARA, AGASHIVNAGAR, MALKAPUR, MAHARASHTRA-415539
INDIAN
13. If the work is an 'Artistic work', the location of the original work, including the address and nationality of the person in possession of the work (in the case of an architectural work, the year of construction of the work should also be shown). : N.A.
14. If the work is a 'work of applied art' which is used or capable of being used in connection with goods or services, the application should be made to the Registrar of Trade Marks in terms of section (i) of Section 45 of the Copyright Act, : N.A.
15. If the work is an 'Artistic work', whether it is registered under the Designs Act, 2000 if yes give details. : N.A.
16. If the work is an 'Artistic work', capable of being registered as a design under the Designs Act 2000, whether it has been applied to an article through an industrial process and, if yes, the number of times it is reproduced. : N.A.
17. Remarks, if any :



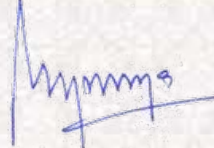

DEPUTY REGISTRAR OF COPYRIGHTS

Diary Number : 3562/2020-CO/L
Date of Application : 25/02/2020
Date of Receipt : 25/02/2020



A handwritten signature in blue ink, appearing to read "M. M. M. S.", is written over a faint rectangular stamp.

DEPUTY REGISTRAR OF COPYRIGHTS



Dated : 08/05/2020

1. Registration Number : **L-91191/2020**
2. Name, address and nationality of the applicant : KRISHNA INSTITUTE OF MEDICAL SCIENCES "DEEMED TO BE UNIVERSITY", KARAD , NH4, PUNE - BANGALORE HIGHWAY, DIST.SATARA, AGASHIVNAGAR, MALKAPUR, MAHARASHTRA-415539
INDIAN
3. Nature of the applicant's interest in the copyright of the work : OWNER
4. Class and description of the work : LITERARY/ DRAMATIC WORK
5. Title of the work : DO NOT USE HEADPHONES AND LISTEN TO LOUD MUSIC WHILE DRIVING
6. Language of the work : ENGLISH
7. Name, address and nationality of the author and if the author is deceased, date of his decease : DR. CHANDRAKANT M KOKATANUR , NH4, PUNE - BANGALORE HIGHWAY, DIST.SATARA, AGASHIVNAGAR, MALKAPUR, MAHARASHTRA-415539
INDIAN

DR AJAY V PATIL , NH4, PUNE - BANGALORE HIGHWAY, DIST.SATARA, AGASHIVNAGAR, MALKAPUR, MAHARASHTR-415539
INDIAN

DR VINAY BANNUR , NH4, PUNE - BANGALORE HIGHWAY, DIST.SATARA, AGASHIVNAGAR, MALKAPUR, MAHARASHTRA-415539
INDIAN

SWARAJ GANDHI , NH4, PUNE - BANGALORE HIGHWAY, DIST.SATARA, AGASHIVNAGAR, MALKAPUR, MAHARASHTRA-415539
INDIAN

TAMANNA RAI , NH4, PUNE - BANGALORE HIGHWAY, DIST.SATARA, AGASHIVNAGAR, MALKAPUR, MAHARASHTRA-415539
INDIAN

NAZREEN FATEMA , NH4, PUNE - BANGALORE HIGHWAY, DIST.SATARA, AGASHIVNAGAR, MALKAPUR, MAHARASHTRA-415539
INDIAN
8. Whether the work is published or unpublished : UNPUBLISHED
9. Year and country of first publication and name, address and nationality of the publisher : N.A.
10. Years and countries of subsequent publications, if any, and names, addresses and nationalities of the publishers : N.A.
11. Names, addresses and nationalities of the owners of various rights comprising the copyright in the work and the extent of rights held by each, together with particulars of assignments and licences, if any : KRISHNA INSTITUTE OF MEDICAL SCIENCES "DEEMED TO BE UNIVERSITY", KARAD , NH4, PUNE - BANGALORE HIGHWAY, DIST.SATARA, AGASHIVNAGAR, MALKAPUR, MAHARASHTRA-415539
INDIAN
12. Names, addresses and nationalities of other persons, if any, authorised to assign or licence of rights comprising the copyright : KRISHNA INSTITUTE OF MEDICAL SCIENCES "DEEMED TO BE UNIVERSITY", KARAD , NH4, PUNE - BANGALORE HIGHWAY, DIST.SATARA, AGASHIVNAGAR, MALKAPUR, MAHARASHTRA-415539
INDIAN
13. If the work is an 'Artistic work', the location of the original work, and nationality of the person in possession of an architectural work, the year of should also be shown). : N.A.
14. If the work is an 'Artistic work' which is used or capable of being used in any goods or services, the application should include information from the Registrar of Trade Marks in terms of the provision to Sub-Section (i) of Section 45 of the Copyright Act, 1957. : N.A.
15. If the work is an 'Artistic work', whether it is registered under the Designs Act 2000 if yes give details. : N.A.

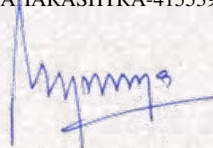

DEPUTY REGISTRAR OF COPYRIGHTS

16. If the work is an 'Artistic work', capable of being registered as a design under the Designs Act 2000.whether it has been applied to an article through an industrial process and ,if yes ,the number of times it is reproduced. : N.A.

17. Remarks, if any :

Diary Number : 3564/2020-CO/L

Date of Application : 25/02/2020

Date of Receipt : 25/02/2020



A handwritten signature in blue ink, appearing to read 'M. M. M. S.', is written over a faint rectangular stamp.

DEPUTY REGISTRAR OF COPYRIGHTS



Dated : 08/05/2020

1. Registration Number : **L-91185/2020**
2. Name, address and nationality of the applicant : KRISHNA INSTITUTE OF MEDICAL SCIENCES "DEEMED TO BE UNIVERSITY", KARAD , NH4, PUNE - BANGALORE HIGHWAY, DIST.SATARA, AGASHIVNAGAR, MALKAPUR, MAHARASHTRA-415539
INDIAN
3. Nature of the applicant's interest in the copyright of the work : OWNER
4. Class and description of the work : LITERARY/ DRAMATIC WORK
5. Title of the work : DO NOT USE COMMUNICATION DEVICES WHEN TRAVELLING ON ROAD-DEPICTING MEASURES FOR PREVENTION OF ROAD TRAFFIC ACCIDENTS
6. Language of the work : ENGLISH
7. Name, address and nationality of the author and if the author is deceased, date of his decease : DR AJAY VINAYAK PATIL , NH4, PUNE - BANGALORE HIGHWAY, DIST.SATARA, AGASHIVNAGAR, MALKAPUR, MAHARASHTRA-415539
INDIAN

DR CHANDRAKANT M. KOKATANUR , NH4, PUNE - BANGALORE HIGHWAY, DIST.SATARA, AGASHIVNAGAR, MALKAPUR, MAHARASHTRA-415539
INDIAN

DR VINAY BANNUR , NH4, PUNE - BANGALORE HIGHWAY, DIST.SATARA, AGASHIVNAGAR, MALKAPUR, MAHARASHTRA-415539
INDIAN

VAISHNAV SETHUMADHAVAN , NH4, PUNE - BANGALORE HIGHWAY, DIST.SATARA, AGASHIVNAGAR, MALKAPUR, MAHARASHTRA-415539
INDIAN

VAISHALI AGGARWAL , NH4, PUNE - BANGALORE HIGHWAY, DIST.SATARA, AGASHIVNAGAR, MALKAPUR, MAHARASHTRA-415539
INDIAN

NAZREEN FATMA , NH4, PUNE - BANGALORE HIGHWAY, DIST.SATARA, AGASHIVNAGAR, MALKAPUR, MAHARASHTRA-415539
INDIAN
8. Whether the work is published or unpublished : UNPUBLISHED
9. Year and country of first publication and name, address and nationality of the publisher : N.A.
10. Years and countries of subsequent publications, if any, and names, addresses and nationalities of the publishers : N.A.
11. Names, addresses and nationalities of the owners of various rights comprising the copyright in the work and the extent of rights held by each, together with particulars of assignments and licences, if any : KRISHNA INSTITUTE OF MEDICAL SCIENCES "DEEMED TO BE UNIVERSITY", KARAD , NH4, PUNE - BANGALORE HIGHWAY, DIST.SATARA, AGASHIVNAGAR, MALKAPUR, MAHARASHTRA-415539
INDIAN
12. Names, addresses and nationalities of other persons, if any, authorised to assign or licence of rights comprising the copyright : KRISHNA INSTITUTE OF MEDICAL SCIENCES "DEEMED TO BE UNIVERSITY", KARAD , NH4, PUNE - BANGALORE HIGHWAY, DIST.SATARA, AGASHIVNAGAR, MALKAPUR, MAHARASHTRA-415539
INDIAN
13. If the work is an 'Artistic work', the location of the original work, and nationality of the person in possession of an architectural work, the year of (should also be shown). : N.A.
14. If the work is an 'Artistic work' which is used or capable of being used in relation to any goods or services, the application should include a certification from the Registrar of Trade Marks in terms of the provision to Sub-Section (i) of Section 45 of the Copyright Act, 1957. : N.A. 
15. If the work is an 'Artistic work', whether it is registered under the Designs Act 2000 if yes give details. : N.A.



DEPUTY REGISTRAR OF COPYRIGHTS

16. If the work is an 'Artistic work', capable of being registered as a design under the Designs Act 2000, whether it has been applied to an article through an industrial process and, if yes, the number of times it is reproduced. : N.A.

17. Remarks, if any :

Diary Number : 3567/2020-CO/L

Date of Application : 25/02/2020

Date of Receipt : 25/02/2020



A handwritten signature in blue ink, appearing to read 'M. M. M. S.', is written over a faint rectangular stamp.

DEPUTY REGISTRAR OF COPYRIGHTS



Dated : 08/05/2020

1. Registration Number : **L-91195/2020**
2. Name, address and nationality of the applicant : KRISHNA INSTITUTE OF MEDICAL SCIENCES "DEEMED TO BE UNIVERSITY", KARAD , NH4, PUNE - BANGALORE HIGHWAY, DIST.SATARA, AGASHIVNAGAR, MALKAPUR, MAHARASHTRA-415539 INDIAN
3. Nature of the applicant's interest in the copyright of the work : OWNER
4. Class and description of the work : LITERARY/ DRAMATIC WORK
5. Title of the work : PHOTOGRAPHS SHOWING THE STAGES OF MICROPROPAGATION OF SEED CULTURE IN GROUND NUT SEEDS (ARACHIS HYPOGEA)
6. Language of the work : ENGLISH
7. Name, address and nationality of the author and if the author is deceased, date of his decease : MRS. SNEHAL ANAND MASURKAR , NH4, PUNE - BANGALORE HIGHWAY, DIST.SATARA, AGASHIVNAGAR, MALKAPUR, MAHARASHTRA-415539 INDIAN
DR. S. C. KALE , NH4, PUNE - BANGALORE HIGHWAY, DIST.SATARA, AGASHIVNAGAR, MALKAPUR, MAHARASHTRA-415539 INDIAN
8. Whether the work is published or unpublished : UNPUBLISHED
9. Year and country of first publication and name, address and nationality of the publisher : N.A.
10. Years and countries of subsequent publications, if any, and names, addresses and nationalities of the publishers : N.A.
11. Names, addresses and nationalities of the owners of various rights comprising the copyright in the work and the extent of rights held by each, together with particulars of assignments and licences, if any : KRISHNA INSTITUTE OF MEDICAL SCIENCES "DEEMED TO BE UNIVERSITY", KARAD , NH4, PUNE - BANGALORE HIGHWAY, DIST.SATARA, AGASHIVNAGAR, MALKAPUR, MAHARASHTRA-415539 INDIAN
12. Names, addresses and nationalities of other persons, if any, authorised to assign or licence of rights comprising the copyright : KRISHNA INSTITUTE OF MEDICAL SCIENCES "DEEMED TO BE UNIVERSITY", KARAD , NH4, PUNE - BANGALORE HIGHWAY, DIST.SATARA, AGASHIVNAGAR, MALKAPUR, MAHARASHTRA-415539 INDIAN
13. If the work is an 'Artistic work', the location of the original work, including name, address and nationality of the person in possession of the work. (In the case of an architectural work, the year of completion of the work should also be shown). : N.A.
14. If the work is an 'Artistic work' which is used or capable of being used in relation to any goods or services, the application should include a certification from the Registrar of Trade Marks in terms of the provision to Sub-Section (i) of Section 45 of the Copyright Act, 1957. : N.A.
15. If the work is an 'Artistic work', whether it is registered under the Designs Act 2000 if yes give details. : N.A.
16. If the work is an 'Artistic work', capable of being registered as a design under the Designs Act 2000, whether it has been applied to an article of handicraft or industrial process and ,if yes ,the number of times it has been so applied. : N.A.
17. :



3570/2020-CO/L

25/02/2020

Date

25/02/2020

DEPUTY REGISTRAR OF COPYRIGHTS



Dated : 04/06/2020

1. Registration Number : **L-91790/2020**
2. Name, address and nationality of the applicant : KRISHNA INSTITUTE OF MEDICAL SCIENCES " DEEMED TO BE UNIVERSITY" KARAD , KRISHNA INSTITUTE OF MEDICAL SCIENCES "DEEMED TO BE UNIVERSITY", KARAD, MALKAPUR, MAHARASHTRA-415539 INDIAN
3. Nature of the applicant's interest in the copyright of the work : OWNER
4. Class and description of the work : LITERARY/ DRAMATIC WORK
5. Title of the work : RELEVANCE OF BIOETHICS IN DENTISTRY
6. Language of the work : ENGLISH
7. Name, address and nationality of the author and if the author is deceased, date of his decease : DR. RENUKA PAWAR , DEPARTMENT OF ORTHODONTICS AND DENTOFACIAL ORTHOPAEDICS, SCHOOL OF DENTAL SCIENCES, KRISHNA INSTITUTE OF MEDICAL SCIENCES " DEEMED TO BE UNIVERSITY" KARAD-415539 INDIAN
DR. KARISHMA SARODE , DEPARTMENT OF ORTHODONTICS AND DENTOFACIAL ORTHOPAEDICS, SCHOOL OF DENTAL SCIENCES, KRISHNA INSTITUTE OF MEDICAL SCIENCES " DEEMED TO BE UNIVERSITY" KARAD-415539 INDIAN
8. Whether the work is published or unpublished : UNPUBLISHED
9. Year and country of first publication and name, address and nationality of the publisher : N.A.
10. Years and countries of subsequent publications, if any, and names, addresses and nationalities of the publishers : N.A.
11. Names, addresses and nationalities of the owners of various rights comprising the copyright in the work and the extent of rights held by each, together with particulars of assignments and licences, if any : KRISHNA INSTITUTE OF MEDICAL SCIENCES " DEEMED TO BE UNIVERSITY" KARAD , KRISHNA INSTITUTE OF MEDICAL SCIENCES "DEEMED TO BE UNIVERSITY", NEAR DHEBEWADI ROAD, MALKAPUR, KARAD, MAHARASHTRA-415539 INDIAN
12. Names, addresses and nationalities of other persons, if any, authorised to assign or licence of rights comprising the copyright : N.A.
13. If the work is an 'Artistic work', the location of the original work, including name, address and nationality of the person in possession of the work. (In the case of an architectural work, the year of completion of the work should also be shown). : N.A.
14. If the work is an 'Artistic work' which is used or capable of being used in relation to any goods or services, the application should include a certification from the Registrar of Trade Marks in terms of the provision to Sub-Section (i) of Section 45 of the Copyright Act, 1957. : N.A.
15. If the work is an 'Artistic work', whether it is registered under the Designs Act 2000 if yes give details. : N.A.
16. If the work is an 'Artistic work', capable of being registered as a design under the Designs Act 2000, whether it has been applied to an article, or to an industrial process and, if yes, the number of times it is so applied : N.A.
17. :



5156/2020-CO/L

18/03/2020

18/03/2020

DEPUTY REGISTRAR OF COPYRIGHTS



Dated : 04/06/2020

1. Registration Number : **L-91791/2020**
2. Name, address and nationality of the applicant : KRISHNA INSTITUTE OF MEDICAL SCIENCES "DEEMED TO BE UNIVERSITY", KARAD , KRISHNA INSTITUTE OF MEDICAL SCIENCES "DEEMED TO BE UNIVERSITY", KARAD, MALKAPUR, KARAD, DIST. SATARA, MAHARASHTRA, INDIA-415539
INDIAN
3. Nature of the applicant's interest in the copyright of the work : OWNER
4. Class and description of the work : LITERARY/ DRAMATIC WORK
5. Title of the work : TOOL TO ASSESS KNOWLEDGE AND PRACTICES OF CHILDREN (10 YEARS TO 18 YEARS) WITH TYPE 1 DIABETES MELLITUS
6. Language of the work : ENGLISH
7. Name, address and nationality of the author and if the author is deceased, date of his decease : MRS. RAJASHRI BHAGWAT KARALE , KRISHNA INSTITUTE OF MEDICAL SCIENCES "DEEMED TO BE UNIVERSITY", KARAD, MALKAPUR, KARAD, DIST. SATARA, MAHARASHTRA, INDIA-415539
INDIAN

DR. P. M. DURGAWALE , KRISHNA INSTITUTE OF MEDICAL SCIENCES "DEEMED TO BE UNIVERSITY", KARAD, MALKAPUR, KARAD, DIST. SATARA, MAHARASHTRA, INDIA-415539
INDIAN

DR. S. V. KAKADE , KRISHNA INSTITUTE OF MEDICAL SCIENCES "DEEMED TO BE UNIVERSITY", KARAD, MALKAPUR, KARAD, DIST. SATARA, MAHARASHTRA, INDIA-415539
INDIAN
8. Whether the work is published or unpublished : UNPUBLISHED
9. Year and country of first publication and name, address and nationality of the publisher : N.A.
10. Years and countries of subsequent publications, if any, and names, addresses and nationalities of the publishers : N.A.
11. Names, addresses and nationalities of the owners of various rights comprising the copyright in the work and the extent of rights held by each, together with particulars of assignments and licences, if any : KRISHNA INSTITUTE OF MEDICAL SCIENCES "DEEMED TO BE UNIVERSITY", KARAD , KRISHNA INSTITUTE OF MEDICAL SCIENCES "DEEMED TO BE UNIVERSITY", KARAD, MALKAPUR, KARAD, DIST. SATARA, MAHARASHTRA, INDIA-415539
INDIAN
12. Names, addresses and nationalities of other persons, if any, authorised to assign or licence of rights comprising the copyright : N.A.
13. If the work is an 'Artistic work', the location of the original work, including name, address and nationality of the person in possession of the work. (In the case of an architectural work, the year of completion of the work should also be shown). : N.A.
14. If the work is an 'Artistic work' which is used or capable of being used in relation to any goods or services, the application should include a certification from the Registrar of Trade Marks in terms of the provisions of Sub-Section (i) of Section 45 of the Copyright Act, 1957 : N.A.
15. If the work is an 'Artistic work', whether it is registered under the provisions of the Copyright Act, 1957, give details. : N.A.
16. If the work is an 'Artistic work', capable of being registered as a trademark under the Trademarks Act 2000, whether it has been applied to an article, the date of application, the date of registration, if any, the date of renewal, if any, the number of times it has been renewed, and the date of expiry of the registration, if any : N.A.
17. Remarks : 

DEPUTY REGISTRAR OF COPYRIGHTS

Diary Number : 5160/2020-CO/L
Date of Application : 18/03/2020
Date of Receipt : 18/03/2020



Dated : 03/06/2020

- | | | |
|--|---|---|
| 1. Registration Number | : | L-91770/2020 |
| 2. Name, address and nationality of the applicant | : | KRISHNA INSTITUTE OF MEDICAL SCIENCES "DEEMED TO BE UNIVERSITY", KARAD , NH4, PUNE - BANGALORE HIGHWAY, DIST.SATARA, AGASHIVNAGAR, MALKAPUR, MAHARASHTRA-415539
INDIAN |
| 3. Nature of the applicant's interest in the copyright of the work | : | OWNER |
| 4. Class and description of the work | : | LITERARY/ DRAMATIC WORK |
| 5. Title of the work | : | DEAN'S COFFEE CLUB: THE UNIQUE INITIATIVE TO PROMOTE STUDENT ATTENDANCE AT SCHOOL OF DENTAL SCIENCES, KIMSDU, KARAD |
| 6. Language of the work | : | ENGLISH |
| 7. Name, address and nationality of the author and if the author is deceased, date of his decease | : | DR. SHASHIKIRAN ND , NH4, PUNE - BANGALORE HIGHWAY, DIST.SATARA, AGASHIVNAGAR, MALKAPUR, MAHARASHTRA-415539
INDIAN

DR. NUPURA VIBHUTE , NH4, PUNE - BANGALORE HIGHWAY, DIST.SATARA, AGASHIVNAGAR, MALKAPUR, MAHARASHTRA-415539
INDIAN

DR. ABHIJEET SANDE , NH4, PUNE - BANGALORE HIGHWAY, DIST.SATARA, AGASHIVNAGAR, MALKAPUR, MAHARASHTRA-415539
INDIAN |
| 8. Whether the work is published or unpublished | : | UNPUBLISHED |
| 9. Year and country of first publication and name, address and nationality of the publisher | : | N.A. |
| 10. Years and countries of subsequent publications, if any, and names, addresses and nationalities of the publishers | : | N.A. |
| 11. Names, addresses and nationalities of the owners of various rights comprising the copyright in the work and the extent of rights held by each, together with particulars of assignments and licences, if any | : | KRISHNA INSTITUTE OF MEDICAL SCIENCES "DEEMED TO BE UNIVERSITY", KARAD , NH4, PUNE - BANGALORE HIGHWAY, DIST.SATARA, AGASHIVNAGAR, MALKAPUR, MAHARASHTRA-415539
INDIAN |
| 12. Names, addresses and nationalities of other persons, if any, authorised to assign or licence of rights comprising the copyright | : | KRISHNA INSTITUTE OF MEDICAL SCIENCES "DEEMED TO BE UNIVERSITY", KARAD , NH4, PUNE - BANGALORE HIGHWAY, DIST.SATARA, AGASHIVNAGAR, MALKAPUR, MAHARASHTRA-415539
INDIAN |
| 13. If the work is an 'Artistic work', the location of the original work, including name, address and nationality of the person in possession of the work. (In the case of an architectural work, the year of completion of the work should also be shown). | : | N.A. |
| 14. If the work is an 'Artistic work' which is used or capable of being used in relation to any goods or services, the application should include a declaration from the Registrar of Trade Marks in terms of the proviso to Section (i) of Section 45 of the Copyright Act, 1957. | : | N.A. |
| 15. If the work is an 'Artistic work', whether it is registered under the Trade Marks Act, 1999, give details. | : | N.A. |
| 16. If the work is an 'Artistic work', capable of being registered as a trademark under the Trade Marks Act 2000, whether it has been applied to an industrial process and, if yes, the number of times it has been so applied. | : | N.A. |
| 17. Remarks, if any | : | |

Diary Number : 3119/2020-CO/L
Date of Application : 18/02/2020
Date of Receipt : 18/02/2020

DEPUTY REGISTRAR OF COPYRIGHTS



Dated : 03/06/2020

1. Registration Number : **L-91769/2020**
2. Name, address and nationality of the applicant : KRISHNA INSTITUTE OF MEDICAL SCIENCES "DEEMED TO BE UNIVERSITY", KARAD , NH4, PUNE - BANGALORE HIGHWAY, DIST.SATARA, AGASHIVNAGAR, MALKAPUR, MAHARASHTRA-415539 INDIAN
3. Nature of the applicant's interest in the copyright of the work : OWNER
4. Class and description of the work : LITERARY/ DRAMATIC WORK
5. Title of the work : MAY I HELP YOU-INNOVATIVE CONCEPT TO GUIDE AND MOTIVATE PATIENTS FOR TREATMENT AT SCHOOL OF DENTAL SCIENCES, KIMSDU, KARAD
6. Language of the work : ENGLISH
7. Name, address and nationality of the author and if the author is deceased, date of his decease : DR. SHASHIKIRAN ND , NH4, PUNE - BANGALORE HIGHWAY, DIST.SATARA, AGASHIVNAGAR, MALKAPUR, MAHARASHTRA-415539 INDIAN
DR. ABHIJEET SANDE , NH4, PUNE - BANGALORE HIGHWAY, DIST.SATARA, AGASHIVNAGAR, MALKAPUR, MAHARASHTRA-415539 INDIAN
DR. ABHIJEET KORE , NH4, PUNE - BANGALORE HIGHWAY, DIST.SATARA, AGASHIVNAGAR, MALKAPUR, MAHARASHTRA-415539 INDIAN
DR. KARUNA PAWASHE , NH4, PUNE - BANGALORE HIGHWAY, DIST.SATARA, AGASHIVNAGAR, MALKAPUR, MAHARASHTRA-415539 INDIAN
8. Whether the work is published or unpublished : UNPUBLISHED
9. Year and country of first publication and name, address and nationality of the publisher : N.A.
10. Years and countries of subsequent publications, if any, and names, addresses and nationalities of the publishers : N.A.
11. Names, addresses and nationalities of the owners of various rights comprising the copyright in the work and the extent of rights held by each, together with particulars of assignments and licences, if any : KRISHNA INSTITUTE OF MEDICAL SCIENCES "DEEMED TO BE UNIVERSITY", KARAD , NH4, PUNE - BANGALORE HIGHWAY, DIST.SATARA, AGASHIVNAGAR, MALKAPUR, MAHARASHTRA-415539 INDIAN
12. Names, addresses and nationalities of other persons, if any, authorised to assign or licence of rights comprising the copyright : KRISHNA INSTITUTE OF MEDICAL SCIENCES "DEEMED TO BE UNIVERSITY", KARAD , NH4, PUNE - BANGALORE HIGHWAY, DIST.SATARA, AGASHIVNAGAR, MALKAPUR, MAHARASHTRA-415539 INDIAN
13. If the work is an 'Artistic work', the location of the original work, including name, address and nationality of the person in possession of the work. (In the case of an architectural work, the year of completion of the work should also be shown). : N.A.
14. If the work is an 'Artistic work' which is used or capable of being used in connection with goods or services, the application should be filed from the Registrar of Trade Marks in terms of Section (i) of Section 45 of the Copyright Act, : N.A.
15. If the work is an 'Artistic work', whether it is registered under the Designs Act 2000, give details. : N.A.
16. If the work is an 'Artistic work', capable of being registered as a design under the Designs Act 2000, whether it has been applied to an article though an industrial process and, if yes, the number of times it is reproduced. : N.A.
17. Remarks, if any : DEPUTY REGISTRAR OF COPYRIGHTS







A handwritten signature in blue ink, consisting of a stylized, cursive script.

DEPUTY REGISTRAR OF COPYRIGHTS



Dated : 30/04/2020

1. Registration Number : **L-90952/2020**
2. Name, address and nationality of the applicant : KRISHNA INSTITUTE OF MEDICAL SCIENCES "DEEMED TO BE UNIVERSITY", KARAD , KRISHNA INSTITUTE OF MEDICAL SCIENCES "DEEMED TO BE UNIVERSITY", KARAD, MALKAPUR, KARAD, DIST. SATARA, MAHARASHTRA, INDIA-415539
INDIAN
3. Nature of the applicant's interest in the copyright of the work : OWNER
4. Class and description of the work : LITERARY/ DRAMATIC WORK
5. Title of the work : GRAPHICAL PRESENTATION OF BODY MASS INDEX OF ANTENATAL WOMEN WHO GAVE BIRTH TO BIRTH TO NORMAL BIRTH WEIGHT BABIES AND LOW BIRTH WEIGHT BABIES
6. Language of the work : ENGLISH
7. Name, address and nationality of the author and if the author is deceased, date of his decease : MRS. NITANJALI VAIBHAV PATIL , KRISHNA INSTITUTE OF MEDICAL SCIENCES "DEEMED TO BE UNIVERSITY", KARAD, MALKAPUR, KARAD, DIST. SATARA, MAHARASHTRA, INDIA-415539
INDIAN

DR. R. P. PATANGE , KRISHNA INSTITUTE OF MEDICAL SCIENCES "DEEMED TO BE UNIVERSITY", KARAD, MALKAPUR, KARAD, DIST. SATARA, MAHARASHTRA, INDIA-415539
INDIAN

DR. VAISHALI R. MOHITE , KRISHNA INSTITUTE OF MEDICAL SCIENCES "DEEMED TO BE UNIVERSITY", KARAD, MALKAPUR, KARAD, DIST. SATARA, MAHARASHTRA, INDIA-415539
INDIAN

DR. S.V. KAKADE , KRISHNA INSTITUTE OF MEDICAL SCIENCES "DEEMED TO BE UNIVERSITY", KARAD, MALKAPUR, KARAD, DIST. SATARA, MAHARASHTRA, INDIA-415539
INDIAN

DR. JYOTI A. SALUNKHE , KRISHNA INSTITUTE OF MEDICAL SCIENCES "DEEMED TO BE UNIVERSITY", KARAD, MALKAPUR, KARAD, DIST. SATARA, MAHARASHTRA, INDIA-415539
INDIAN
8. Whether the work is published or unpublished : UNPUBLISHED
9. Year and country of first publication and name, address and nationality of the publisher : N.A.
10. Years and countries of subsequent publications, if any, and names, addresses and nationalities of the publishers : N.A.
11. Names, addresses and nationalities of the owners of various rights comprising the copyright in the work and the extent of rights held by each, together with particulars of assignments and licences, if any : KRISHNA INSTITUTE OF MEDICAL SCIENCES "DEEMED TO BE UNIVERSITY", KARAD , KRISHNA INSTITUTE OF MEDICAL SCIENCES "DEEMED TO BE UNIVERSITY", KARAD, MALKAPUR, KARAD, DIST. SATARA, MAHARASHTRA, INDIA-415539
INDIAN
12. Names and nationalities of other persons, if any, who have been granted a licence of rights comprising the copyright : N.A.
13. If the work is an 'Artistic work', the location of the original work, and nationality of the person in possession of an architectural work, the year of construction (if any) should also be shown). : N.A.
14. If the work is an 'Artistic work' which is used or capable of being used in connection with any goods or services, the application should include a certification from the Registrar of Trade Marks in terms of the provision to Sub-Section (i) of Section 45 of the Copyright Act, 1957. : N.A.
15. If the work is an 'Artistic work', whether it is registered under the Designs Act 2000 if yes give details. : N.A.



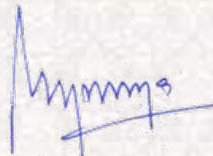

DEPUTY REGISTRAR OF COPYRIGHTS

16. If the work is an 'Artistic work', capable of being registered as a design under the Designs Act 2000, whether it has been applied to an article through an industrial process and, if yes, the number of times it is reproduced. : N.A.

17. Remarks, if any :

Diary Number : 4451/2020-CO/L

Date of Application : 09/03/2020

Date of Receipt : 09/03/2020



A handwritten signature in blue ink, appearing to read "M. M. M. S.", is written over a faint rectangular stamp.

DEPUTY REGISTRAR OF COPYRIGHTS



Dated : 30/04/2020

1. Registration Number : **L-90939/2020**
2. Name, address and nationality of the applicant : KRISHNA INSTITUTE OF MEDICAL SCIENCES "DEEMED TO BE UNIVERSITY", KARAD , KRISHNA INSTITUTE OF MEDICAL SCIENCES "DEEMED TO BE UNIVERSITY", KARAD, MALKAPUR, KARAD, DIST. SATARA, MAHARASHTRA, INDIA-415539
INDIAN
3. Nature of the applicant's interest in the copyright of the work : OWNER
4. Class and description of the work : LITERARY/ DRAMATIC WORK
5. Title of the work : COMPARISON BETWEEN QUALITY OF LIFE WOMEN WHO GAVE BIRTH TO NORMAL BIRTH WEIGHT BABIES AND LOW BIRTH WEIGHT BABIES DURING THEIR PREGNANCY
6. Language of the work : ENGLISH
7. Name, address and nationality of the author and if the author is deceased, date of his decease : MRS. NITANJALI VAIBHAV PATIL , KRISHNA INSTITUTE OF MEDICAL SCIENCES "DEEMED TO BE UNIVERSITY", KARAD, MALKAPUR, KARAD, DIST. SATARA, MAHARASHTRA, INDIA-415539
INDIAN

DR. R. P. PATANGE , KRISHNA INSTITUTE OF MEDICAL SCIENCES "DEEMED TO BE UNIVERSITY", KARAD, MALKAPUR, KARAD, DIST. SATARA, MAHARASHTRA, INDIA-415539
INDIAN

DR. VAISHALI R. MOHITE , KRISHNA INSTITUTE OF MEDICAL SCIENCES "DEEMED TO BE UNIVERSITY", KARAD, MALKAPUR, KARAD, DIST. SATARA, MAHARASHTRA, INDIA-415539
INDIAN

DR. SUPRIYA PATIL , KRISHNA INSTITUTE OF MEDICAL SCIENCES "DEEMED TO BE UNIVERSITY", KARAD, MALKAPUR, KARAD, DIST. SATARA, MAHARASHTRA, INDIA-415539
INDIAN

MRS. SHEETAL A. KADAM , KRISHNA INSTITUTE OF MEDICAL SCIENCES "DEEMED TO BE UNIVERSITY", KARAD, MALKAPUR, KARAD, DIST. SATARA, MAHARASHTRA, INDIA-415539
INDIAN
8. Whether the work is published or unpublished : UNPUBLISHED
9. Year and country of first publication and name, address and nationality of the publisher : N.A.
10. Years and countries of subsequent publications, if any, and names, addresses and nationalities of the publishers : N.A.
11. Names, addresses and nationalities of the owners of various rights comprising the copyright in the work and the extent of rights held by each, together with particulars of assignments and licences, if any : KRISHNA INSTITUTE OF MEDICAL SCIENCES "DEEMED TO BE UNIVERSITY", KARAD , KRISHNA INSTITUTE OF MEDICAL SCIENCES "DEEMED TO BE UNIVERSITY", KARAD, MALKAPUR, KARAD, DIST. SATARA, MAHARASHTRA, INDIA-415539
INDIAN
12. Names, addresses and nationalities of other persons, if any, and licence of rights comprising the copyright : N.A.
13. Name, address and nationality of the person in possession of the work, the location of the original work, and nationality of the person in possession of an architectural work, the year of creation should also be shown). : N.A.
14. If the work is an 'Artistic work' which is used or capable of being used in any goods or services, the application should include a declaration from the Registrar of Trade Marks in terms of the provision to Sub-Section (i) of Section 45 of the Copyright Act, 1957. : N.A.
15. If the work is an 'Artistic work', whether it is registered under the Designs Act 2000 if yes give details. : N.A.



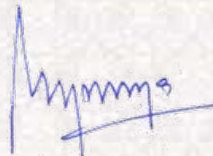

DEPUTY REGISTRAR OF COPYRIGHTS

16. If the work is an 'Artistic work', capable of being registered as a design under the Designs Act 2000, whether it has been applied to an article through an industrial process and, if yes, the number of times it is reproduced. : N.A.

17. Remarks, if any :

Diary Number : 4455/2020-CO/L

Date of Application : 09/03/2020

Date of Receipt : 09/03/2020



A handwritten signature in blue ink, appearing to read 'M. M. M. S.', is written over a faint rectangular stamp.

DEPUTY REGISTRAR OF COPYRIGHTS



Dated : 04/05/2020

1. Registration Number : **L-91041/2020**
2. Name, address and nationality of the applicant : KRISHNA INSTITUTE OF MEDICAL SCIENCES "DEEMED TO BE UNIVERSITY", KARAD , KRISHNA INSTITUTE OF MEDICAL SCIENCES "DEEMED TO BE UNIVERSITY", KARAD, MALKAPUR, KARAD, DIST. SATARA, MAHARASHTRA, INDIA-415539
INDIAN
3. Nature of the applicant's interest in the copyright of the work : OWNER
4. Class and description of the work : LITERARY/ DRAMATIC WORK
5. Title of the work : STRUCTURED ORTHOPEDIC MANUAL THERAPY ASSESSMENT PROFORMA
6. Language of the work : ENGLISH
7. Name, address and nationality of the author and if the author is deceased, date of his decease : DR. RADHIKA CHINTAMANI , KRISHNA COLLEGE OF PHYSIOTHERAPY, KRISHNA INSTITUTE OF MEDICAL SCIENCES "DEEMED TO BE UNIVERSITY", KARAD, MALKAPUR, DIST. SATARA, MAHARASHTRA, INDIA-415539
INDIAN

DR. G. VARADHARAJULU , KRISHNA COLLEGE OF PHYSIOTHERAPY, KRISHNA INSTITUTE OF MEDICAL SCIENCES "DEEMED TO BE UNIVERSITY", KARAD, MALKAPUR, DIST. SATARA, MAHARASHTRA, INDIA-415539
INDIAN

DR. AMRUTKUVAR RAYJADE , KRISHNA COLLEGE OF PHYSIOTHERAPY, KRISHNA INSTITUTE OF MEDICAL SCIENCES "DEEMED TO BE UNIVERSITY", KARAD, MALKAPUR, DIST. SATARA, MAHARASHTRA, INDIA-415539
INDIAN
8. Whether the work is published or unpublished : UNPUBLISHED
9. Year and country of first publication and name, address and nationality of the publisher : N.A.
10. Years and countries of subsequent publications, if any, and names, addresses and nationalities of the publishers : N.A.
11. Names, addresses and nationalities of the owners of various rights comprising the copyright in the work and the extent of rights held by each, together with particulars of assignments and licences, if any : KRISHNA INSTITUTE OF MEDICAL SCIENCES "DEEMED TO BE UNIVERSITY", KARAD , KRISHNA INSTITUTE OF MEDICAL SCIENCES "DEEMED TO BE UNIVERSITY", KARAD, MALKAPUR, KARAD, DIST. SATARA, MAHARASHTRA, INDIA-415539
INDIAN
12. Names, addresses and nationalities of other persons, if any, authorised to assign or licence of rights comprising the copyright : N.A.
13. If the work is an 'Artistic work', the location of the original work, including name, address and nationality of the person in possession of the work. (In the case of an architectural work, the year of completion of the work should also be shown). : N.A.
14. If the work is an 'Artistic work' which is used or capable of being used in connection to any goods or services, the application should include information from the Registrar of Trade Marks in terms of the Section (i) of Section 45 of the Copyright Act, : N.A.
15. If the work is an 'Artistic work', whether it is registered under the : N.A.
Give details.
16. If the work is an 'Artistic work', capable of being registered as a : N.A.
design under the Designs Act 2000, whether it has been applied to an article, or to an industrial process and ,if yes ,the number of times it is registered.
17. Remarks, if any :



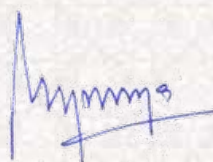

DEPUTY REGISTRAR OF COPYRIGHTS

Diary Number : 4476/2020-CO/L

Date of Application : 09/03/2020

Date of Receipt : 09/03/2020



Dated : 30/04/2020

1. Registration Number : **L-90984/2020**
2. Name, address and nationality of the applicant : KRISHNA INSTITUTE OF MEDICAL SCIENCES "DEEMED TO BE UNIVERSITY", KARAD , KRISHNA INSTITUTE OF MEDICAL SCIENCES "DEEMED TO BE UNIVERSITY", KARAD, MALKAPUR, KARAD, DIST. SATARA, MAHARASHTRA, INDIA-415539 INDIAN
3. Nature of the applicant's interest in the copyright of the work : OWNER
4. Class and description of the work : LITERARY/ DRAMATIC WORK
5. Title of the work : LIST PRINCIPLE FOR TREATING SOFT TISSUE INJURIES
6. Language of the work : ENGLISH
7. Name, address and nationality of the author and if the author is deceased, date of his decease : DR. PRASANNAJEET PRAMOD NIKAM , DEPARTMENT OF SPORTS PHYSIOTHERAPY, KRISHNA INSTITUTE OF MEDICAL SCIENCES "DEEMED TO BE UNIVERSITY", KARAD, MALKAPUR, DIST. SATARA, MAHARASHTRA, INDIA-415539 INDIAN
8. Whether the work is published or unpublished : UNPUBLISHED
9. Year and country of first publication and name, address and nationality of the publisher : N.A.
10. Years and countries of subsequent publications, if any, and names, addresses and nationalities of the publishers : N.A.
11. Names, addresses and nationalities of the owners of various rights comprising the copyright in the work and the extent of rights held by each, together with particulars of assignments and licences, if any : KRISHNA INSTITUTE OF MEDICAL SCIENCES "DEEMED TO BE UNIVERSITY", KARAD , KRISHNA INSTITUTE OF MEDICAL SCIENCES "DEEMED TO BE UNIVERSITY", KARAD, MALKAPUR, KARAD, DIST. SATARA, MAHARASHTRA, INDIA-415539 INDIAN
12. Names, addresses and nationalities of other persons, if any, authorised to assign or licence of rights comprising the copyright : N.A.
13. If the work is an 'Artistic work', the location of the original work, including name, address and nationality of the person in possession of the work. (In the case of an architectural work, the year of completion of the work should also be shown). : N.A.
14. If the work is an 'Artistic work' which is used or capable of being used in relation to any goods or services, the application should include a certification from the Registrar of Trade Marks in terms of the provision to Sub-Section (i) of Section 45 of the Copyright Act, 1957. : N.A.
15. If the work is an 'Artistic work', whether it is registered under the Designs Act 2000 if yes give details. : N.A.
16. If the work is an 'Artistic work', capable of being registered as a design under the Designs Act 2000.whether it has been applied to an article though an industrial process and ,if yes ,the number of times it is reproduced. : N.A.
17. Remarks, if any :



Dis : 4472/2020-CO/L
09/03/2020
09/03/2020

DEPUTY REGISTRAR OF COPYRIGHTS



Dated : 30/04/2020

1. Registration Number : **L-90867/2020**
2. Name, address and nationality of the applicant : KRISHNA INSTITUTE OF MEDICAL SCIENCES "DEEMED TO BE UNIVERSITY", KARAD , KRISHNA INSTITUTE OF MEDICAL SCIENCES "DEEMED TO BE UNIVERSITY", KARAD, MALKAPUR, KARAD, DIST. SATARA, MAHARASHTRA, INDIA-415539
INDIAN
3. Nature of the applicant's interest in the copyright of the work : OWNER
4. Class and description of the work : LITERARY/ DRAMATIC WORK
5. Title of the work : INTERNET USERS AND SECURITY SYSTEM: RETROSPECTIVE DATA STUDY
6. Language of the work : ENGLISH
7. Name, address and nationality of the author and if the author is deceased, date of his decease : MR. DHIRAJKUMAR MANE , KRISHNA INSTITUTE OF MEDICAL SCIENCES "DEEMED TO BE UNIVERSITY", KARAD, MALKAPUR, KARAD, DIST. SATARA, MAHARASHTRA, INDIA-415539
INDIAN

MR. MAHENDRA ALATE , KRISHNA INSTITUTE OF MEDICAL SCIENCES "DEEMED TO BE UNIVERSITY", KARAD, MALKAPUR, KARAD, DIST. SATARA, MAHARASHTRA, INDIA-415539
INDIAN
8. Whether the work is published or unpublished : UNPUBLISHED
9. Year and country of first publication and name, address and nationality of the publisher : N.A.
10. Years and countries of subsequent publications, if any, and names, addresses and nationalities of the publishers : N.A.
11. Names, addresses and nationalities of the owners of various rights comprising the copyright in the work and the extent of rights held by each, together with particulars of assignments and licences, if any : KRISHNA INSTITUTE OF MEDICAL SCIENCES "DEEMED TO BE UNIVERSITY", KARAD , KRISHNA INSTITUTE OF MEDICAL SCIENCES "DEEMED TO BE UNIVERSITY", KARAD, MALKAPUR, KARAD, DIST. SATARA, MAHARASHTRA, INDIA-415539
INDIAN
12. Names, addresses and nationalities of other persons, if any, authorised to assign or licence of rights comprising the copyright : N.A.
13. If the work is an 'Artistic work', the location of the original work, including name, address and nationality of the person in possession of the work. (In the case of an architectural work, the year of completion of the work should also be shown). : N.A.
14. If the work is an 'Artistic work' which is used or capable of being used in relation to any goods or services, the application should include a certification from the Registrar of Trade Marks in terms of the provision to Sub-Section (i) of Section 45 of the Copyright Act, 1957. : N.A.
15. If the work is an 'Artistic work', whether it is registered under the Designs Act 2000 if yes give details. : N.A.
16. If the work is an 'Artistic work', capable of being registered as a design under the Designs Act 2000, whether it has been applied to an article, or to an industrial process and ,if yes ,the number of times : N.A.
17. :



4445/2020-CO/L

09/03/2020

Date

09/03/2020

DEPUTY REGISTRAR OF COPYRIGHTS



Dated : 03/06/2020

- | | | |
|---|---|--|
| 1. Registration Number | : | L-91762/2020 |
| 2. Name, address and nationality of the applicant | : | KRISHNA INSTITUTE OF MEDICAL SCIENCES "DEEMED TO BE UNIVERSITY", KARAD , KRISHNA INSTITUTE OF MEDICAL SCIENCES DEEMED TO BE UNIVERSITY, MALKAPUR- 415539, KARAD. MAHARASHTRA, INDIA-415539 INDIAN |
| 3. Nature of the applicant's interest in the copyright of the work | : | OWNER |
| 4. Class and description of the work | : | LITERARY/ DRAMATIC WORK |
| 5. Title of the work | : | PROCEDURE FOR MAKING ASH BASED DISH WASH BAR AT HOME |
| 6. Language of the work | : | ENGLISH |
| 7. Name, address and nationality of the author and if the author is deceased, date of his decease | : | MRS. SHILPA SANDEEP RUIKAR , FACULTY OF ALLIED SCIENCES, MICROBIOLOGY, BIOTECHNOLOGY, KRISHNA INSTITUTE OF MEDICAL SCIENCES DEEMED TO BE UNIVERSITY, MALKAPUR- 415539, KARAD. MAHARASHTRA, INDIA.-415539 INDIAN

MRS. PALLAVI RAHUL RAJOPADHYE , KRISHNA INSTITUTE OF MEDICAL SCIENCES DEEMED TO BE UNIVERSITY, MALKAPUR- 415539, KARAD. MAHARASHTRA, INDIA.-415539 INDIAN

DR. S. C. KALE , KRISHNA INSTITUTE OF MEDICAL SCIENCES DEEMED TO BE UNIVERSITY, MALKAPUR- 415539, KARAD. MAHARASHTRA, INDIA.-415539 INDIAN |
| 8. Whether the work is published or unpublished | : | UNPUBLISHED |
| 9. Year and country of first publication and name, address and nationality of the publisher | : | N.A. |
| 10. Years and countries of subsequent publications, if any, and names, addresses and nationalities of the publishers | : | N.A. |
| 11. Names, addresses and nationalities of the owners of various rights comprising the copyright in the work and the extent of rights held by each, together with particulars of assignments and licences, if any | : | KRISHNA INSTITUTE OF MEDICAL SCIENCES "DEEMED TO BE UNIVERSITY", KARAD , KRISHNA INSTITUTE OF MEDICAL SCIENCES DEEMED TO BE UNIVERSITY, MALKAPUR- 415539, KARAD. MAHARASHTRA, INDIA-415539 INDIAN |
| 12. Names, addresses and nationalities of other persons, if any, authorised to assign or licence of rights comprising the copyright | : | N.A. |
| 13. If the work is an 'Artistic work', the location of the original work, including name, address and nationality of the person in possession of the work. (In the case of an architectural work, the year of completion of the work should also be shown). | : | N.A. |
| 14. If the work is an 'Artistic work' which is used or capable of being used in relation to any goods or services, the application should include a certification from the Registrar of Trade Marks in terms of the provisions of Sub-Section (i) of Section 45 of the Copyright Act, 1957. | : | N.A. |
| 15. If the work is an 'Artistic work', whether it is registered under the provisions of the Copyright Act, 1957. If yes, give details. | : | N.A. |
| 16. If the work is an 'Artistic work', capable of being registered as a trademark under the provisions of the Trademarks Act 2000, whether it has been applied to any goods or services, if yes, the number of times it has been applied. | : | N.A. |
| 17. Remarks | : | |

Diary Number : 5084/2020-CO/L
Date of Application : 18/03/2020
Date of Receipt : 18/03/2020

DEPUTY REGISTRAR OF COPYRIGHTS



Dated : 03/06/2020

1. Registration Number : **L-91740/2020**
2. Name, address and nationality of the applicant : KRISHNA INSTITUTE OF MEDICAL SCIENCES "DEEMED TO BE UNIVERSITY", KARAD , KRISHNA INSTITUTE OF MEDICAL SCIENCES DEEMED TO BE UNIVERSITY, KARAD, MALKAPUR, MAHARASHTRA, INDIA-415539 INDIAN
3. Nature of the applicant's interest in the copyright of the work : OWNER
4. Class and description of the work : LITERARY/ DRAMATIC WORK
5. Title of the work : TABLES FOR CALCULATION OF SOLUBILITY PARAMETERS OF MEFLOQUINE HYDROCHLORIDE BY DIFFERENT METHODS
6. Language of the work : ENGLISH
7. Name, address and nationality of the author and if the author is deceased, date of his decease : DR. AMOL S. SHETE , DEPARTMENT OF PHARMACEUTICS, KRISHNA INSTITUTE OF PHARMACY OF KRISHNA INSTITUTE OF MEDICAL SCIENCES DEEMED TO BE UNIVERSITY, KARAD, INDIA.-415539 INDIAN
DR. RAJENDRA C.DOIJAD , DEPARTMENT OF PHARMACEUTICS, KRISHNA INSTITUTE OF PHARMACY OF KRISHNA INSTITUTE OF MEDICAL SCIENCES DEEMED TO BE UNIVERSITY, KARAD, INDIA.-415539 INDIAN
8. Whether the work is published or unpublished : UNPUBLISHED
9. Year and country of first publication and name, address and nationality of the publisher : N.A.
10. Years and countries of subsequent publications, if any, and names, addresses and nationalities of the publishers : N.A.
11. Names, addresses and nationalities of the owners of various rights comprising the copyright in the work and the extent of rights held by each, together with particulars of assignments and licences, if any : KRISHNA INSTITUTE OF MEDICAL SCIENCES "DEEMED TO BE UNIVERSITY", KARAD , KRISHNA INSTITUTE OF MEDICAL SCIENCES DEEMED TO BE UNIVERSITY, KARAD, MALKAPUR, MAHARASHTRA, INDIA-415539 INDIAN
12. Names, addresses and nationalities of other persons, if any, authorised to assign or licence of rights comprising the copyright : N.A.
13. If the work is an 'Artistic work', the location of the original work, including name, address and nationality of the person in possession of the work. (In the case of an architectural work, the year of completion of the work should also be shown). : N.A.
14. If the work is an 'Artistic work' which is used or capable of being used in relation to any goods or services, the application should include a certification from the Registrar of Trade Marks in terms of the provision to Sub-Section (i) of Section 45 of the Copyright Act, 1957. : N.A.
15. If the work is an 'Artistic work', whether it is registered under the Designs Act 2000 if yes give details. : N.A.
16. If the work is an 'Artistic work', capable of being registered as a design under the Designs Act 2000, whether it has been applied to an industrial process and ,if yes ,the number of times : N.A.
17. :



5127/2020-CO/L

Date of Receipt : 18/03/2020

Date of Receipt : 18/03/2020

DEPUTY REGISTRAR OF COPYRIGHTS



Dated : 03/06/2020

1. Registration Number : **L-91743/2020**
2. Name, address and nationality of the applicant : KRISHNA INSTITUTE OF MEDICAL SCIENCES "DEEMED TO BE UNIVERSITY", KARAD , KRISHNA INSTITUTE OF MEDICAL SCIENCES DEEMED TO BE UNIVERSITY, KARAD, MALKAPUR, MAHARASHTRA, INDIA.-415539 INDIAN
3. Nature of the applicant's interest in the copyright of the work : OWNER
4. Class and description of the work : LITERARY/ DRAMATIC WORK
5. Title of the work : MNEMONIC FOR REMEMBERING PROPORTION OF OIL WATER GUM USED FOR PREPARATION OF PRIMARY EMULSION
6. Language of the work : ENGLISH
7. Name, address and nationality of the author and if the author is deceased, date of his decease : MRS. SWATI BABASO UDUGADE , DEPARTMENT OF PHARMACEUTICS, KRISHNA INSTITUTE OF MEDICAL SCIENCES DEEMED TO BE UNIVERSITY, KARAD, MALKAPUR, MAHARASHTRA, INDIA-415539 INDIAN
DR. R.C. DOJJAD , DEPARTMENT OF PHARMACEUTICS, KRISHNA INSTITUTE OF MEDICAL SCIENCES DEEMED TO BE UNIVERSITY, KARAD, MALKAPUR, MAHARASHTRA, INDIA-415539 INDIAN
8. Whether the work is published or unpublished : UNPUBLISHED
9. Year and country of first publication and name, address and nationality of the publisher : N.A.
10. Years and countries of subsequent publications, if any, and names, addresses and nationalities of the publishers : N.A.
11. Names, addresses and nationalities of the owners of various rights comprising the copyright in the work and the extent of rights held by each, together with particulars of assignments and licences, if any : KRISHNA INSTITUTE OF MEDICAL SCIENCES "DEEMED TO BE UNIVERSITY", KARAD , KRISHNA INSTITUTE OF MEDICAL SCIENCES DEEMED TO BE UNIVERSITY, KARAD, MALKAPUR, MAHARASHTRA, INDIA.-415539 INDIAN
12. Names, addresses and nationalities of other persons, if any, authorised to assign or licence of rights comprising the copyright : N.A.
13. If the work is an 'Artistic work', the location of the original work, including name, address and nationality of the person in possession of the work. (In the case of an architectural work, the year of completion of the work should also be shown). : N.A.
14. If the work is an 'Artistic work' which is used or capable of being used in relation to any goods or services, the application should include a certification from the Registrar of Trade Marks in terms of the provision to Sub-Section (i) of Section 45 of the Copyright Act, 1957. : N.A.
15. If the work is an 'Artistic work', whether it is registered under the Designs Act 2000 if yes give details. : N.A.
16. If the work is an 'Artistic work', capable of being registered as a design under the Designs Act 2000.whether it has been applied to an article used in an industrial process and ,if yes ,the number of times it is : N.A.
17. :



5151/2020-CO/L

18/03/2020

18/03/2020

DEPUTY REGISTRAR OF COPYRIGHTS



Dated : 19/05/2020

1. Registration Number : **L-91280/2020**
2. Name, address and nationality of the applicant : KRISHNA INSTITUTE OF MEDICAL SCIENCES "DEEMED TO BE UNIVERSITY", KARAD , KRISHNA INSTITUTE OF MEDICAL SCIENCES "DEEMED TO BE UNIVERSITY", KARAD, MALKAPUR, KARAD, DIST. SATARA, MAHARASHTRA, INDIA-415539
INDIAN
3. Nature of the applicant's interest in the copyright of the work : OWNER
4. Class and description of the work : LITERARY/ DRAMATIC WORK
5. Title of the work : UNCONVENTIONAL DENTAL PROCEDURES
6. Language of the work : ENGLISH
7. Name, address and nationality of the author and if the author is deceased, date of his decease : DR. BHAVNA M. AHUJA , PROSTHODONTICS & CROWN & BRIDGE,
SCHOOL OF DENTAL SCIENCES,
KRISHNA INSTITUTE OF MEDICAL SCIENCES
"DEEMED TO BE UNIVERSITY", KARAD-415539
INDIAN

DR. PRONOB KUMAR SANYAL , PROSTHODONTICS & CROWN & BRIDGE,
SCHOOL OF DENTAL SCIENCES,
KRISHNA INSTITUTE OF MEDICAL SCIENCES
"DEEMED TO BE UNIVERSITY", KARAD-415539
INDIAN

DR. SHUBHA JOSHI , PROSTHODONTICS & CROWN & BRIDGE,
SCHOOL OF DENTAL SCIENCES,
KRISHNA INSTITUTE OF MEDICAL SCIENCES
"DEEMED TO BE UNIVERSITY", KARAD-415539
INDIAN

DR. SHIVSAGAR TEWARY , PROSTHODONTICS & CROWN & BRIDGE,
SCHOOL OF DENTAL SCIENCES,
KRISHNA INSTITUTE OF MEDICAL SCIENCES
"DEEMED TO BE UNIVERSITY", KARAD-415539
INDIAN
8. Whether the work is published or unpublished : UNPUBLISHED
9. Year and country of first publication and name, address and nationality of the publisher : N.A.
10. Years and countries of subsequent publications, if any, and names, addresses and nationalities of the publishers : N.A.
11. Names, addresses and nationalities of the owners of various rights comprising the copyright in the work and the extent of rights held by each, together with particulars of assignments and licences, if any : KRISHNA INSTITUTE OF MEDICAL SCIENCES "DEEMED TO BE UNIVERSITY", KARAD , KRISHNA INSTITUTE OF MEDICAL SCIENCES "DEEMED TO BE UNIVERSITY", KARAD, MALKAPUR, KARAD, DIST. SATARA, MAHARASHTRA, INDIA-415539
INDIAN
12. Names, addresses and nationalities of other persons, if any, authorised to assign or licence of rights comprising the copyright : N.A.
13. If the work is an 'Artistic work', the location of the original work, including the address and nationality of the person in possession of the work, in the case of an architectural work, the year of construction (if any) should also be shown). : N.A.
14. If the work is a 'Work of Applied Art' which is used or capable of being used in goods or services, the application should be made to the Registrar of Trade Marks in terms of Section (i) of Section 45 of the Copyright Act, : N.A.
15. If the work is an 'Artistic work', whether it is registered under the Designs Act 2000 if yes give details. : N.A.
16. If the work is an 'Artistic work', capable of being registered as a design under the Designs Act 2000.whether it has been applied to an article though an industrial process and ,if yes ,the number of times it is reproduced. : N.A.
17. Remarks, if any :



DEPUTY REGISTRAR OF COPYRIGHTS

Diary Number : 838/2020-CO/L
Date of Application : 16/01/2020
Date of Receipt : 16/01/2020



A handwritten signature in blue ink, consisting of a stylized, cursive script.

DEPUTY REGISTRAR OF COPYRIGHTS



Dated : 13/07/2020

1. Registration Number : **L-92762/2020**
2. Name, address and nationality of the applicant : KRISHNA INSTITUTE OF MEDICAL SCIENCES "DEEMED TO BE UNIVERSITY", KARAD , KRISHNA INSTITUTE OF MEDICAL SCIENCES "DEEMED TO BE UNIVERSITY", KARAD, MALKAPUR, KARAD, DIST. SATARA, MAHARASHTRA, INDIA-415539 INDIAN
3. Nature of the applicant's interest in the copyright of the work : OWNER
4. Class and description of the work : LITERARY/ DRAMATIC WORK USE OF GAMES FOR TEACHING AS WELL AS LEARNING IN DENTAL ACADEMICS
5. Title of the work : LEARNING AID IN TEACHING LEARNING OF DENTAL SCIENCE - A GAME BASED APPROACH
6. Language of the work : ENGLISH
7. Name, address and nationality of the author and if the author is deceased, date of his decease : DR. SUSHMA BOMMANAVAR , ORAL PATHOLOGY, KRISHNA INSTITUTE OF MEDICAL SCIENCES DEEMED TO BE UNIVERSITY, KARAD, MALKAPUR, KARAD, DIST. SATARA-415539 INDIAN
8. Whether the work is published or unpublished : UNPUBLISHED
9. Year and country of first publication and name, address and nationality of the publisher : N.A.
10. Years and countries of subsequent publications, if any, and names, addresses and nationalities of the publishers : N.A.
11. Names, addresses and nationalities of the owners of various rights comprising the copyright in the work and the extent of rights held by each, together with particulars of assignments and licences, if any : KRISHNA INSTITUTE OF MEDICAL SCIENCES "DEEMED TO BE UNIVERSITY", KARAD , KRISHNA INSTITUTE OF MEDICAL SCIENCES "DEEMED TO BE UNIVERSITY", KARAD, MALKAPUR, KARAD, DIST. SATARA, MAHARASHTRA, INDIA-415539 INDIAN
12. Names, addresses and nationalities of other persons, if any, authorised to assign or licence of rights comprising the copyright : N.A.
13. If the work is an 'Artistic work', the location of the original work, including name, address and nationality of the person in possession of the work. (In the case of an architectural work, the year of completion of the work should also be shown). : N.A.
14. If the work is an 'Artistic work' which is used or capable of being used in relation to any goods or services, the application should include a certification from the Registrar of Trade Marks in terms of the provision to Sub-Section (i) of Section 45 of the Copyright Act, 1957. : N.A.
15. If the work is an 'Artistic work', whether it is registered under the Designs Act 2000 if yes give details. : N.A.
16. If the work is an 'Artistic work', capable of being registered as a design under the Designs Act 2000, whether it has been applied to an article though an industrial process and ,if yes ,the number of times it is reproduced. : N.A.
17. Remarks :



7092/2020-CO/L

29/05/2020

29/05/2020

DEPUTY REGISTRAR OF COPYRIGHTS

Dated : 28/07/2020

1. Registration Number : **CF-4629/2020**
2. Name, address and nationality of the applicant : KRISHNA INSTITUTE OF MEDICAL SCIENCES "DEEMED TO BE UNIVERSITY", KARAD , NH4, PUNE - BANGALORE HIGHWAY, DIST.SATARA, AGASHIVNAGAR, MALKAPUR, MAHARASHTRA-415539 INDIAN
3. Nature of the applicant's interest in the copyright of the work : OWNER
4. Class and description of the work : CINEMATOGRAPH FILM WORK
5. Title of the work : ZEBRA CROSSING - DEPICTING MEASURES FOR PREVENTION OF ROAD TRAFFIC ACCIDENTS (FORENSIC MEDICINE)
6. Language of the work : ENGLISH
7. Name, address and nationality of the author and if the author is deceased, date of his decease : DR AJAY VINAYAK PATIL , NH4, PUNE - BANGALORE HIGHWAY, DIST.SATARA, AGASHIVNAGAR, MALKAPUR, MAHARASHTRA-415539 INDIAN
 DR CHANDRAKANT M. KOKATANUR , NH4, PUNE - BANGALORE HIGHWAY, DIST.SATARA, AGASHIVNAGAR, MALKAPUR, MAHARASHTRA-415539 INDIAN
 DR VINAY BANNUR , NH4, PUNE - BANGALORE HIGHWAY, DIST.SATARA, AGASHIVNAGAR, MALKAPUR, MAHARASHTRA-415539 INDIAN
 UMANSHI LAL , NH4, PUNE - BANGALORE HIGHWAY, DIST.SATARA, AGASHIVNAGAR, MALKAPUR, MAHARASHTRA-415539 INDIAN
 TWINKLE DAHIA , NH4, PUNE - BANGALORE HIGHWAY, DIST.SATARA, AGASHIVNAGAR, MALKAPUR, MAHARASHTRA-415539 INDIAN
 NAZREEN FATMA , NH4, PUNE - BANGALORE HIGHWAY, DIST.SATARA, AGASHIVNAGAR, MALKAPUR, MAHARASHTRA-415539 INDIAN
8. Whether the work is published or unpublished : UNPUBLISHED
9. Year and country of first publication and name, address and nationality of the publisher : N.A.
10. Years and countries of subsequent publications, if any, and names, addresses and nationalities of the publishers : N.A.
11. Names, addresses and nationalities of the owners of various rights comprising the copyright in the work and the extent of rights held by each, together with particulars of assignments and licences, if any : KRISHNA INSTITUTE OF MEDICAL SCIENCES "DEEMED TO BE UNIVERSITY", KARAD , NH4, PUNE - BANGALORE HIGHWAY, DIST.SATARA, AGASHIVNAGAR, MALKAPUR, MAHARASHTRA-415539 INDIAN
12. Names, addresses and nationalities of other persons, if any, authorised to assign or licence of rights comprising the copyright : KRISHNA INSTITUTE OF MEDICAL SCIENCES "DEEMED TO BE UNIVERSITY", KARAD , NH4, PUNE - BANGALORE HIGHWAY, DIST.SATARA, AGASHIVNAGAR, MALKAPUR, MAHARASHTRA-415539 INDIAN

13. If the work is an 'Artistic work', the location of the original work, including name, address and nationality of the person in possession of the work. (In the case of an architectural work, the year of completion of the work should also be shown). : N.A.
14. If the work is an 'Artistic work' which is used or capable of being used in relation to any goods or services, the application should include a certification from the Registrar of Trade Marks in terms of the provision to Sub-Section (1) of Section 45 of the Copyright Act, 1957 : N.A.
15. If the work is an 'Artistic work', whether it is registered under the Designs Act 2000 if yes give details. : N.A.
16. If the work is an 'Artistic work', capable of being registered as a design under the Designs Act 2000, whether it has been applied to an article through an industrial process and, if yes, the number of times it is reproduced. : N.A.
17. Remarks, if any

Diary Number : 4180/2020-CO/CF
Date of Application : 05/03/2020
Date of Receipt : 05/03/2020

DEPUTY REGISTRAR OF COPYRIGHTS



Dated : 28/07/2020

1. Registration Number : **CF-4630/2020**
2. Name, address and nationality of the applicant : KRISHNA INSTITUTE OF MEDICAL SCIENCES "DEEMED TO BE UNIVERSITY", KARAD , NH4, PUNE - BANGALORE HIGHWAY, DIST.SATARA, AGASHIVNAGAR, MALKAPUR, MAHARASHTRA-415539 INDIAN
3. Nature of the applicant's interest in the copyright of the work : OWNER
4. Class and description of the work : CINEMATOGRAPH FILM WORK
5. Title of the work : DO NOT 'DRINK & DRIVE' (ALCOHOLIC DRINKS) & ALWAYS WEAR A SEATBELT- ANIMATED VIDEO DEPICTING MEASURES FOR PREVENTION OF ROAD TRAFFIC ACCIDENTS
6. Language of the work : ENGLISH
7. Name, address and nationality of the author and if the author is deceased, date of his decease : DR. CHANDRAKANT M KOKATANUR , NH4, PUNE - BANGALORE HIGHWAY, DIST.SATARA, AGASHIVNAGAR, MALKAPUR, MAHARASHTRA-415539 INDIAN
DR AJAY V PATIL , NH4, PUNE - BANGALORE HIGHWAY, DIST.SATARA, AGASHIVNAGAR, MALKAPUR, MAHARASHTRA-415539 INDIAN
DR VINAY BANNUR , NH4, PUNE - BANGALORE HIGHWAY, DIST.SATARA, AGASHIVNAGAR, MALKAPUR, MAHARASHTRA-415539 INDIAN
TANYA VOHRA , NH4, PUNE - BANGALORE HIGHWAY, DIST.SATARA, AGASHIVNAGAR, MALKAPUR, MAHARASHTRA-415539 INDIAN
NAZREEN FATEMA , NH4, PUNE - BANGALORE HIGHWAY, DIST.SATARA, AGASHIVNAGAR, MALKAPUR, MAHARASHTRA-415539 INDIAN
8. Whether the work is published or unpublished : UNPUBLISHED
9. Year and country of first publication and name, address and nationality of the publisher : N.A.
10. Years and countries of subsequent publications, if any, and names, addresses and nationalities of the publishers : N.A.
11. Names, addresses and nationalities of the owners of various rights comprising the copyright in the work and the extent of rights held by each, together with particulars of assignments and licences, if any : KRISHNA INSTITUTE OF MEDICAL SCIENCES "DEEMED TO BE UNIVERSITY", KARAD , NH4, PUNE - BANGALORE HIGHWAY, DIST.SATARA, AGASHIVNAGAR, MALKAPUR, MAHARASHTRA-415539 INDIAN
12. Names, addresses and nationalities of other persons, if any, authorised to assign or licence of rights comprising the copyright : KRISHNA INSTITUTE OF MEDICAL SCIENCES "DEEMED TO BE UNIVERSITY", KARAD , NH4, PUNE - BANGALORE HIGHWAY, DIST.SATARA, AGASHIVNAGAR, MALKAPUR, MAHARASHTRA-415539 INDIAN

- 13. If the work is an 'Artistic work', the location of the original work, including name, address and nationality of the person in possession of the work. (In the case of an architectural work, the year of completion of the work should also be shown). : N.A.
- 14. If the work is an 'Artistic work' which is used or capable of being used in relation to any goods or services, the application should include a certification from the Registrar of Trade Marks in terms of the provision to Sub-Section (i) of Section 45 of the Copyright Act, 1957 : N.A.
- 15. If the work is an 'Artistic work', whether it is registered under the Designs Act 2000 if yes give details. : N.A.
- 16. If the work is an 'Artistic work', capable of being registered as a design under the Designs Act 2000, whether it has been applied to an article though an industrial process and, if yes, the number of times it is reproduced. : N.A.
- 17. Remarks, if any :

Diary Number : 4086/2020-CO/CF
 Date of Application : 04/03/2020
 Date of Receipt : 04/03/2020

 DEPUTY REGISTRAR OF COPYRIGHTS

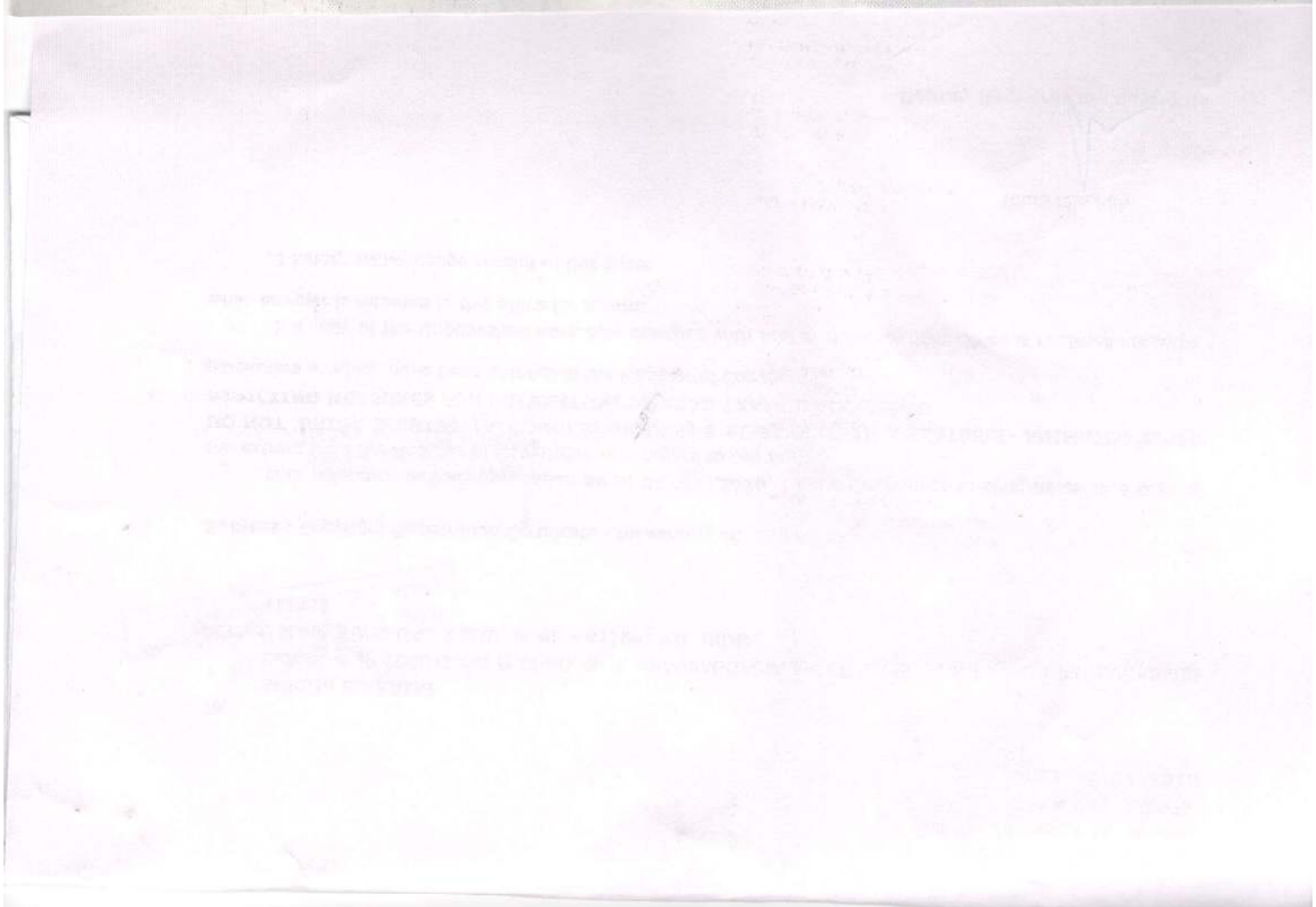
Dated : 28/07/2020

1. Registration Number : **CF-4628/2020**
2. Name, address and nationality of the applicant : KRISHNA INSTITUTE OF MEDICAL SCIENCES "DEEMED TO BE UNIVERSITY", KARAD , NH4, PUNE - BANGALORE HIGHWAY, DIST.SATARA, AGASHIVNAGAR, MALKAPUR, MAHARASHTRA-415539 INDIAN
3. Nature of the applicant's interest in the copyright of the work : OWNER
4. Class and description of the work : CINEMATOGRAPH FILM WORK
5. Title of the work : DO NOT USE COMMUNICATION DEVICES WHEN TRAVELLING ON ROAD - DEPICTING MEASURES FOR PREVENTION OF ROAD TRAFFIC ACCIDENTS
6. Language of the work : ENGLISH
7. Name, address and nationality of the author and if the author is deceased, date of his decease : DR AJAY VINAYAK PATIL , NH4, PUNE - BANGALORE HIGHWAY, DIST.SATARA, AGASHIVNAGAR, MALKAPUR, MAHARASHTRA-415539 INDIAN
DR CHANDRAKANT M. KOKATANUR , NH4, PUNE - BANGALORE HIGHWAY, DIST.SATARA, AGASHIVNAGAR, MALKAPUR, MAHARASHTRA-415539 INDIAN
DR VINAY BANNUR , NH4, PUNE - BANGALORE HIGHWAY, DIST.SATARA, AGASHIVNAGAR, MALKAPUR, MAHARASHTRA-415539 INDIAN
VAISHNAV SETHUMADHAVAN , NH4, PUNE - BANGALORE HIGHWAY, DIST.SATARA, AGASHIVNAGAR, MALKAPUR, MAHARASHTRA-415539 INDIAN
VAISHALI AGGARWAL , NH4, PUNE - BANGALORE HIGHWAY, DIST.SATARA, AGASHIVNAGAR, MALKAPUR, MAHARASHTRA-415539 INDIAN
NAZREEN FATMA , NH4, PUNE - BANGALORE HIGHWAY, DIST.SATARA, AGASHIVNAGAR, MALKAPUR, MAHARASHTRA-415539 INDIAN
8. Whether the work is published or unpublished : UNPUBLISHED
9. Year and country of first publication and name, address and nationality of the publisher : N.A.
10. Years and countries of subsequent publications, if any, and names, addresses and nationalities of the publishers : N.A.
11. Names, addresses and nationalities of the owners of various rights comprising the copyright in the work and the extent of rights held by each, together with particulars of assignments and licences, if any : KRISHNA INSTITUTE OF MEDICAL SCIENCES "DEEMED TO BE UNIVERSITY", KARAD , NH4, PUNE - BANGALORE HIGHWAY, DIST.SATARA, AGASHIVNAGAR, MALKAPUR, MAHARASHTRA-415539 INDIAN
12. Names, addresses and nationalities of other persons, if any, authorised to assign or licence of rights comprising the copyright : KRISHNA INSTITUTE OF MEDICAL SCIENCES "DEEMED TO BE UNIVERSITY", KARAD , NH4, PUNE - BANGALORE HIGHWAY, DIST.SATARA, AGASHIVNAGAR, MALKAPUR, MAHARASHTRA-415539 INDIAN
13. If the work is an 'Artistic work', the location of the original work, including name, address and nationality of the person in possession of the work. (In the case of an architectural work, the year of completion of the work should also be shown). : N.A.

14. If the work is an 'Artistic work' which is used or capable of being used in relation to any goods or services, the application should include a certification from the Registrar of Trade Marks in terms of the provision to Sub-Section (i) of Section 45 of the Copyright Act, 1957 : N.A.
15. If the work is an 'Artistic work', whether it is registered under the Designs Act 2000 if yes give details. : N.A.
16. If the work is an 'Artistic work', capable of being registered as a design under the Designs Act 2000, whether it has been applied to an article through an industrial process and, if yes, the number of times it is reproduced. : N.A.
17. Remarks, if any

Diary Number : 4178/2020-CO/CF
Date of Application : 05/03/2020
Date of Receipt : 05/03/2020

DEPUTY REGISTRAR OF COPYRIGHTS





Dated : 14/08/2020

1. Registration Number : **L-93617/2020**
2. Name, address and nationality of the applicant : KRISHNA INSTITUTE OF MEDICAL SCIENCES "DEEMED TO BE UNIVERSITY", KARAD , NH4, PUNE - BANGALORE HIGHWAY, DIST.SATARA, AGASHIVNAGAR, MALKAPUR, MAHARASHTRA-415539 INDIAN
3. Nature of the applicant's interest in the copyright of the work : OWNER
4. Class and description of the work : LITERARY/ DRAMATIC WORK
5. Title of the work : PROCESS FLOW FOR DIRECT COMPRESSION PROCESS
6. Language of the work : ENGLISH
7. Name, address and nationality of the author and if the author is deceased, date of his decease : DR. ROHIT RAJENDRA BHOSALE , KRISHNA INSTITUTE OF MEDICAL SCIENCES DEEMED TO BE UNIVERSITY, NH4, PUNE - BANGALORE HIGHWAY, DIST.SATARA, AGASHIVNAGAR, MALKAPUR, MAHARASHTRA-415539-415539 INDIAN
DR. RAJENDRA C. DOJAD , KRISHNA INSTITUTE OF MEDICAL SCIENCES DEEMED TO BE UNIVERSITY, NH4, PUNE - BANGALORE HIGHWAY, DIST.SATARA, AGASHIVNAGAR, MALKAPUR, MAHARASHTRA-415539 INDIAN
8. Whether the work is published or unpublished : UNPUBLISHED
9. Year and country of first publication and name, address and nationality of the publisher : N.A.
10. Years and countries of subsequent publications, if any, and names, addresses and nationalities of the publishers : N.A.
11. Names, addresses and nationalities of the owners of various rights comprising the copyright in the work and the extent of rights held by each, together with particulars of assignments and licences, if any : KRISHNA INSTITUTE OF MEDICAL SCIENCES "DEEMED TO BE UNIVERSITY", KARAD , NH4, PUNE - BANGALORE HIGHWAY, DIST.SATARA, AGASHIVNAGAR, MALKAPUR, MAHARASHTRA-415539 INDIAN
12. Names, addresses and nationalities of other persons, if any, authorised to assign or licence of rights comprising the copyright : KRISHNA INSTITUTE OF MEDICAL SCIENCES "DEEMED TO BE UNIVERSITY", KARAD , NH4, PUNE - BANGALORE HIGHWAY, DIST.SATARA, AGASHIVNAGAR, MALKAPUR, MAHARASHTRA-415539 INDIAN
13. If the work is an 'Artistic work', the location of the original work, including name, address and nationality of the person in possession of the work. (In the case of an architectural work, the year of completion of the work should also be shown). : N.A.
14. If the work is an 'Artistic work' which is used or capable of being used in relation to any goods or services, the application should include a certification from the Registrar of Trade Marks in terms of the provision to Sub-Section (i) of Section 45 of the Copyright Act, 1957. : N.A.
15. If the work is an 'Artistic work', whether it is registered under the Designs Act 2000 if yes give details. : N.A.
16. If the work is an 'Artistic work', capable of being registered as a design under the Designs Act 2000, whether it has been applied to an article, if yes, the number of times : N.A.
17. :



7995/2020-CO/L

17/06/2020

Date of registration : 17/06/2020

DEPUTY REGISTRAR OF COPYRIGHTS



Dated : 20/08/2020

1. Registration Number : **L-93890/2020**
2. Name, address and nationality of the applicant : KRISHNA INSTITUTE OF MEDICAL SCIENCES "DEEMED TO BE UNIVERSITY", KARAD ADDRESS , NH4, PUNE - BANGALORE HIGHWAY, DIST.SATARA, AGASHIVNAGAR, MALKAPUR, MAHARASHTRA-415539 INDIAN
3. Nature of the applicant's interest in the copyright of the work : OWNER
4. Class and description of the work : LITERARY/ DRAMATIC WORK
5. Title of the work : PROCESS FLOW FOR DRY GRANULATION PROCESS
6. Language of the work : ENGLISH
7. Name, address and nationality of the author and if the author is deceased, date of his decease : DR. ROHIT RAJENDRA BHOSALE , DEPARTMENT OF PHARMACEUTICS, KRISHNA INSTITUTE OF MEDICAL SCIENCES DEEMED TO BE UNIVERSITY, NH4, PUNE - BANGALORE HIGHWAY, DIST.SATARA, AGASHIVNAGAR, MALKAPUR, MAHARASHTRA-415539-415539 INDIAN
DR. RAJENDRA C. DOIJAD , DEPARTMENT OF PHARMACEUTICS, KRISHNA INSTITUTE OF MEDICAL SCIENCES DEEMED TO BE UNIVERSITY, NH4, PUNE - BANGALORE HIGHWAY, DIST.SATARA, AGASHIVNAGAR, MALKAPUR, MAHARASHTRA-415539 INDIAN
8. Whether the work is published or unpublished : UNPUBLISHED
9. Year and country of first publication and name, address and nationality of the publisher : N.A.
10. Years and countries of subsequent publications, if any, and names, addresses and nationalities of the publishers : N.A.
11. Names, addresses and nationalities of the owners of various rights comprising the copyright in the work and the extent of rights held by each, together with particulars of assignments and licences, if any : KRISHNA INSTITUTE OF MEDICAL SCIENCES "DEEMED TO BE UNIVERSITY", KARAD ADDRESS , NH4, PUNE - BANGALORE HIGHWAY, DIST.SATARA, AGASHIVNAGAR, MALKAPUR, MAHARASHTRA-415539 INDIAN
12. Names, addresses and nationalities of other persons, if any, authorised to assign or licence of rights comprising the copyright : KRISHNA INSTITUTE OF MEDICAL SCIENCES "DEEMED TO BE UNIVERSITY", KARAD ADDRESS , NH4, PUNE - BANGALORE HIGHWAY, DIST.SATARA, AGASHIVNAGAR, MALKAPUR, MAHARASHTRA-415539 INDIAN
13. If the work is an 'Artistic work', the location of the original work, including name, address and nationality of the person in possession of the work. (In the case of an architectural work, the year of completion of the work should also be shown). : N.A.
14. If the work is an 'Artistic work' which is used or capable of being used in relation to any goods or services, the application should include a certification from the Registrar of Trade Marks in terms of the provision to Sub-Section (i) of Section 45 of the Copyright Act, 1957. : N.A.
15. If the work is an 'Artistic work', whether it is registered under the : N.A.
as give details.
16. If the work is an 'Artistic work', capable of being registered as a : N.A.
s Act 2000.whether it has been applied to an
rial process and ,if yes ,the number of times
17. Re :
DEPUTY REGISTRAR OF COPYRIGHTS

Diary Number : 8094/2020-CO/L
Date of Application : 18/06/2020
Date of Receipt : 18/06/2020



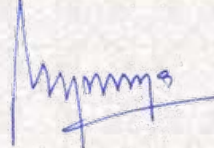



Dated : 20/08/2020

1. Registration Number : **L-93891/2020**
2. Name, address and nationality of the applicant : KRISHNA INSTITUTE OF MEDICAL SCIENCES "DEEMED TO BE UNIVERSITY", KARAD , NH4, PUNE - BANGALORE HIGHWAY, DIST.SATARA, AGASHIVNAGAR, MALKAPUR, MAHARASHTRA-415539 INDIAN
3. Nature of the applicant's interest in the copyright of the work : OWNER
4. Class and description of the work : LITERARY/ DRAMATIC WORK
5. Title of the work : PROCESS FLOW FOR WET GRANULATION PROCESS
6. Language of the work : ENGLISH
7. Name, address and nationality of the author and if the author is deceased, date of his decease : DR. ROHIT RAJENDRA BHOSALE , DEPARTMENT OF PHARMACEUTICS, KRISHNA INSTITUTE OF MEDICAL SCIENCES "DEEMED TO BE UNIVERSITY", KARAD, NH4, PUNE - BANGALORE HIGHWAY, DIST.SATARA, AGASHIVNAGAR, MALKAPUR, MAHARASHTRA-415539 INDIAN
DR. RAJENDRA C. DOIJAD , DEPARTMENT OF PHARMACEUTICS, KRISHNA INSTITUTE OF MEDICAL SCIENCES "DEEMED TO BE UNIVERSITY", KARAD, NH4, PUNE - BANGALORE HIGHWAY, DIST.SATARA, AGASHIVNAGAR, MALKAPUR, MAHARASHTRA-415539 INDIAN
8. Whether the work is published or unpublished : UNPUBLISHED
9. Year and country of first publication and name, address and nationality of the publisher : N.A.
10. Years and countries of subsequent publications, if any, and names, addresses and nationalities of the publishers : N.A.
11. Names, addresses and nationalities of the owners of various rights comprising the copyright in the work and the extent of rights held by each, together with particulars of assignments and licences, if any : KRISHNA INSTITUTE OF MEDICAL SCIENCES "DEEMED TO BE UNIVERSITY", KARAD , NH4, PUNE - BANGALORE HIGHWAY, DIST.SATARA, AGASHIVNAGAR, MALKAPUR, MAHARASHTRA-415539 INDIAN
12. Names, addresses and nationalities of other persons, if any, authorised to assign or licence of rights comprising the copyright : KRISHNA INSTITUTE OF MEDICAL SCIENCES "DEEMED TO BE UNIVERSITY", KARAD , NH4, PUNE - BANGALORE HIGHWAY, DIST.SATARA, AGASHIVNAGAR, MALKAPUR, MAHARASHTRA-415539 INDIAN
13. If the work is an 'Artistic work', the location of the original work, including name, address and nationality of the person in possession of the work. (In the case of an architectural work, the year of completion of the work should also be shown). : N.A.
14. If the work is an 'Artistic work' which is used or capable of being used in relation to any goods or services, the application should include a certification from the Registrar of Trade Marks in terms of the provision to Sub-Section (i) of Section 45 of the Copyright Act, 1957. : N.A.
15. If the work is an 'Artistic work', whether it is registered under the Copyright Act, 1957, give details. : N.A.
16. If the work is an 'Artistic work', capable of being registered as a trademark under the Trade Marks Act 2000, whether it has been applied to an article, the date of application, the goods, if any, to which it has been applied, and, if yes, the number of times it has been applied. : N.A.
17. : N.A.



DEPUTY REGISTRAR OF COPYRIGHTS

Diary : 8102/2020-CO/L
Date of Application : 18/06/2020
Date of Receipt : 18/06/2020



Dated : 14/08/2020

1. Registration Number : **L-93607/2020**
2. Name, address and nationality of the applicant : KRISHNA INSTITUTE OF MEDICAL SCIENCES "DEEMED TO BE UNIVERSITY", KARAD , NH4, PUNE - BANGALORE HIGHWAY, DIST.SATARA, AGASHIVNAGAR, MALKAPUR, MAHARASHTRA-415539 INDIAN
3. Nature of the applicant's interest in the copyright of the work : OWNER
4. Class and description of the work : LITERARY/ DRAMATIC WORK
5. Title of the work : A NOVEL BIOCOMPATIBLE TECHNIQUE FOR ATTACHING CHEEK PLUMPER TO THE DENTURE (USING ERICH ARCH BAR)
6. Language of the work : ENGLISH
7. Name, address and nationality of the author and if the author is deceased, date of his decease : DR. SNEHA SHETTY , SCHOOL OF DENTAL SCIENCES, KRISHNA INSTITUTE OF MEDICAL SCIENCES "DEEMED TO BE UNIVERSITY", KARAD, NH4, PUNE - BANGALORE HIGHWAY, DIST.SATARA, AGASHIVNAGAR, MALKAPUR, MAHARASHTRA-415539 INDIAN
DR.BHAVNA AHUJA , SCHOOL OF DENTAL SCIENCES, KRISHNA INSTITUTE OF MEDICAL SCIENCES "DEEMED TO BE UNIVERSITY", KARAD, NH4, PUNE - BANGALORE HIGHWAY, DIST.SATARA, AGASHIVNAGAR, MALKAPUR, MAHARASHTRA-415539 INDIAN
DR. PRONOB SANYAL , SCHOOL OF DENTAL SCIENCES, KRISHNA INSTITUTE OF MEDICAL SCIENCES "DEEMED TO BE UNIVERSITY", KARAD, NH4, PUNE - BANGALORE HIGHWAY, DIST.SATARA, AGASHIVNAGAR, MALKAPUR, MAHARASHTRA-415539 INDIAN
8. Whether the work is published or unpublished : UNPUBLISHED
9. Year and country of first publication and name, address and nationality of the publisher : N.A.
10. Years and countries of subsequent publications, if any, and names, addresses and nationalities of the publishers : N.A.
11. Names, addresses and nationalities of the owners of various rights comprising the copyright in the work and the extent of rights held by each, together with particulars of assignments and licences, if any : KRISHNA INSTITUTE OF MEDICAL SCIENCES "DEEMED TO BE UNIVERSITY", KARAD , NH4, PUNE - BANGALORE HIGHWAY, DIST.SATARA, AGASHIVNAGAR, MALKAPUR, MAHARASHTRA-415539 INDIAN
12. Names, addresses and nationalities of other persons, if any, authorised to assign or licence of rights comprising the copyright : KRISHNA INSTITUTE OF MEDICAL SCIENCES "DEEMED TO BE UNIVERSITY", KARAD , NH4, PUNE - BANGALORE HIGHWAY, DIST.SATARA, AGASHIVNAGAR, MALKAPUR, MAHARASHTRA-415539 INDIAN
13. If the work is an 'Artistic work', the location of the original work, including name, address and nationality of the person in possession of the work. (In the case of an architectural work, the year of completion of the work should also be shown). : N.A.
14. If the work is an 'Artistic work' which is used or capable of being used in connection with goods or services, the application should be made to the Registrar of Trade Marks in terms of Section 17(1) of Section 45 of the Copyright Act, 1957. : N.A.
15. If the work is an 'Artistic work', whether it is registered under the Designs Act 2000, give details. : N.A.
16. If the work is an 'Artistic work', capable of being registered as a design under the Designs Act 2000, whether it has been applied to an article though an industrial process and, if yes, the number of times it is reproduced. : N.A.
17. Remarks, if any :



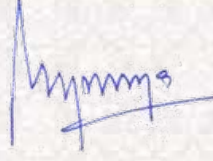

DEPUTY REGISTRAR OF COPYRIGHTS

Date of Application :

16/06/2020

Date of Receipt :

16/06/2020



A handwritten signature in blue ink, appearing to read "M. M. M. S.", is written over a faint rectangular stamp.

DEPUTY REGISTRAR OF COPYRIGHTS



Dated : 13/08/2020

1. Registration Number : **L-93493/2020**
2. Name, address and nationality of the applicant : KRISHNA INSTITUTE OF MEDICAL SCIENCES "DEEMED TO BE UNIVERSITY", KARAD , KRISHNA INSTITUTE OF MEDICAL SCIENCES "DEEMED TO BE UNIVERSITY", KARAD, MALKAPUR KARAD, DIST. SATARA, MAHARASHTRA, INDIA-415539 INDIAN
3. Nature of the applicant's interest in the copyright of the work : OWNER
4. Class and description of the work : LITERARY/ DRAMATIC WORK THIS WORK RELATES TO NUTRITION IN PARTICULAR TO NOVEL DIETARY SUBSTITUTE FOR ANIMAL MILK AND EASY TO DIGEST PRECOOKED MIXTURE FOR COMPLEMENTARY FEEDS.
5. Title of the work : VEGETARIAN MAGIC MIX: SUBSTITUTE FOR ANIMAL MILK
6. Language of the work : ENGLISH
7. Name, address and nationality of the author and if the author is deceased, date of his decease : DR. ASHA KRISHNA PRATINIDHI , KRISHNA INSTITUTE OF MEDICAL SCIENCES "DEEMED TO BE UNIVERSITY", KARAD, MALKAPUR KARAD, DIST. SATARA, MAHARASHTRA, INDIA-415539 INDIAN
MR. ANUP SUBHASH HENDRE , KRISHNA INSTITUTE OF MEDICAL SCIENCES "DEEMED TO BE UNIVERSITY", KARAD, MALKAPUR KARAD, DIST. SATARA, MAHARASHTRA, INDIA-415539 INDIAN
DR. SHILPA ADITYA PRATINIDHI , KRISHNA INSTITUTE OF MEDICAL SCIENCES "DEEMED TO BE UNIVERSITY", KARAD, MALKAPUR KARAD, DIST. SATARA, MAHARASHTRA, INDIA-415539 INDIAN
DR. VINAYAK YADAVRAO KSHIRSAGAR , KRISHNA INSTITUTE OF MEDICAL SCIENCES "DEEMED TO BE UNIVERSITY", KARAD, MALKAPUR KARAD, DIST. SATARA, MAHARASHTRA, INDIA-415539 INDIAN
DR. AJIT VASANTRAO SONTAKKE , KRISHNA INSTITUTE OF MEDICAL SCIENCES "DEEMED TO BE UNIVERSITY", KARAD, MALKAPUR KARAD, DIST. SATARA, MAHARASHTRA, INDIA-415539 INDIAN
8. Whether the work is published or unpublished : UNPUBLISHED
9. Year and country of first publication and name, address and nationality of the publisher : N.A.
10. Years and countries of subsequent publications, if any, and names, addresses and nationalities of the publishers : N.A.
11. Names, addresses and nationalities of the owners of various rights comprising the copyright in the work and the extent of rights held by each owner with particulars of assignments and licences, if any : KRISHNA INSTITUTE OF MEDICAL SCIENCES "DEEMED TO BE UNIVERSITY", KARAD , KRISHNA INSTITUTE OF MEDICAL SCIENCES "DEEMED TO BE UNIVERSITY", KARAD, MALKAPUR KARAD, DIST. SATARA, MAHARASHTRA, INDIA-415539 INDIAN
12. Names, addresses and nationalities of other persons, if any, who have been granted a licence of rights comprising the copyright : N.A.
13. If the work is an 'Artistic work', the location of the original work, including the name, address and nationality of the person in possession of the original work (in the case of an architectural work, the year of completion of the work should also be shown). : N.A.
14. If the work is an 'Artistic work' which is used or capable of being used in relation to any goods or services, the application should include a certification from the Registrar of Trade Marks in terms of the provision to Sub-Section (i) of Section 45 of the Copyright Act, 1957. : N.A.

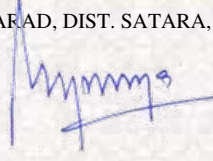

DEPUTY REGISTRAR OF COPYRIGHTS

15. If the work is an 'Artistic work', whether it is registered under the Designs Act 2000 if yes give details. : N.A.
16. If the work is an 'Artistic work', capable of being registered as a design under the Designs Act 2000.whether it has been applied to an article though an industrial process and ,if yes ,the number of times it is reproduced. : N.A.
17. Remarks, if any :
- Diary Number : 7558/2020-CO/L
- Date of Application : 09/06/2020
- Date of Receipt : 09/06/2020



A handwritten signature in blue ink, appearing to read 'M. M. M. S.', is written over a faint rectangular stamp.

DEPUTY REGISTRAR OF COPYRIGHTS



Dated : 13/08/2020

1. Registration Number : **L-93492/2020**
2. Name, address and nationality of the applicant : KRISHNA INSTITUTE OF MEDICAL SCIENCES "DEEMED TO BE UNIVERSITY", KARAD , KRISHNA INSTITUTE OF MEDICAL SCIENCES "DEEMED TO BE UNIVERSITY", KARAD, MALKAPUR KARAD, DIST. SATARA, MAHARASHTRA, INDIA-415539 INDIAN
3. Nature of the applicant's interest in the copyright of the work : OWNER
4. Class and description of the work : LITERARY/ DRAMATIC WORK THIS WORK IS IN THE FIELD OF BIOMEDICAL RESEARCH PARTICULARLY IN THE FIELD OF FOOD AND NUTRITION.
5. Title of the work : DIET SURVEY KIT FOR FAMILY DIET SURVEY OF UNCOOKED FOOD
6. Language of the work : ENGLISH
7. Name, address and nationality of the author and if the author is deceased, date of his decease : DR. ASHA KRISHNA PRATINIDHI , KRISHNA INSTITUTE OF MEDICAL SCIENCES "DEEMED TO BE UNIVERSITY", KARAD, MALKAPUR KARAD, DIST. SATARA, MAHARASHTRA, INDIA-415539 INDIAN
MR. ANUP SUBHASH HENDRE , KRISHNA INSTITUTE OF MEDICAL SCIENCES "DEEMED TO BE UNIVERSITY", KARAD, MALKAPUR KARAD, DIST. SATARA, MAHARASHTRA, INDIA-415539 INDIAN
DR. SHILPA ADITYA PRATINIDHI , MAHARASHTRA INSTITUTE OF MEDICAL EDUCATION & RESEARCH, TALEGAON DABHADE PUNE, MAHARASHTRA, INDIA-410507 INDIAN
DR. SATISH VASANT KAKADE , KRISHNA INSTITUTE OF MEDICAL SCIENCES "DEEMED TO BE UNIVERSITY", KARAD, MALKAPUR KARAD, DIST. SATARA, MAHARASHTRA, INDIA-415539 INDIAN
DR. AJIT VASANTRAO SONTAKKE , KRISHNA INSTITUTE OF MEDICAL SCIENCES "DEEMED TO BE UNIVERSITY", KARAD, MALKAPUR KARAD, DIST. SATARA, MAHARASHTRA, INDIA-415539 INDIAN
8. Whether the work is published or unpublished : UNPUBLISHED
9. Year and country of first publication and name, address and nationality of the publisher : N.A.
10. Years and countries of subsequent publications, if any, and names, addresses and nationalities of the publishers : N.A.
11. Names, addresses and nationalities of the owners of various rights comprising the copyright in the work and the extent of rights held by each owner with particulars of assignments and licences, if any : KRISHNA INSTITUTE OF MEDICAL SCIENCES "DEEMED TO BE UNIVERSITY", KARAD , KRISHNA INSTITUTE OF MEDICAL SCIENCES "DEEMED TO BE UNIVERSITY", KARAD, MALKAPUR KARAD, DIST. SATARA, MAHARASHTRA, INDIA-415539 INDIAN
12. Names, addresses and nationalities of other persons, if any, who have been granted a licence of rights comprising the copyright : N.A.
13. If the work is an 'Artistic work', the location of the original work, including the name, address and nationality of the person in possession of the work (in the case of an architectural work, the year of completion of the work should also be shown). : N.A.
14. If the work is an 'Artistic work' which is used or capable of being used in relation to any goods or services, the application should include a certification from the Registrar of Trade Marks in terms of the provision to Sub-Section (i) of Section 45 of the Copyright Act, 1957. : N.A.

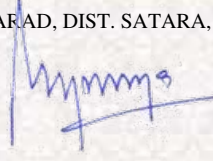

DEPUTY REGISTRAR OF COPYRIGHTS

15. If the work is an 'Artistic work', whether it is registered under the Designs Act 2000 if yes give details. : N.A.
16. If the work is an 'Artistic work', capable of being registered as a design under the Designs Act 2000.whether it has been applied to an article though an industrial process and ,if yes ,the number of times it is reproduced. : N.A.
17. Remarks, if any :
- Diary Number : 7562/2020-CO/L
- Date of Application : 09/06/2020
- Date of Receipt : 09/06/2020



A handwritten signature in blue ink, appearing to read 'M. M. M. S.', is written over a faint rectangular stamp.

DEPUTY REGISTRAR OF COPYRIGHTS



Dated : 28/08/2020

1. Registration Number : **L-94203/2020**
2. Name, address and nationality of the applicant : KRISHNA INSTITUTE OF MEDICAL SCIENCES "DEEMED TO BE UNIVERSITY", KARAD , NH4, PUNE - BANGALORE HIGHWAY, DIST.SATARA, AGASHIVNAGAR, MALKAPUR, MAHARASHTRA-415539 INDIAN
3. Nature of the applicant's interest in the copyright of the work : OWNER
4. Class and description of the work : LITERARY/ DRAMATIC WORK
5. Title of the work : FORENSIC MEDICINE AND TOXICOLOGY MOOT COURT 2020
6. Language of the work : ENGLISH
7. Name, address and nationality of the author and if the author is deceased, date of his decease : DR.CHANDRAKANT M KOKATANUR , NH4, PUNE - BANGALORE HIGHWAY, DIST.SATARA, AGASHIVNAGAR, MALKAPUR, MAHARASHTRA-415539 INDIAN
DR. AJAY PATIL , NH4, PUNE - BANGALORE HIGHWAY, DIST.SATARA, AGASHIVNAGAR, MALKAPUR, MAHARASHTRA-415539 INDIAN
DR. VINAY BANNUR , NH4, PUNE - BANGALORE HIGHWAY, DIST.SATARA, AGASHIVNAGAR, MALKAPUR, MAHARASHTRA-415539 INDIAN
DR. KAPIL M MORE , NH4, PUNE - BANGALORE HIGHWAY, DIST.SATARA, AGASHIVNAGAR, MALKAPUR, MAHARASHTRA-415539 INDIAN
8. Whether the work is published or unpublished : UNPUBLISHED
9. Year and country of first publication and name, address and nationality of the publisher : N.A.
10. Years and countries of subsequent publications, if any, and names, addresses and nationalities of the publishers : N.A.
11. Names, addresses and nationalities of the owners of various rights comprising the copyright in the work and the extent of rights held by each, together with particulars of assignments and licences, if any : KRISHNA INSTITUTE OF MEDICAL SCIENCES "DEEMED TO BE UNIVERSITY", KARAD , NH4, PUNE - BANGALORE HIGHWAY, DIST.SATARA, AGASHIVNAGAR, MALKAPUR, MAHARASHTRA-415539 INDIAN
12. Names, addresses and nationalities of other persons, if any, authorised to assign or licence of rights comprising the copyright : KRISHNA INSTITUTE OF MEDICAL SCIENCES "DEEMED TO BE UNIVERSITY", KARAD , NH4, PUNE - BANGALORE HIGHWAY, DIST.SATARA, AGASHIVNAGAR, MALKAPUR, MAHARASHTRA-415539 INDIAN
13. If the work is an 'Artistic work', the location of the original work, including name, address and nationality of the person in possession of the work. (In the case of an architectural work, the year of completion of the work should also be shown). : N.A.
14. If the work is an 'Artistic work' which is used or capable of being used in connection with goods or services, the application should be made to the Registrar of Trade Marks in terms of Section 45 of the Copyright Act, : N.A.
15. If the work is an 'Artistic work', whether it is registered under the Designs Act 2000, give details. : N.A.
16. If the work is an 'Artistic work', capable of being registered as a design under the Designs Act 2000, whether it has been applied to an article though an industrial process and, if yes, the number of times it is reproduced. : N.A.
17. Remarks, if any :



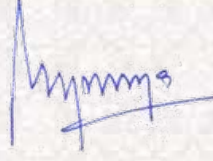

DEPUTY REGISTRAR OF COPYRIGHTS

Date of Application :

22/07/2020

Date of Receipt :

22/07/2020



A handwritten signature in blue ink, appearing to read "M. M. M. S.", is written over a faint rectangular stamp.

DEPUTY REGISTRAR OF COPYRIGHTS



Dated : 20/08/2020

1. Registration Number : **L-93900/2020**
2. Name, address and nationality of the applicant : KRISHNA INSTITUTE OF MEDICAL SCIENCES "DEEMED TO BE UNIVERSITY", KARAD , NH4, PUNE - BANGALORE HIGHWAY, DIST.SATARA, AGASHIVNAGAR, MALKAPUR, MAHARASHTRA-415539 INDIAN
3. Nature of the applicant's interest in the copyright of the work : OWNER
4. Class and description of the work : LITERARY/ DRAMATIC WORK
5. Title of the work : TEASER-MOOT COURT 2020
6. Language of the work : ENGLISH
7. Name, address and nationality of the author and if the author is deceased, date of his decease : DR. AJAY V. PATIL , KRISHNA INSTITUTE OF MEDICAL SCIENCES "DEEMED TO BE UNIVERSITY", KARAD, NH4, PUNE - BANGALORE HIGHWAY, DIST.SATARA, AGASHIVNAGAR, MALKAPUR, MAHARASHTRA-415539 INDIAN
DR. CHANDRAKANT M. KOKATANUR , KRISHNA INSTITUTE OF MEDICAL SCIENCES "DEEMED TO BE UNIVERSITY", KARAD, NH4, PUNE - BANGALORE HIGHWAY, DIST.SATARA, AGASHIVNAGAR, MALKAPUR, MAHARASHTRA-415539 INDIAN
DR. VINAY BANNUR , KRISHNA INSTITUTE OF MEDICAL SCIENCES "DEEMED TO BE UNIVERSITY", KARAD, NH4, PUNE - BANGALORE HIGHWAY, DIST.SATARA, AGASHIVNAGAR, MALKAPUR, MAHARASHTRA-415539 INDIAN
PRIYANSHU GUPTA , KRISHNA INSTITUTE OF MEDICAL SCIENCES "DEEMED TO BE UNIVERSITY", KARAD, NH4, PUNE - BANGALORE HIGHWAY, DIST.SATARA, AGASHIVNAGAR, MALKAPUR, MAHARASHTRA-415539 INDIAN
PRAFULL SINGHAL , KRISHNA INSTITUTE OF MEDICAL SCIENCES "DEEMED TO BE UNIVERSITY", KARAD, NH4, PUNE - BANGALORE HIGHWAY, DIST.SATARA, AGASHIVNAGAR, MALKAPUR, MAHARASHTRA-415539 INDIAN
8. Whether the work is published or unpublished : UNPUBLISHED
9. Year and country of first publication and name, address and nationality of the publisher : N.A.
10. Years and countries of subsequent publications, if any, and names, addresses and nationalities of the publishers : N.A.
11. Names, addresses and nationalities of the owners of various rights comprising the copyright in the work and the extent of rights held by each, together with particulars of assignments and licences, if any : KRISHNA INSTITUTE OF MEDICAL SCIENCES "DEEMED TO BE UNIVERSITY", KARAD , NH4, PUNE - BANGALORE HIGHWAY, DIST.SATARA, AGASHIVNAGAR, MALKAPUR, MAHARASHTRA-415539 INDIAN
12. Names, addresses and nationalities of other persons, if any, author or licence of rights comprising the copyright : KRISHNA INSTITUTE OF MEDICAL SCIENCES "DEEMED TO BE UNIVERSITY", KARAD , NH4, PUNE - BANGALORE HIGHWAY, DIST.SATARA, AGASHIVNAGAR, MALKAPUR, MAHARASHTRA-415539 INDIAN
13. If the work is an 'Artistic work', the location of the original work, and name and nationality of the person in possession of the work (in the case of an architectural work, the year of construction of the work should also be shown). : N.A.
14. If the work is an 'Artistic work' which is used or capable of being used in relation to any goods or services, the application should include a certification from the Registrar of Trade Marks in terms of the provision to Sub-Section (i) of Section 45 of the Copyright Act, 1957. : N.A.
15. If the work is an 'Artistic work', whether it is registered under the Designs Act 2000 if yes give details. : N.A.

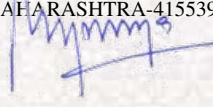

DEPUTY REGISTRAR OF COPYRIGHTS

16. If the work is an 'Artistic work', capable of being registered as a design under the Designs Act 2000, whether it has been applied to an article through an industrial process and, if yes, the number of times it is reproduced. : N.A.

17. Remarks, if any :

Diary Number : 8280/2020-CO/L

Date of Application : 22/06/2020

Date of Receipt : 22/06/2020



A handwritten signature in blue ink, appearing to read "M. M. M. S.", is written over a faint rectangular stamp.

DEPUTY REGISTRAR OF COPYRIGHTS



Dated : 27/07/2020

1. Registration Number : **L-93109/2020**
2. Name, address and nationality of the applicant : KRISHNA INSTITUTE OF MEDICAL SCIENCES "DEEMED TO BE UNIVERSITY", KARAD , NH4, PUNE - BANGALORE HIGHWAY, DIST.SATARA, AGASHIVNAGAR, MALKAPUR, MAHARASHTRA-415539 INDIAN
3. Nature of the applicant's interest in the copyright of the work : OWNER
4. Class and description of the work : LITERARY/ DRAMATIC WORK
5. Title of the work : GLANDERS:A RARE DISEASE
6. Language of the work : ENGLISH
7. Name, address and nationality of the author and if the author is deceased, date of his decease : DR. AMOL S. SHETE , KRISHNA INSTITUTE OF MEDICAL SCIENCES "DEEMED TO BE UNIVERSITY", KARAD NH4, PUNE - BANGALORE HIGHWAY, DIST.SATARA, AGASHIVNAGAR, MALKAPUR, MAHARASHTRA-415539-415539 INDIAN
DR. RAJENDRA C. DOIJAD , KRISHNA INSTITUTE OF MEDICAL SCIENCES "DEEMED TO BE UNIVERSITY", KARAD NH4, PUNE - BANGALORE HIGHWAY, DIST.SATARA, AGASHIVNAGAR, MALKAPUR, MAHARASHTRA-415539 INDIAN
8. Whether the work is published or unpublished : UNPUBLISHED
9. Year and country of first publication and name, address and nationality of the publisher : N.A.
10. Years and countries of subsequent publications, if any, and names, addresses and nationalities of the publishers : N.A.
11. Names, addresses and nationalities of the owners of various rights comprising the copyright in the work and the extent of rights held by each, together with particulars of assignments and licences, if any : KRISHNA INSTITUTE OF MEDICAL SCIENCES "DEEMED TO BE UNIVERSITY", KARAD , NH4, PUNE - BANGALORE HIGHWAY, DIST.SATARA, AGASHIVNAGAR, MALKAPUR, MAHARASHTRA-415539 INDIAN
12. Names, addresses and nationalities of other persons, if any, authorised to assign or licence of rights comprising the copyright : KRISHNA INSTITUTE OF MEDICAL SCIENCES "DEEMED TO BE UNIVERSITY", KARAD , NH4, PUNE - BANGALORE HIGHWAY, DIST.SATARA, AGASHIVNAGAR, MALKAPUR, MAHARASHTRA-415539 INDIAN
13. If the work is an 'Artistic work', the location of the original work, including name, address and nationality of the person in possession of the work. (In the case of an architectural work, the year of completion of the work should also be shown). : N.A.
14. If the work is an 'Artistic work' which is used or capable of being used in relation to any goods or services, the application should include a certification from the Registrar of Trade Marks in terms of the provision to Sub-Section (i) of Section 45 of the Copyright Act, 1957. : N.A.
15. If the work is an 'Artistic work', whether it is registered under the Copyright Act, 1957, give details. : N.A.
16. If the work is an 'Artistic work', capable of being registered as a trademark, whether it has been applied to an article, the date of application, if any, and the number of times it has been applied. : N.A.
17. If the work is an 'Artistic work', whether it is registered under the Copyright Act, 1957, give details. : N.A.



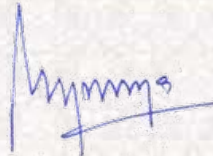

DEPUTY REGISTRAR OF COPYRIGHTS

Diary : 7801/2020-CO/L
Date of Application : 13/06/2020
Date of Receipt : 13/06/2020



Dated : 28/07/2020

1. Registration Number : **L-93135/2020**
2. Name, address and nationality of the applicant : KRISHNA INSTITUTE OF MEDICAL SCIENCES "DEEMED TO BE UNIVERSITY", KARAD , NH4, PUNE - BANGALORE HIGHWAY, DIST.SATARA, AGASHIVNAGAR, MALKAPUR, MAHARASHTRA-415539 INDIAN
3. Nature of the applicant's interest in the copyright of the work : OWNER
4. Class and description of the work : LITERARY/ DRAMATIC WORK
5. Title of the work : CREATING HANDOUTS INCORPORATING DESIGN, STRUCTURE, CONTENT, LOOK & FEEL IN PRINT MEDIA FOR MOOT COURT 2020
6. Language of the work : ENGLISH
7. Name, address and nationality of the author and if the author is deceased, date of his decease : DR AJAY VINAYAK PATIL , DEPARTMENT OF FORENSIC MEDICINE & TOXICOLOGY, KRISHNA INSTITUTE OF MEDICAL SCIENCES "DEEMED TO BE UNIVERSITY, KARAD. NH4, PUNE - BANGALORE HIGHWAY, DIST.SATARA, AGASHIVNAGAR, MALKAPUR, MAHARASHTRA-415539 INDIAN
DR CHANDRAKANT M. KOKATANUR , DEPARTMENT OF FORENSIC MEDICINE & TOXICOLOGY, KRISHNA INSTITUTE OF MEDICAL SCIENCES "DEEMED TO BE UNIVERSITY, KARAD. NH4, PUNE - BANGALORE HIGHWAY, DIST.SATARA, AGASHIVNAGAR, MALKAPUR, MAHARASHTRA-415539 INDIAN
DR VINAY BANNUR , DEPARTMENT OF FORENSIC MEDICINE & TOXICOLOGY, KRISHNA INSTITUTE OF MEDICAL SCIENCES "DEEMED TO BE UNIVERSITY, KARAD. NH4, PUNE - BANGALORE HIGHWAY, DIST.SATARA, AGASHIVNAGAR, MALKAPUR, MAHARASHTRA-415539 INDIAN
PRIYANSHU GUPTA , DEPARTMENT OF FORENSIC MEDICINE & TOXICOLOGY, KRISHNA INSTITUTE OF MEDICAL SCIENCES "DEEMED TO BE UNIVERSITY, KARAD. NH4, PUNE - BANGALORE HIGHWAY, DIST.SATARA, AGASHIVNAGAR, MALKAPUR, MAHARASHTRA-415539 INDIAN
PRAFULL SINGHAL , DEPARTMENT OF FORENSIC MEDICINE & TOXICOLOGY, KRISHNA INSTITUTE OF MEDICAL SCIENCES "DEEMED TO BE UNIVERSITY, KARAD. NH4, PUNE - BANGALORE HIGHWAY, DIST.SATARA, AGASHIVNAGAR, MALKAPUR, MAHARASHTRA-415539 INDIAN
8. Whether the work is published or unpublished : UNPUBLISHED
9. Year and country of first publication and name, address and nationality of the publisher : N.A.
10. Year and country of subsequent publications, if any, and names, addresses and nationalities of the publishers : N.A.
11. Nationalities of the owners of various rights in the work and the extent of rights held by them and particulars of assignments and licences, if any : KRISHNA INSTITUTE OF MEDICAL SCIENCES "DEEMED TO BE UNIVERSITY", KARAD , NH4, PUNE - BANGALORE HIGHWAY, DIST.SATARA, AGASHIVNAGAR, MALKAPUR, MAHARASHTRA-415539 INDIAN
12. Name, addresses and nationalities of other persons, if any, authorised to assign or licence of rights comprising the copyright : KRISHNA INSTITUTE OF MEDICAL SCIENCES "DEEMED TO BE UNIVERSITY", KARAD , NH4, PUNE - BANGALORE HIGHWAY, DIST.SATARA, AGASHIVNAGAR, MALKAPUR, MAHARASHTRA-415539 INDIAN



DEPUTY REGISTRAR OF COPYRIGHTS

13. If the work is an 'Artistic work', the location of the original work, including name, address and nationality of the person in possession of the work. (In the case of an architectural work, the year of completion of the work should also be shown). : N.A.
14. If the work is an 'Artistic work' which is used or capable of being used in relation to any goods or services, the application should include a certification from the Registrar of Trade Marks in terms of the provision to Sub-Section (i) of Section 45 of the Copyright Act, 1957. : N.A.
15. If the work is an 'Artistic work', whether it is registered under the Designs Act 2000 if yes give details. : N.A.
16. If the work is an 'Artistic work', capable of being registered as a design under the Designs Act 2000.whether it has been applied to an article though an industrial process and ,if yes ,the number of times it is reproduced. : N.A.
17. Remarks, if any :

Diary Number : 7882/2020-CO/L

Date of Application : 15/06/2020

Date of Receipt : 15/06/2020



A handwritten signature in blue ink, appearing to read 'M. M. M. S.', is written over a faint rectangular stamp.

DEPUTY REGISTRAR OF COPYRIGHTS



Dated : 20/08/2020

1. Registration Number : **L-93899/2020**
2. Name, address and nationality of the applicant : KRISHNA INSTITUTE OF MEDICAL SCIENCES "DEEMED TO BE UNIVERSITY", KARAD , NH4, PUNE - BANGALORE HIGHWAY, DIST.SATARA, AGASHIVNAGAR, MALKAPUR, MAHARASHTRA-NH4, PUNE - BANGALORE HIGHWAY, DIST.SATARA, AGASHIVNAGAR, MALKAPUR, MAHARASHTRA-415539
INDIAN
3. Nature of the applicant's interest in the copyright of the work : OWNER
4. Class and description of the work : LITERARY/ DRAMATIC WORK
5. Title of the work : FORENSIC MEDICINE AND TOXICOLOGY MOOT COURT 2020
6. Language of the work : ENGLISH
7. Name, address and nationality of the author and if the author is deceased, date of his decease : DR. CHANDRAKANT M KOKATANUR , DEPARTMENT OF FORENSIC MEDICINE & TOXICOLOGY, KRISHNA INSTITUTE OF MEDICAL SCIENCES "DEEMED TO BE UNIVERSITY, NH4, PUNE - BANGALORE HIGHWAY, DIST.SATARA, AGASHIVNAGAR, MALKAPUR, MAHARASHTRA-415539
INDIAN

DR AJAY V PATIL , DEPARTMENT OF FORENSIC MEDICINE & TOXICOLOGY, KRISHNA INSTITUTE OF MEDICAL SCIENCES "DEEMED TO BE UNIVERSITY, NH4, PUNE - BANGALORE HIGHWAY, DIST.SATARA, AGASHIVNAGAR, MALKAPUR, MAHARASHTRA-415539
INDIAN

DR VINAY BANNUR , DEPARTMENT OF FORENSIC MEDICINE & TOXICOLOGY, KRISHNA INSTITUTE OF MEDICAL SCIENCES "DEEMED TO BE UNIVERSITY, NH4, PUNE - BANGALORE HIGHWAY, DIST.SATARA, AGASHIVNAGAR, MALKAPUR, MAHARASHTRA-415539
INDIAN

DR KAPIL MORE , 1098, ANANDNAGAR APARTMENTS, FLAT NUMBER- FF2 BEHIND PHUTKA TALAV, SHANIVAR PETH, NEAR MATE RAM MANDIR-415539
INDIAN
8. Whether the work is published or unpublished : UNPUBLISHED
9. Year and country of first publication and name, address and nationality of the publisher : N.A.
10. Years and countries of subsequent publications, if any, and names, addresses and nationalities of the publishers : N.A.
11. Names, addresses and nationalities of the owners of various rights comprising the copyright in the work and the extent of rights held by each, together with particulars of assignments and licences, if any : KRISHNA INSTITUTE OF MEDICAL SCIENCES "DEEMED TO BE UNIVERSITY", KARAD , NH4, PUNE - BANGALORE HIGHWAY, DIST.SATARA, AGASHIVNAGAR, MALKAPUR, MAHARASHTRA-NH4, PUNE - BANGALORE HIGHWAY, DIST.SATARA, AGASHIVNAGAR, MALKAPUR, MAHARASHTRA-415539
INDIAN
12. Nationalities of other persons, if any, and licence of rights comprising the copyright : KRISHNA INSTITUTE OF MEDICAL SCIENCES "DEEMED TO BE UNIVERSITY", KARAD , NH4, PUNE - BANGALORE HIGHWAY, DIST.SATARA, AGASHIVNAGAR, MALKAPUR, MAHARASHTRA-NH4, PUNE - BANGALORE HIGHWAY, DIST.SATARA, AGASHIVNAGAR, MALKAPUR, MAHARASHTRA-415539
INDIAN

DEPUTY REGISTRAR OF COPYRIGHTS
MAHARASHTRA-415539
INDIAN
13. If the work is an 'Artistic work', the location of the original work, including name, address and nationality of the person in possession of the work. (In the case of an architectural work, the year of completion of the work should also be shown). : N.A.



14. If the work is an 'Artistic work' which is used or capable of being used in relation to any goods or services, the application should include a certification from the Registrar of Trade Marks in terms of the provision to Sub-Section (i) of Section 45 of the Copyright Act, 1957. : N.A.
15. If the work is an 'Artistic work', whether it is registered under the Designs Act 2000 if yes give details. : N.A.
16. If the work is an 'Artistic work', capable of being registered as a design under the Designs Act 2000.whether it has been applied to an article though an industrial process and ,if yes ,the number of times it is reproduced. : N.A.
17. Remarks, if any :
- Diary Number : 8274/2020-CO/L
- Date of Application : 22/06/2020
- Date of Receipt : 22/06/2020



A handwritten signature in blue ink, appearing to read 'M. M. M. S.', is written over a faint rectangular stamp.

DEPUTY REGISTRAR OF COPYRIGHTS



Dated : 19/08/2020

1. Registration Number : **L-93748/2020**
2. Name, address and nationality of the applicant : KRISHNA INSTITUTE OF MEDICAL SCIENCES "DEEMED TO BE UNIVERSITY", KARAD , KRISHNA INSTITUTE OF MEDICAL SCIENCES "DEEMED TO BE UNIVERSITY", KARAD, MALKAPUR, KARAD, DIST. SATARA, MAHARASHTRA, INDIA-415539 INDIAN
3. Nature of the applicant's interest in the copyright of the work : OWNER
4. Class and description of the work : LITERARY/ DRAMATIC WORK
5. Title of the work : EFFECTIVENESS OF VESTIBULAR STIMULATION TRAINING IN CEREBRAL PALSY
6. Language of the work : ENGLISH
7. Name, address and nationality of the author and if the author is deceased, date of his decease : MANDAR MALAWADE , KRISHNA INSTITUTE OF MEDICAL SCIENCES "DEEMED TO BE UNIVERSITY", KARAD, MALKAPUR, KARAD, DIST. SATARA, MAHARASHTRA, INDIA-415539 INDIAN
8. Whether the work is published or unpublished : UNPUBLISHED
9. Year and country of first publication and name, address and nationality of the publisher : N.A.
10. Years and countries of subsequent publications, if any, and names, addresses and nationalities of the publishers : N.A.
11. Names, addresses and nationalities of the owners of various rights comprising the copyright in the work and the extent of rights held by each, together with particulars of assignments and licences, if any : KRISHNA INSTITUTE OF MEDICAL SCIENCES "DEEMED TO BE UNIVERSITY", KARAD , KRISHNA INSTITUTE OF MEDICAL SCIENCES "DEEMED TO BE UNIVERSITY", KARAD, MALKAPUR, KARAD, DIST. SATARA, MAHARASHTRA, INDIA-415539 INDIAN
12. Names, addresses and nationalities of other persons, if any, authorised to assign or licence of rights comprising the copyright : N.A.
13. If the work is an 'Artistic work', the location of the original work, including name, address and nationality of the person in possession of the work. (In the case of an architectural work, the year of completion of the work should also be shown). : N.A.
14. If the work is an 'Artistic work' which is used or capable of being used in relation to any goods or services, the application should include a certification from the Registrar of Trade Marks in terms of the provision to Sub-Section (i) of Section 45 of the Copyright Act, 1957. : N.A.
15. If the work is an 'Artistic work', whether it is registered under the Designs Act 2000 if yes give details. : N.A.
16. If the work is an 'Artistic work', capable of being registered as a design under the Designs Act 2000.whether it has been applied to an article though an industrial process and ,if yes ,the number of times it is reproduced. : N.A.
17. Re : :



8503/2020-CO/L
25/06/2020
25/06/2020

DEPUTY REGISTRAR OF COPYRIGHTS



Dated : 24/08/2020

1. Registration Number : **L-93994/2020**
2. Name, address and nationality of the applicant : KRISHNA INSTITUTE OF MEDICAL SCIENCES "DEEMED TO BE UNIVERSITY", KARAD , KRISHNA INSTITUTE OF MEDICAL SCIENCES "DEEMED TO BE UNIVERSITY", KARAD, MALKAPUR, KARAD, DIST. SATARA, MAHARASHTRA, INDIA-415539 INDIAN
3. Nature of the applicant's interest in the copyright of the work : OWNER
4. Class and description of the work : LITERARY/ DRAMATIC WORK
5. Title of the work : EFFECTS OF CIRCUIT TRAINING PROGRAM ON QUALITY OF LIFE OF CHILDREN WITH HEMOPHILIA
6. Language of the work : ENGLISH
7. Name, address and nationality of the author and if the author is deceased, date of his decease : MANDAR MALAWADE , KRISHNA INSTITUTE OF MEDICAL SCIENCES "DEEMED TO BE UNIVERSITY", KARAD, MALKAPUR, KARAD, DIST. SATARA, MAHARASHTRA, INDIA-415539 INDIAN
8. Whether the work is published or unpublished : UNPUBLISHED
9. Year and country of first publication and name, address and nationality of the publisher : N.A.
10. Years and countries of subsequent publications, if any, and names, addresses and nationalities of the publishers : N.A.
11. Names, addresses and nationalities of the owners of various rights comprising the copyright in the work and the extent of rights held by each, together with particulars of assignments and licences, if any : KRISHNA INSTITUTE OF MEDICAL SCIENCES "DEEMED TO BE UNIVERSITY", KARAD , KRISHNA INSTITUTE OF MEDICAL SCIENCES "DEEMED TO BE UNIVERSITY", KARAD, MALKAPUR, KARAD, DIST. SATARA, MAHARASHTRA, INDIA-415539 INDIAN
12. Names, addresses and nationalities of other persons, if any, authorised to assign or licence of rights comprising the copyright : N.A.
13. If the work is an 'Artistic work', the location of the original work, including name, address and nationality of the person in possession of the work. (In the case of an architectural work, the year of completion of the work should also be shown). : N.A.
14. If the work is an 'Artistic work' which is used or capable of being used in relation to any goods or services, the application should include a certification from the Registrar of Trade Marks in terms of the provision to Sub-Section (i) of Section 45 of the Copyright Act, 1957. : N.A.
15. If the work is an 'Artistic work', whether it is registered under the Designs Act 2000 if yes give details. : N.A.
16. If the work is an 'Artistic work', capable of being registered as a design under the Designs Act 2000.whether it has been applied to an article though an industrial process and ,if yes ,the number of times it is reproduced. : N.A.
17. Re : :



8498/2020-CO/L
25/06/2020
25/06/2020

DEPUTY REGISTRAR OF COPYRIGHTS



Dated : 27/07/2020

1. Registration Number : **L-93097/2020**
2. Name, address and nationality of the applicant : KRISHNA INSTITUTE OF MEDICAL SCIENCES "DEEMED TO BE UNIVERSITY", KARAD , NH4, PUNE - BANGALORE HIGHWAY, DIST.SATARA, AGASHIVNAGAR, MALKAPUR, MAHARASHTRA-415539 INDIAN
3. Nature of the applicant's interest in the copyright of the work : OWNER
4. Class and description of the work : LITERARY/ DRAMATIC WORK
5. Title of the work : AQUA-MOBILIZATION WITH MOVEMENT
6. Language of the work : ENGLISH
7. Name, address and nationality of the author and if the author is deceased, date of his decease : DR. RADHIKA CHINTAMANI , NH4, PUNE - BANGALORE HIGHWAY, DIST.SATARA, AGASHIVNAGAR, MALKAPUR, MAHARASHTRA-415539 INDIAN
DR. AMRUTKUVAR RAYJADE , NH4, PUNE - BANGALORE HIGHWAY, DIST.SATARA, AGASHIVNAGAR, MALKAPUR, MAHARASHTRA-415539 INDIAN
8. Whether the work is published or unpublished : UNPUBLISHED
9. Year and country of first publication and name, address and nationality of the publisher : N.A.
10. Years and countries of subsequent publications, if any, and names, addresses and nationalities of the publishers : N.A.
11. Names, addresses and nationalities of the owners of various rights comprising the copyright in the work and the extent of rights held by each, together with particulars of assignments and licences, if any : KRISHNA INSTITUTE OF MEDICAL SCIENCES "DEEMED TO BE UNIVERSITY", KARAD , NH4, PUNE - BANGALORE HIGHWAY, DIST.SATARA, AGASHIVNAGAR, MALKAPUR, MAHARASHTRA-415539 INDIAN
12. Names, addresses and nationalities of other persons, if any, authorised to assign or licence of rights comprising the copyright : KRISHNA INSTITUTE OF MEDICAL SCIENCES "DEEMED TO BE UNIVERSITY", KARAD , NH4, PUNE - BANGALORE HIGHWAY, DIST.SATARA, AGASHIVNAGAR, MALKAPUR, MAHARASHTRA-415539 INDIAN
13. If the work is an 'Artistic work', the location of the original work, including name, address and nationality of the person in possession of the work. (In the case of an architectural work, the year of completion of the work should also be shown). : N.A.
14. If the work is an 'Artistic work' which is used or capable of being used in relation to any goods or services, the application should include a certification from the Registrar of Trade Marks in terms of the provision to Sub-Section (i) of Section 45 of the Copyright Act, 1957. : N.A.
15. If the work is an 'Artistic work', whether it is registered under the Designs Act 2000 if yes give details. : N.A.
16. If the work is an 'Artistic work', capable of being registered as a design under the Designs Act 2000, whether it has been applied to an industrial process and, if yes, the number of times : N.A.
17. :



7774/2020-CO/L

Date of Receipt : 12/06/2020

Date of Receipt : 12/06/2020

DEPUTY REGISTRAR OF COPYRIGHTS



Dated : 28/07/2020

1. Registration Number : **L-93141/2020**
2. Name, address and nationality of the applicant : KRISHNA INSTITUTE OF MEDICAL SCIENCES "DEEMED TO BE UNIVERSITY", KARAD , NH4, PUNE - BANGALORE HIGHWAY, DIST.SATARA, AGASHVYNAGAR, MALKAPUR, MAHARASHTRA-415539 INDIAN
3. Nature of the applicant's interest in the copyright of the work : OWNER
4. Class and description of the work : LITERARY/ DRAMATIC WORK
5. Title of the work : MOVEMENT RELATED PHOBIA-SPINE DISABILITY INDEX
6. Language of the work : ENGLISH
7. Name, address and nationality of the author and if the author is deceased, date of his decease : DR. RADHIKA CHINTAMANI , KRISHNA INSTITUTE OF MEDICAL SCIENCES DEEMED TO BE UNIVERSITY, NEAR DHEBEWADI ROAD, MALKAPUR TAL - KARAD. PIN - 415539 -415539 INDIAN
8. Whether the work is published or unpublished : UNPUBLISHED
9. Year and country of first publication and name, address and nationality of the publisher : N.A.
10. Years and countries of subsequent publications, if any, and names, addresses and nationalities of the publishers : N.A.
11. Names, addresses and nationalities of the owners of various rights comprising the copyright in the work and the extent of rights held by each, together with particulars of assignments and licences, if any : KRISHNA INSTITUTE OF MEDICAL SCIENCES "DEEMED TO BE UNIVERSITY", KARAD , NH4, PUNE - BANGALORE HIGHWAY, DIST.SATARA, AGASHVYNAGAR, MALKAPUR, MAHARASHTRA-415539 INDIAN
12. Names, addresses and nationalities of other persons, if any, authorised to assign or licence of rights comprising the copyright : KRISHNA INSTITUTE OF MEDICAL SCIENCES "DEEMED TO BE UNIVERSITY", KARAD , NH4, PUNE - BANGALORE HIGHWAY, DIST.SATARA, AGASHVYNAGAR, MALKAPUR, MAHARASHTRA-415539 INDIAN
13. If the work is an 'Artistic work', the location of the original work, including name, address and nationality of the person in possession of the work. (In the case of an architectural work, the year of completion of the work should also be shown). : N.A.
14. If the work is an 'Artistic work' which is used or capable of being used in relation to any goods or services, the application should include a certification from the Registrar of Trade Marks in terms of the provision to Sub-Section (i) of Section 45 of the Copyright Act, 1957. : N.A.
15. If the work is an 'Artistic work', whether it is registered under the Designs Act 2000 if yes give details. : N.A.
16. If the work is an 'Artistic work', capable of being registered as a design under the Designs Act 2000.whether it has been applied to an article though an industrial process and ,if yes ,the number of times it is reproduced. : N.A.
17. Re : :



7895/2020-CO/L
15/06/2020
15/06/2020

DEPUTY REGISTRAR OF COPYRIGHTS



Dated : 28/07/2020

1. Registration Number : **L-93142/2020**
2. Name, address and nationality of the applicant : KRISHNA INSTITUTE OF MEDICAL SCIENCES "DEEMED TO BE UNIVERSITY", KARAD , NH4, PUNE - BANGALORE HIGHWAY, DIST.SATARA, AGASHIVNAGAR, MALKAPUR, MAHARASHTRA-415539 INDIAN
3. Nature of the applicant's interest in the copyright of the work : OWNER
4. Class and description of the work : LITERARY/ DRAMATIC WORK
5. Title of the work : SELF STRUCTURED SCALE FOR EVALUATING PSYCHOLOGICAL PROBLEMS IN MENOPAUSAL WOMEN
6. Language of the work : ENGLISH
7. Name, address and nationality of the author and if the author is deceased, date of his decease : MRS. NUTAN POTDAR , KRISHNA INSTITUTE OF MEDICAL SCIENCES "DEEMED TO BE UNIVERSITY", KARAD NEAR DHEBEWADI ROAD, MALKAPUR TAL – KARAD. PIN – 415539 -415539 INDIAN
MRS. VAISHALI MOHITE , KRISHNA INSTITUTE OF MEDICAL SCIENCES "DEEMED TO BE UNIVERSITY", KARAD NEAR DHEBEWADI ROAD, MALKAPUR TAL – KARAD. PIN – 415539 DIST. – SATARA, MAHARASHTRA, INDIA-415539-415539 INDIAN
8. Whether the work is published or unpublished : UNPUBLISHED
9. Year and country of first publication and name, address and nationality of the publisher : N.A.
10. Years and countries of subsequent publications, if any, and names, addresses and nationalities of the publishers : N.A.
11. Names, addresses and nationalities of the owners of various rights comprising the copyright in the work and the extent of rights held by each, together with particulars of assignments and licences, if any : KRISHNA INSTITUTE OF MEDICAL SCIENCES "DEEMED TO BE UNIVERSITY", KARAD , NH4, PUNE - BANGALORE HIGHWAY, DIST.SATARA, AGASHIVNAGAR, MALKAPUR, MAHARASHTRA-415539 INDIAN
12. Names, addresses and nationalities of other persons, if any, authorised to assign or licence of rights comprising the copyright : KRISHNA INSTITUTE OF MEDICAL SCIENCES "DEEMED TO BE UNIVERSITY", KARAD , NH4, PUNE - BANGALORE HIGHWAY, DIST.SATARA, AGASHIVNAGAR, MALKAPUR, MAHARASHTRA-415539 INDIAN
13. If the work is an 'Artistic work', the location of the original work, including name, address and nationality of the person in possession of the work. (In the case of an architectural work, the year of completion of the work should also be shown). : N.A.
14. If the work is an 'Artistic work' which is used or capable of being used in relation to any goods or services, the application should include a certification from the Registrar of Trade Marks in terms of the provision to Sub-Section (i) of Section 45 of the Copyright Act, 1957. : N.A.
15. If the work is an 'Artistic work', whether it is registered under the Copyright Act, 1957, give details. : N.A.
16. If the work is an 'Artistic work', capable of being registered as a trademark under the Trademarks Act 2000, whether it has been applied to an article or service, if yes, the number of times it has been so applied. : N.A.
17. : N.A.



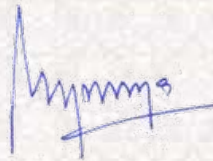

DEPUTY REGISTRAR OF COPYRIGHTS

Diary : 7903/2020-CO/L
Date of Application : 15/06/2020
Date of Receipt : 15/06/2020



Dated : 28/07/2020

1. Registration Number : **L-93144/2020**
2. Name, address and nationality of the applicant : KRISHNA INSTITUTE OF MEDICAL SCIENCES "DEEMED TO BE UNIVERSITY", KARAD , NH4, PUNE - BANGALORE HIGHWAY, DIST.SATARA, AGASHIVNAGAR, MALKAPUR, MAHARASHTRA-415539 INDIAN
3. Nature of the applicant's interest in the copyright of the work : OWNER
4. Class and description of the work : LITERARY/ DRAMATIC WORK
5. Title of the work : SELF STRUCTURED SCALE TO IDENTIFY STRESSORS PERCEIVED BY SECONDARY SCHOOL STUDENTS
6. Language of the work : ENGLISH
7. Name, address and nationality of the author and if the author is deceased, date of his decease : MRS. NUTAN POTDAR , KRISHNA INSTITUTE OF MEDICAL SCIENCES "DEEMED TO BE UNIVERSITY", KARAD NEAR DHEBEWADI ROAD, MALKAPUR TAL – KARAD. PIN – 415539 -415539 INDIAN
DR. C. D. AUNDHKAR , KRISHNA INSTITUTE OF MEDICAL SCIENCES "DEEMED TO BE UNIVERSITY", KARAD NEAR DHEBEWADI ROAD, MALKAPUR TAL – KARAD. PIN – 415539 DIST. – SATARA, MAHARASHTRA, INDIA-415539 INDIAN
MRS. VAISHALI MOHITE , KRISHNA INSTITUTE OF MEDICAL SCIENCES "DEEMED TO BE UNIVERSITY", KARAD NEAR DHEBEWADI ROAD, MALKAPUR TAL – KARAD. PIN – 415539 DIST. – SATARA, MAHARASHTRA, INDIA-415539 INDIAN
8. Whether the work is published or unpublished : UNPUBLISHED
9. Year and country of first publication and name, address and nationality of the publisher : N.A.
10. Years and countries of subsequent publications, if any, and names, addresses and nationalities of the publishers : N.A.
11. Names, addresses and nationalities of the owners of various rights comprising the copyright in the work and the extent of rights held by each, together with particulars of assignments and licences, if any : KRISHNA INSTITUTE OF MEDICAL SCIENCES "DEEMED TO BE UNIVERSITY", KARAD , NH4, PUNE - BANGALORE HIGHWAY, DIST.SATARA, AGASHIVNAGAR, MALKAPUR, MAHARASHTRA-415539 INDIAN
12. Names, addresses and nationalities of other persons, if any, authorised to assign or licence of rights comprising the copyright : KRISHNA INSTITUTE OF MEDICAL SCIENCES "DEEMED TO BE UNIVERSITY", KARAD , NH4, PUNE - BANGALORE HIGHWAY, DIST.SATARA, AGASHIVNAGAR, MALKAPUR, MAHARASHTRA-415539 INDIAN
13. If the work is an 'Artistic work', the location of the original work, including name, address and nationality of the person in possession of the work. (In the case of an architectural work, the year of completion of the work should also be shown). : N.A.
14. If the work is an 'Artistic work' which is used or capable of being used in connection with goods or services, the application should be filed from the Registrar of Trade Marks in terms of Section (i) of Section 45 of the Copyright Act, : N.A.
15. If the work is an 'Artistic work', whether it is registered under the Designs Act, 2000, give details. : N.A.
16. If the work is an 'Artistic work', capable of being registered as a design under the Designs Act 2000, whether it has been applied to an article though an industrial process and, if yes, the number of times it is reproduced. : N.A.
17. Remarks, if any : DEPUTY REGISTRAR OF COPYRIGHTS



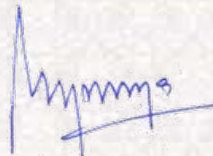



A handwritten signature in blue ink, appearing to read "M. M. M. S.", is written over a faint rectangular stamp.

DEPUTY REGISTRAR OF COPYRIGHTS



Dated : 24/08/2020

1. Registration Number : **L-94003/2020**
2. Name, address and nationality of the applicant : KRISHNA INSTITUTE OF MEDICAL SCIENCES "DEEMED TO BE UNIVERSITY", KARAD , NH4, PUNE - BANGALORE HIGHWAY, DIST.SATARA, AGASHIVNAGAR, MALKAPUR, MAHARASHTRA-415539 INDIAN
3. Nature of the applicant's interest in the copyright of the work : OWNER
4. Class and description of the work : LITERARY/ DRAMATIC WORK
5. Title of the work : DIABETIC EDUCATION PROGRAMME FOR TYPE-1 DIABETES MELLITUS CHILDREN ON : "SELF CARE MANAGEMENT IN TYPE -1 DIABETES MELLITUS"
6. Language of the work : ENGLISH
7. Name, address and nationality of the author and if the author is deceased, date of his decease : MRS. RAJASHRI BHAGWAT KARALE , DEPARTMENT OF CHILD HEALTH NURSING KRISHNA INSTITUTE OF MEDICAL SCIENCES DEEMED TO BE UNIVERSITY, MALKAPUR- 415539, KARAD. MAHARASHTRA, INDIA-415539 INDIAN
8. Whether the work is published or unpublished : UNPUBLISHED
9. Year and country of first publication and name, address and nationality of the publisher : N.A.
10. Years and countries of subsequent publications, if any, and names, addresses and nationalities of the publishers : N.A.
11. Names, addresses and nationalities of the owners of various rights comprising the copyright in the work and the extent of rights held by each, together with particulars of assignments and licences, if any : KRISHNA INSTITUTE OF MEDICAL SCIENCES "DEEMED TO BE UNIVERSITY", KARAD , NH4, PUNE - BANGALORE HIGHWAY, DIST.SATARA, AGASHIVNAGAR, MALKAPUR, MAHARASHTRA-415539 INDIAN
12. Names, addresses and nationalities of other persons, if any, authorised to assign or licence of rights comprising the copyright : KRISHNA INSTITUTE OF MEDICAL SCIENCES "DEEMED TO BE UNIVERSITY", KARAD , NH4, PUNE - BANGALORE HIGHWAY, DIST.SATARA, AGASHIVNAGAR, MALKAPUR, MAHARASHTRA-415539 INDIAN
13. If the work is an 'Artistic work', the location of the original work, including name, address and nationality of the person in possession of the work. (In the case of an architectural work, the year of completion of the work should also be shown). : N.A.
14. If the work is an 'Artistic work' which is used or capable of being used in relation to any goods or services, the application should include a certification from the Registrar of Trade Marks in terms of the provision to Sub-Section (i) of Section 45 of the Copyright Act, 1957. : N.A.
15. If the work is an 'Artistic work', whether it is registered under the Designs Act 2000 if yes give details. : N.A.
16. If the work is an 'Artistic work', capable of being registered as a design under the Designs Act 2000, whether it has been applied to an article, industrial process and ,if yes ,the number of times : N.A.
17. :



9184/2020-CO/L

07/07/2020

07/07/2020

Date

DEPUTY REGISTRAR OF COPYRIGHTS



Dated : 03/09/2020

1. Registration Number : **L-94392/2020**
2. Name, address and nationality of the applicant : KRISHNA INSTITUTE OF MEDICAL SCIENCES "DEEMED TO BE UNIVERSITY", KARAD , NH4, PUNE - BANGALORE HIGHWAY, DIST.SATARA, AGASHIVNAGAR, MALKAPUR, MAHARASHTRA-415539 INDIAN
3. Nature of the applicant's interest in the copyright of the work : OWNER
4. Class and description of the work : LITERARY/ DRAMATIC WORK
5. Title of the work : HAND WASHING TECHNIQUES
6. Language of the work : ENGLISH
7. Name, address and nationality of the author and if the author is deceased, date of his decease : DR. KAPIL MANIK MORE , A/P- SARUD, NAVEEN VASAHAAT, TAL-SHAHUWADI, DIST-KOLHAPUR,MAHARASHTRA, INDIA-416214 INDIAN
DR. AJAY V. PATIL , B2/8, STAFF QUARTERS, KIMS CAMPUS, MALKAPUR, KARAD, MAHARASHTRA, INDIA-415539 INDIAN
8. Whether the work is published or unpublished : UNPUBLISHED
9. Year and country of first publication and name, address and nationality of the publisher : N.A.
10. Years and countries of subsequent publications, if any, and names, addresses and nationalities of the publishers : N.A.
11. Names, addresses and nationalities of the owners of various rights comprising the copyright in the work and the extent of rights held by each, together with particulars of assignments and licences, if any : KRISHNA INSTITUTE OF MEDICAL SCIENCES "DEEMED TO BE UNIVERSITY", KARAD , NH4, PUNE - BANGALORE HIGHWAY, DIST.SATARA, AGASHIVNAGAR, MALKAPUR, MAHARASHTRA-415539 INDIAN
12. Names, addresses and nationalities of other persons, if any, authorised to assign or licence of rights comprising the copyright : KRISHNA INSTITUTE OF MEDICAL SCIENCES "DEEMED TO BE UNIVERSITY", KARAD , NH4, PUNE - BANGALORE HIGHWAY, DIST.SATARA, AGASHIVNAGAR, MALKAPUR, MAHARASHTRA-415539 INDIAN
13. If the work is an 'Artistic work', the location of the original work, including name, address and nationality of the person in possession of the work. (In the case of an architectural work, the year of completion of the work should also be shown). : N.A.
14. If the work is an 'Artistic work' which is used or capable of being used in relation to any goods or services, the application should include a certification from the Registrar of Trade Marks in terms of the provision to Sub-Section (i) of Section 45 of the Copyright Act, 1957. : N.A.
15. If the work is an 'Artistic work', whether it is registered under the Designs Act 2000 if yes give details. : N.A.
16. If the work is an 'Artistic work', capable of being registered as a design under the Designs Act 2000, whether it has been applied to an article, if yes, the number of times : N.A.



9970/2020-CO/L

21/07/2020

Date of registration : 21/07/2020

DEPUTY REGISTRAR OF COPYRIGHTS



Dated : 03/09/2020

1. Registration Number : **L-94390/2020**
2. Name, address and nationality of the applicant : KRISHNA INSTITUTE OF MEDICAL SCIENCES "DEEMED TO BE UNIVERSITY", KARAD , NH4, PUNE - BANGALORE HIGHWAY, DIST.SATARA, AGASHIVNAGAR, MALKAPUR, MAHARASHTRA-415539 INDIAN
3. Nature of the applicant's interest in the copyright of the work : OWNER
4. Class and description of the work : LITERARY/ DRAMATIC WORK
5. Title of the work : CORRECT WAY TO USE SINGLE USE MASK DURING COVID 19 PANDEMIC
6. Language of the work : ENGLISH
7. Name, address and nationality of the author and if the author is deceased, date of his decease : DR. KAPIL MANIK MORE , A/P- SARUD, NAVEEN VASAHAT, TAL-SHAHUWADI, DIST- KOLHAPUR,MAHARASHTRA, INDIA, PIN CODE : 416214-416214 INDIAN
DR. AJAY V. PATIL , B2/8, STAFF QUARTERS, KIMS CAMPUS, MALKAPUR, KARAD, MAHARASHTRA, INDIA,- 415539 INDIAN
8. Whether the work is published or unpublished : UNPUBLISHED
9. Year and country of first publication and name, address and nationality of the publisher : N.A.
10. Years and countries of subsequent publications, if any, and names, addresses and nationalities of the publishers : N.A.
11. Names, addresses and nationalities of the owners of various rights comprising the copyright in the work and the extent of rights held by each, together with particulars of assignments and licences, if any : KRISHNA INSTITUTE OF MEDICAL SCIENCES "DEEMED TO BE UNIVERSITY", KARAD , NH4, PUNE - BANGALORE HIGHWAY, DIST.SATARA, AGASHIVNAGAR, MALKAPUR, MAHARASHTRA-415539 INDIAN
12. Names, addresses and nationalities of other persons, if any, authorised to assign or licence of rights comprising the copyright : KRISHNA INSTITUTE OF MEDICAL SCIENCES "DEEMED TO BE UNIVERSITY", KARAD , NH4, PUNE - BANGALORE HIGHWAY, DIST.SATARA, AGASHIVNAGAR, MALKAPUR, MAHARASHTRA-415539 INDIAN
13. If the work is an 'Artistic work', the location of the original work, including name, address and nationality of the person in possession of the work. (In the case of an architectural work, the year of completion of the work should also be shown). : N.A.
14. If the work is an 'Artistic work' which is used or capable of being used in relation to any goods or services, the application should include a certification from the Registrar of Trade Marks in terms of the provision to Sub-Section (i) of Section 45 of the Copyright Act, 1957. : N.A.
15. If the work is an 'Artistic work', whether it is registered under the Designs Act, 2000 if yes give details. : N.A.
16. If the work is an 'Artistic work', capable of being registered as a design under the Designs Act 2000.whether it has been applied to an article, the date of application, the date of registration and ,if yes ,the number of times : N.A.
17. :



Registration Number : 9962/2020-CO/L
Date of Application : 21/07/2020
Date of Receipt : 21/07/2020

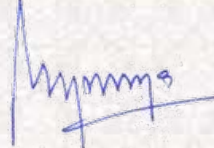

DEPUTY REGISTRAR OF COPYRIGHTS



Dated : 03/09/2020

1. Registration Number : **L-94394/2020**
2. Name, address and nationality of the applicant : KRISHNA INSTITUTE OF MEDICAL SCIENCES "DEEMED TO BE UNIVERSITY", KARAD , NH4, PUNE - BANGALORE HIGHWAY, DIST.SATARA, AGASHIVNAGAR, MALKAPUR, MAHARASHTRA-415539 INDIAN
3. Nature of the applicant's interest in the copyright of the work : OWNER
4. Class and description of the work : LITERARY/ DRAMATIC WORK
5. Title of the work : TRUTH AND MISCONCEPTIONS ABOUT COVID 19
6. Language of the work : ENGLISH
7. Name, address and nationality of the author and if the author is deceased, date of his decease : DR. KAPIL MANIK MORE , A/P- SARUD, NAVEEN VASAHAAT, TAL-SHAHUWADI, DIST-KOLHAPUR,MAHARASHTRA, INDIA-416214 INDIAN
DR. AJAY V. PATIL , B2/8, STAFF QUARTERS, KIMS CAMPUS, MALKAPUR, KARAD, MAHARASHTRA, INDIA-415539 INDIAN
8. Whether the work is published or unpublished : UNPUBLISHED
9. Year and country of first publication and name, address and nationality of the publisher : N.A.
10. Years and countries of subsequent publications, if any, and names, addresses and nationalities of the publishers : N.A.
11. Names, addresses and nationalities of the owners of various rights comprising the copyright in the work and the extent of rights held by each, together with particulars of assignments and licences, if any : KRISHNA INSTITUTE OF MEDICAL SCIENCES "DEEMED TO BE UNIVERSITY", KARAD , NH4, PUNE - BANGALORE HIGHWAY, DIST.SATARA, AGASHIVNAGAR, MALKAPUR, MAHARASHTRA-415539 INDIAN
12. Names, addresses and nationalities of other persons, if any, authorised to assign or licence of rights comprising the copyright : KRISHNA INSTITUTE OF MEDICAL SCIENCES "DEEMED TO BE UNIVERSITY", KARAD , NH4, PUNE - BANGALORE HIGHWAY, DIST.SATARA, AGASHIVNAGAR, MALKAPUR, MAHARASHTRA-415539 INDIAN
13. If the work is an 'Artistic work', the location of the original work, including name, address and nationality of the person in possession of the work. (In the case of an architectural work, the year of completion of the work should also be shown). : N.A.
14. If the work is an 'Artistic work' which is used or capable of being used in relation to any goods or services, the application should include a certification from the Registrar of Trade Marks in terms of the provision to Sub-Section (i) of Section 45 of the Copyright Act, 1957. : N.A.
15. If the work is an 'Artistic work', whether it is registered under the Designs Act 2000 if yes give details. : N.A.
16. If the work is an 'Artistic work', capable of being registered as a design under the Designs Act 2000, whether it has been applied to an article, if yes, the number of times : N.A.



9973/2020-CO/L

21/07/2020

Date of registration : 21/07/2020

DEPUTY REGISTRAR OF COPYRIGHTS



Dated : 03/09/2020

1. Registration Number : **L-94391/2020**
2. Name, address and nationality of the applicant : KRISHNA INSTITUTE OF MEDICAL SCIENCES "DEEMED TO BE UNIVERSITY", KARAD , NH4, PUNE - BANGALORE HIGHWAY, DIST.SATARA, AGASHIVNAGAR, MALKAPUR, MAHARASHTRA-415539 INDIAN
3. Nature of the applicant's interest in the copyright of the work : OWNER
4. Class and description of the work : LITERARY/ DRAMATIC WORK
5. Title of the work : SOCIAL DISTANCING PRACTICES DURING COVID 19 PANDEMIC
6. Language of the work : ENGLISH
7. Name, address and nationality of the author and if the author is deceased, date of his decease : DR. KAPIL MANIK MORE , A/P- SARUD, NAVEEN VASAHAT, TAL-SHAHUWADI, DIST-KOLHAPUR,MAHARASHTRA, INDIA, PIN CODE : 416214-416214 INDIAN
DR. AJAY V. PATIL , B2/8, STAFF QUARTERS, KIMS CAMPUS, MALKAPUR, KARAD, MAHARASHTRA, INDIA, PIN CODE: 415539.-415539 INDIAN
8. Whether the work is published or unpublished : UNPUBLISHED
9. Year and country of first publication and name, address and nationality of the publisher : N.A.
10. Years and countries of subsequent publications, if any, and names, addresses and nationalities of the publishers : N.A.
11. Names, addresses and nationalities of the owners of various rights comprising the copyright in the work and the extent of rights held by each, together with particulars of assignments and licences, if any : KRISHNA INSTITUTE OF MEDICAL SCIENCES "DEEMED TO BE UNIVERSITY", KARAD , NH4, PUNE - BANGALORE HIGHWAY, DIST.SATARA, AGASHIVNAGAR, MALKAPUR, MAHARASHTRA-415539 INDIAN
12. Names, addresses and nationalities of other persons, if any, authorised to assign or licence of rights comprising the copyright : KRISHNA INSTITUTE OF MEDICAL SCIENCES "DEEMED TO BE UNIVERSITY", KARAD , NH4, PUNE - BANGALORE HIGHWAY, DIST.SATARA, AGASHIVNAGAR, MALKAPUR, MAHARASHTRA-415539 INDIAN
13. If the work is an 'Artistic work', the location of the original work, including name, address and nationality of the person in possession of the work. (In the case of an architectural work, the year of completion of the work should also be shown). : N.A.
14. If the work is an 'Artistic work' which is used or capable of being used in relation to any goods or services, the application should include a certification from the Registrar of Trade Marks in terms of the provision to Sub-Section (i) of Section 45 of the Copyright Act, 1957. : N.A.
15. If the work is an 'Artistic work', whether it is registered under the Designs Act, 2000 if yes give details. : N.A.
16. If the work is an 'Artistic work', capable of being registered as a design under the Designs Act 2000.whether it has been applied to an article, the date of application, the date of registration and ,if yes ,the number of times : N.A.
17. :



9966/2020-CO/L

Date of Registration : 21/07/2020

Date of Receipt : 21/07/2020

DEPUTY REGISTRAR OF COPYRIGHTS



Dated : 03/09/2020

1. Registration Number : **L-94395/2020**
2. Name, address and nationality of the applicant : KRISHNA INSTITUTE OF MEDICAL SCIENCES "DEEMED TO BE UNIVERSITY", KARAD , NH4, PUNE - BANGALORE HIGHWAY, DIST.SATARA, AGASHIVNAGAR, MALKAPUR, MAHARASHTRA-415539 INDIAN
3. Nature of the applicant's interest in the copyright of the work : OWNER
4. Class and description of the work : LITERARY/ DRAMATIC WORK
5. Title of the work : RESPONSIBILITIES OF PEOPLE IN COVID 19 PANDEMIC
6. Language of the work : ENGLISH
7. Name, address and nationality of the author and if the author is deceased, date of his decease : DR. KAPIL MANIK MORE , A/P- SARUD, NAVEEN VASAHAAT, TAL-SHAHUWADI, DIST-KOLHAPUR,MAHARASHTRA, INDIA-416214 INDIAN
DR. AJAY V. PATIL , B2/8, STAFF QUARTERS, KIMS CAMPUS, MALKAPUR, KARAD, MAHARASHTRA, INDIA-415539 INDIAN
8. Whether the work is published or unpublished : UNPUBLISHED
9. Year and country of first publication and name, address and nationality of the publisher : N.A.
10. Years and countries of subsequent publications, if any, and names, addresses and nationalities of the publishers : N.A.
11. Names, addresses and nationalities of the owners of various rights comprising the copyright in the work and the extent of rights held by each, together with particulars of assignments and licences, if any : KRISHNA INSTITUTE OF MEDICAL SCIENCES "DEEMED TO BE UNIVERSITY", KARAD , NH4, PUNE - BANGALORE HIGHWAY, DIST.SATARA, AGASHIVNAGAR, MALKAPUR, MAHARASHTRA-415539 INDIAN
12. Names, addresses and nationalities of other persons, if any, authorised to assign or licence of rights comprising the copyright : KRISHNA INSTITUTE OF MEDICAL SCIENCES "DEEMED TO BE UNIVERSITY", KARAD , NH4, PUNE - BANGALORE HIGHWAY, DIST.SATARA, AGASHIVNAGAR, MALKAPUR, MAHARASHTRA-415539 INDIAN
13. If the work is an 'Artistic work', the location of the original work, including name, address and nationality of the person in possession of the work. (In the case of an architectural work, the year of completion of the work should also be shown). : N.A.
14. If the work is an 'Artistic work' which is used or capable of being used in relation to any goods or services, the application should include a certification from the Registrar of Trade Marks in terms of the provision to Sub-Section (i) of Section 45 of the Copyright Act, 1957. : N.A.
15. If the work is an 'Artistic work', whether it is registered under the Designs Act 2000 if yes give details. : N.A.
16. If the work is an 'Artistic work', capable of being registered as a design under the Designs Act 2000, whether it has been applied to an article, if yes, the number of times : N.A.



9978/2020-CO/L

21/07/2020

Date of registration : 21/07/2020

DEPUTY REGISTRAR OF COPYRIGHTS



Dated : 13/08/2020

1. Registration Number : **L-93520/2020**
2. Name, address and nationality of the applicant : KRISHNA INSTITUTE OF MEDICAL SCIENCES "DEEMED TO BE UNIVERSITY", KARAD , KRISHNA INSTITUTE OF MEDICAL SCIENCES "DEEMED TO BE UNIVERSITY", KARAD, MALKAPUR, KARAD, DIST. SATARA, MAHARASHTRA, INDIA-415539 INDIAN
3. Nature of the applicant's interest in the copyright of the work : OWNER
4. Class and description of the work : LITERARY/ DRAMATIC WORK
5. Title of the work : SCOPE OF RESPIRATORY PHYSIOTHERAPIST IN COVID-19 PATIENTS - PRESENT AND FUTURE
6. Language of the work : ENGLISH
7. Name, address and nationality of the author and if the author is deceased, date of his decease : DR. T. POOVISHNU DEVI , KRISHNA INSTITUTE OF MEDICAL SCIENCES "DEEMED TO BE UNIVERSITY", KARAD, MALKAPUR, KARAD, DIST. SATARA, MAHARASHTRA, INDIA-415539 INDIAN
8. Whether the work is published or unpublished : UNPUBLISHED
9. Year and country of first publication and name, address and nationality of the publisher : N.A.
10. Years and countries of subsequent publications, if any, and names, addresses and nationalities of the publishers : N.A.
11. Names, addresses and nationalities of the owners of various rights comprising the copyright in the work and the extent of rights held by each, together with particulars of assignments and licences, if any : KRISHNA INSTITUTE OF MEDICAL SCIENCES "DEEMED TO BE UNIVERSITY", KARAD , KRISHNA INSTITUTE OF MEDICAL SCIENCES "DEEMED TO BE UNIVERSITY", KARAD, MALKAPUR, KARAD, DIST. SATARA, MAHARASHTRA, INDIA-415539 INDIAN
12. Names, addresses and nationalities of other persons, if any, authorised to assign or licence of rights comprising the copyright : N.A.
13. If the work is an 'Artistic work', the location of the original work, including name, address and nationality of the person in possession of the work. (In the case of an architectural work, the year of completion of the work should also be shown). : N.A.
14. If the work is an 'Artistic work' which is used or capable of being used in relation to any goods or services, the application should include a certification from the Registrar of Trade Marks in terms of the provision to Sub-Section (i) of Section 45 of the Copyright Act, 1957. : N.A.
15. If the work is an 'Artistic work', whether it is registered under the Designs Act 2000 if yes give details. : N.A.
16. If the work is an 'Artistic work', capable of being registered as a design under the Designs Act 2000, whether it has been applied to an article though an industrial process and ,if yes ,the number of times it is reproduced. : N.A.
17. Re : :



8827/2020-CO/L
01/07/2020
01/07/2020

DEPUTY REGISTRAR OF COPYRIGHTS



Dated : 24/09/2020

1. Registration Number : **L-95045/2020**
2. Name, address and nationality of the applicant : KRISHNA INSTITUTE OF MEDICAL SCIENCES "DEEMED TO BE UNIVERSITY", KARAD , NH4, PUNE - BANGALORE HIGHWAY, DIST.SATARA, AGASHIVNAGAR, MALKAPUR, MAHARASHTRA-415539 INDIAN
3. Nature of the applicant's interest in the copyright of the work : OWNER
4. Class and description of the work : LITERARY/ DRAMATIC WORK
5. Title of the work : ONLINE SEMINAR ON DENTAL FINDINGS IN EARLY AGE ESTIMATION DURING COVID 19 PANDEMIC
6. Language of the work : ENGLISH
7. Name, address and nationality of the author and if the author is deceased, date of his decease : DR. CHANDRAKANT M KOKATANUR , DEPARTMENT OF FORENSIC MEDICINE & TOXICOLOGY, KRISHNA INSTITUTE OF MEDICAL SCIENCES "DEEMED TO BE UNIVERSITY, KARAD NH4, PUNE - BANGALORE HIGHWAY, DIST.SATARA, AGASHIVNAGAR, MALKAPUR, MAHARASHTRA-415539 INDIAN
DR AJAY V PATIL , DEPARTMENT OF FORENSIC MEDICINE & TOXICOLOGY, KRISHNA INSTITUTE OF MEDICAL SCIENCES "DEEMED TO BE UNIVERSITY, KARAD NH4, PUNE - BANGALORE HIGHWAY, DIST.SATARA, AGASHIVNAGAR, MALKAPUR, MAHARASHTRA-415539 INDIAN
DR VINAY BANNUR , DEPARTMENT OF FORENSIC MEDICINE & TOXICOLOGY, KRISHNA INSTITUTE OF MEDICAL SCIENCES "DEEMED TO BE UNIVERSITY, KARAD NH4, PUNE - BANGALORE HIGHWAY, DIST.SATARA, AGASHIVNAGAR, MALKAPUR, MAHARASHTRA-415539 INDIAN
MS SRISHTI SINHA , DEPARTMENT OF FORENSIC MEDICINE & TOXICOLOGY, KRISHNA INSTITUTE OF MEDICAL SCIENCES "DEEMED TO BE UNIVERSITY, KARAD NH4, PUNE - BANGALORE HIGHWAY, DIST.SATARA, AGASHIVNAGAR, MALKAPUR, MAHARASHTRA-415539 INDIAN
8. Whether the work is published or unpublished : UNPUBLISHED
9. Year and country of first publication and name, address and nationality of the publisher : N.A.
10. Years and countries of subsequent publications, if any, and names, addresses and nationalities of the publishers : N.A.
11. Names, addresses and nationalities of the owners of various rights comprising the copyright in the work and the extent of rights held by each, together with particulars of assignments and licences, if any : KRISHNA INSTITUTE OF MEDICAL SCIENCES "DEEMED TO BE UNIVERSITY", KARAD , NH4, PUNE - BANGALORE HIGHWAY, DIST.SATARA, AGASHIVNAGAR, MALKAPUR, MAHARASHTRA-415539 INDIAN
12. Names, addresses and nationalities of other persons, if any, and the extent of their licence of rights comprising the copyright : KRISHNA INSTITUTE OF MEDICAL SCIENCES "DEEMED TO BE UNIVERSITY", KARAD , NH4, PUNE - BANGALORE HIGHWAY, DIST.SATARA, AGASHIVNAGAR, MALKAPUR, MAHARASHTRA-415539 INDIAN
13. If the work is an 'Artistic work', the location of the original work, the name and address and nationality of the person in possession of the work and in the case of an architectural work, the year of completion of the work should also be shown). : N.A.
14. If the work is an 'Artistic work' which is used or capable of being used in relation to any goods or services, the application should include a certification from the Registrar of Trade Marks in terms of the provision to Sub-Section (i) of Section 45 of the Copyright Act, 1957. : N.A.

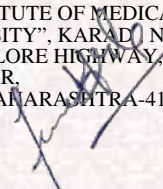

DEPUTY REGISTRAR OF COPYRIGHTS

15. If the work is an 'Artistic work', whether it is registered under the Designs Act 2000 if yes give details. : N.A.
16. If the work is an 'Artistic work', capable of being registered as a design under the Designs Act 2000.whether it has been applied to an article though an industrial process and ,if yes ,the number of times it is reproduced. : N.A.
17. Remarks, if any :
- Diary Number : 11344/2020-CO/L
- Date of Application : 14/08/2020
- Date of Receipt : 14/08/2020



A handwritten signature in blue ink, appearing to read 'S. Prasad', is written over a horizontal line.

DEPUTY REGISTRAR OF COPYRIGHTS



Dated : 26/08/2020

1. Registration Number : **L-94106/2020**
2. Name, address and nationality of the applicant : KRISHNA INSTITUTE OF MEDICAL SCIENCES "DEEMED TO BE UNIVERSITY", KARAD , KRISHNA INSTITUTE OF MEDICAL SCIENCES "DEEMED TO BE UNIVERSITY", KARAD, MALKAPUR, KARAD, DIST. SATARA, MAHARASHTRA, INDIA-415539 INDIAN
3. Nature of the applicant's interest in the copyright of the work : OWNER
4. Class and description of the work : LITERARY/ DRAMATIC WORK
5. Title of the work : COMPREHENSIVE FOR DENTAL ANATOMY SUBJECT (APPLYING GAME BASED APPROACH) TAUGHT FOR DENTAL LEARNERS
6. Language of the work : ENGLISH
7. Name, address and nationality of the author and if the author is deceased, date of his decease : DR. SUSHMA BOMMANAVAR , ORAL PATHOLOGY, KRISHNA INSTITUTE OF MEDICAL SCIENCES "DEEMED TO BE UNIVERSITY", KARAD, MALKAPUR, KARAD, DIST. SATARA, MAHARASHTRA, INDIA-415539 INDIAN
8. Whether the work is published or unpublished : UNPUBLISHED
9. Year and country of first publication and name, address and nationality of the publisher : N.A.
10. Years and countries of subsequent publications, if any, and names, addresses and nationalities of the publishers : N.A.
11. Names, addresses and nationalities of the owners of various rights comprising the copyright in the work and the extent of rights held by each, together with particulars of assignments and licences, if any : KRISHNA INSTITUTE OF MEDICAL SCIENCES "DEEMED TO BE UNIVERSITY", KARAD , KRISHNA INSTITUTE OF MEDICAL SCIENCES "DEEMED TO BE UNIVERSITY", KARAD, MALKAPUR, KARAD, DIST. SATARA, MAHARASHTRA, INDIA-415539 INDIAN
12. Names, addresses and nationalities of other persons, if any, authorised to assign or licence of rights comprising the copyright : N.A.
13. If the work is an 'Artistic work', the location of the original work, including name, address and nationality of the person in possession of the work. (In the case of an architectural work, the year of completion of the work should also be shown). : N.A.
14. If the work is an 'Artistic work' which is used or capable of being used in relation to any goods or services, the application should include a certification from the Registrar of Trade Marks in terms of the provision to Sub-Section (i) of Section 45 of the Copyright Act, 1957. : N.A.
15. If the work is an 'Artistic work', whether it is registered under the Designs Act 2000 if yes give details. : N.A.
16. If the work is an 'Artistic work', capable of being registered as a design under the Designs Act 2000, whether it has been applied to an article though an industrial process and ,if yes ,the number of times it is reproduced. : N.A.
17. Remarks :



9149/2020-CO/L

06/07/2020

06/07/2020

DEPUTY REGISTRAR OF COPYRIGHTS



Dated : 13/08/2020

1. Registration Number : **L-93519/2020**
2. Name, address and nationality of the applicant : KRISHNA INSTITUTE OF MEDICAL SCIENCES "DEEMED TO BE UNIVERSITY", KARAD , KRISHNA INSTITUTE OF MEDICAL SCIENCES "DEEMED TO BE UNIVERSITY", KARAD, MALKAPUR, KARAD, DIST. SATARA, MAHARASHTRA, INDIA-415539 INDIAN
3. Nature of the applicant's interest in the copyright of the work : OWNER
4. Class and description of the work : LITERARY/ DRAMATIC WORK
5. Title of the work : COMPREHENSIVE FOR DENTAL HISTOLOGY SUBJECT (APPLYING GAME BASED APPROACH) TAUGHT FOR DENTAL LEARNERS
6. Language of the work : ENGLISH
7. Name, address and nationality of the author and if the author is deceased, date of his decease : DR. SUSHMA BOMMANAVAR , ORAL PATHOLOGY, KRISHNA INSTITUTE OF MEDICAL SCIENCES "DEEMED TO BE UNIVERSITY", KARAD, MALKAPUR, KARAD, DIST. SATARA, MAHARASHTRA, INDIA-415539 INDIAN
8. Whether the work is published or unpublished : UNPUBLISHED
9. Year and country of first publication and name, address and nationality of the publisher : N.A.
10. Years and countries of subsequent publications, if any, and names, addresses and nationalities of the publishers : N.A.
11. Names, addresses and nationalities of the owners of various rights comprising the copyright in the work and the extent of rights held by each, together with particulars of assignments and licences, if any : KRISHNA INSTITUTE OF MEDICAL SCIENCES "DEEMED TO BE UNIVERSITY", KARAD , KRISHNA INSTITUTE OF MEDICAL SCIENCES "DEEMED TO BE UNIVERSITY", KARAD, MALKAPUR, KARAD, DIST. SATARA, MAHARASHTRA, INDIA-415539 INDIAN
12. Names, addresses and nationalities of other persons, if any, authorised to assign or licence of rights comprising the copyright : N.A.
13. If the work is an 'Artistic work', the location of the original work, including name, address and nationality of the person in possession of the work. (In the case of an architectural work, the year of completion of the work should also be shown). : N.A.
14. If the work is an 'Artistic work' which is used or capable of being used in relation to any goods or services, the application should include a certification from the Registrar of Trade Marks in terms of the provision to Sub-Section (i) of Section 45 of the Copyright Act, 1957. : N.A.
15. If the work is an 'Artistic work', whether it is registered under the Designs Act 2000 if yes give details. : N.A.
16. If the work is an 'Artistic work', capable of being registered as a design under the Designs Act 2000. whether it has been applied to an article though an industrial process and ,if yes ,the number of times it is registered. : N.A.
17. F :



8832/2020-CO/L
01/07/2020
01/07/2020

DEPUTY REGISTRAR OF COPYRIGHTS



Dated : 08/10/2020

1. Registration Number : **L-95517/2020**
2. Name, address and nationality of the applicant : KRISHNA INSTITUTE OF MEDICAL SCIENCES "DEEMED TO BE UNIVERSITY", KARAD , KRISHNA INSTITUTE OF MEDICAL SCIENCES "DEEMED TO BE UNIVERSITY", KARAD, MALKAPUR, KARAD, DIST. SATARA, MAHARASHTRA, INDIA-415539 INDIAN
3. Nature of the applicant's interest in the copyright of the work : OWNER
4. Class and description of the work : LITERARY/ DRAMATIC WORK
5. Title of the work : COMPREHENSIVE FOR ORAL PATHOLOGY SUBJECT (APPLYING GAME BASED APPROACH) TAUGHT FOR DENTAL LEARNERS
6. Language of the work : ENGLISH
7. Name, address and nationality of the author and if the author is deceased, date of his decease : DR. SUSHMA BOMMANAVAR , ORAL PATHOLOGY, KRISHNA INSTITUTE OF MEDICAL SCIENCES "DEEMED TO BE UNIVERSITY", KARAD, MALKAPUR, KARAD, DIST. SATARA, MAHARASHTRA, INDIA-415539 INDIAN
8. Whether the work is published or unpublished : UNPUBLISHED
9. Year and country of first publication and name, address and nationality of the publisher : N.A.
10. Years and countries of subsequent publications, if any, and names, addresses and nationalities of the publishers : N.A.
11. Names, addresses and nationalities of the owners of various rights comprising the copyright in the work and the extent of rights held by each, together with particulars of assignments and licences, if any : KRISHNA INSTITUTE OF MEDICAL SCIENCES "DEEMED TO BE UNIVERSITY", KARAD , KRISHNA INSTITUTE OF MEDICAL SCIENCES "DEEMED TO BE UNIVERSITY", KARAD, MALKAPUR, KARAD, DIST. SATARA, MAHARASHTRA, INDIA-415539 INDIAN
12. Names, addresses and nationalities of other persons, if any, authorised to assign or licence of rights comprising the copyright : N.A.
13. If the work is an 'Artistic work', the location of the original work, including name, address and nationality of the person in possession of the work. (In the case of an architectural work, the year of completion of the work should also be shown). : N.A.
14. If the work is an 'Artistic work' which is used or capable of being used in relation to any goods or services, the application should include a certification from the Registrar of Trade Marks in terms of the provision to Sub-Section (i) of Section 45 of the Copyright Act, 1957. : N.A.
15. If the work is an 'Artistic work', whether it is registered under the Designs Act 2000 if yes give details. : N.A.
16. If the work is an 'Artistic work', capable of being registered as a design under the Designs Act 2000, whether it has been applied to an article though an industrial process and ,if yes ,the number of times it is reproduced. : N.A.
17. F :



8830/2020-CO/L
01/07/2020
01/07/2020

DEPUTY REGISTRAR OF COPYRIGHTS



Dated : 15/09/2020

1. Registration Number : **L-94713/2020**
2. Name, address and nationality of the applicant : KRISHNA INSTITUTE OF MEDICAL SCIENCES "DEEMED TO BE UNIVERSITY", KARAD , KRISHNA INSTITUTE OF MEDICAL SCIENCES "DEEMED TO BE UNIVERSITY", KARAD, MALKAPUR, KARAD, DIST. SATARA, MAHARASHTRA, INDIA-415539 INDIAN
3. Nature of the applicant's interest in the copyright of the work : OWNER
4. Class and description of the work : LITERARY/ DRAMATIC WORK
5. Title of the work : DENTISTRY GAMIFIED
6. Language of the work : ENGLISH
7. Name, address and nationality of the author and if the author is deceased, date of his decease : DR. SUSHMA BOMMANAVAR , KRISHNA INSTITUTE OF MEDICAL SCIENCES "DEEMED TO BE UNIVERSITY", KARAD, MALKAPUR, KARAD, DIST. SATARA, MAHARASHTRA, INDIA-415539 INDIAN
8. Whether the work is published or unpublished : UNPUBLISHED
9. Year and country of first publication and name, address and nationality of the publisher : N.A.
10. Years and countries of subsequent publications, if any, and names, addresses and nationalities of the publishers : N.A.
11. Names, addresses and nationalities of the owners of various rights comprising the copyright in the work and the extent of rights held by each, together with particulars of assignments and licences, if any : KRISHNA INSTITUTE OF MEDICAL SCIENCES "DEEMED TO BE UNIVERSITY", KARAD , KRISHNA INSTITUTE OF MEDICAL SCIENCES "DEEMED TO BE UNIVERSITY", KARAD, MALKAPUR, KARAD, DIST. SATARA, MAHARASHTRA, INDIA-415539 INDIAN
12. Names, addresses and nationalities of other persons, if any, authorised to assign or licence of rights comprising the copyright : N.A.
13. If the work is an 'Artistic work', the location of the original work, including name, address and nationality of the person in possession of the work. (In the case of an architectural work, the year of completion of the work should also be shown). : N.A.
14. If the work is an 'Artistic work' which is used or capable of being used in relation to any goods or services, the application should include a certification from the Registrar of Trade Marks in terms of the provision to Sub-Section (i) of Section 45 of the Copyright Act, 1957. : N.A.
15. If the work is an 'Artistic work', whether it is registered under the Designs Act 2000 if yes give details. : N.A.
16. If the work is an 'Artistic work', capable of being registered as a design under the Designs Act 2000.whether it has been applied to an article though an industrial process and ,if yes ,the number of times it is reproduced. : N.A.
17. Remarks, if any :

Diary Number : 8833/2020-CO/L

Date : 01/07/2020

01/07/2020





DEPUTY REGISTRAR OF COPYRIGHTS



Dated : 30/07/2020

1. Registration Number : **L-93280/2020**
2. Name, address and nationality of the applicant : KRISHNA INSTITUTE OF MEDICAL SCIENCES "DEEMED TO BE UNIVERSITY", KARAD , KRISHNA INSTITUTE OF MEDICAL SCIENCES "DEEMED TO BE UNIVERSITY", KARAD, MALKAPUR, KARAD, DIST. SATARA, MAHARASHTRA, INDIA-415539 INDIAN
3. Nature of the applicant's interest in the copyright of the work : OWNER
4. Class and description of the work : LITERARY/ DRAMATIC WORK
5. Title of the work : MODIFIED JUGULOMETER
6. Language of the work : ENGLISH
7. Name, address and nationality of the author and if the author is deceased, date of his decease : DR. VIRENDRA CHANDRASHEKHAR PATIL , MD. MEDICINE, PROFESSOR, & HOD MEDICINE, KRISHNA INSTITUTE OF MEDICAL SCIENCES "DEEMED TO BE UNIVERSITY", KARAD, MALKAPUR, KARAD, DIST. SATARA, MAHARASHTRA, INDIA-415539 INDIAN
8. Whether the work is published or unpublished : UNPUBLISHED
9. Year and country of first publication and name, address and nationality of the publisher : N.A.
10. Years and countries of subsequent publications, if any, and names, addresses and nationalities of the publishers : N.A.
11. Names, addresses and nationalities of the owners of various rights comprising the copyright in the work and the extent of rights held by each, together with particulars of assignments and licences, if any : KRISHNA INSTITUTE OF MEDICAL SCIENCES "DEEMED TO BE UNIVERSITY", KARAD , KRISHNA INSTITUTE OF MEDICAL SCIENCES "DEEMED TO BE UNIVERSITY", KARAD, MALKAPUR, KARAD, DIST. SATARA, MAHARASHTRA, INDIA-415539 INDIAN
12. Names, addresses and nationalities of other persons, if any, authorised to assign or licence of rights comprising the copyright : N.A.
13. If the work is an 'Artistic work', the location of the original work, including name, address and nationality of the person in possession of the work. (In the case of an architectural work, the year of completion of the work should also be shown). : N.A.
14. If the work is an 'Artistic work' which is used or capable of being used in relation to any goods or services, the application should include a certification from the Registrar of Trade Marks in terms of the provision to Sub-Section (i) of Section 45 of the Copyright Act, 1957. : N.A.
15. If the work is an 'Artistic work', whether it is registered under the Designs Act 2000 if yes give details. : N.A.
16. If the work is an 'Artistic work', capable of being registered as a design under the Designs Act 2000.whether it has been applied to an article though an industrial process and ,if yes ,the number of times it is reproduced. : N.A.
17. Remarks, if any :

Diary No. 8087/2020-CO/L
Date 18/06/2020
18/06/2020



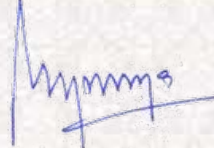

DEPUTY REGISTRAR OF COPYRIGHTS



Dated : 13/08/2020

1. Registration Number : **L-93518/2020**
2. Name, address and nationality of the applicant : KRISHNA INSTITUTE OF MEDICAL SCIENCES "DEEMED TO BE UNIVERSITY", KARAD , KRISHNA INSTITUTE OF MEDICAL SCIENCES "DEEMED TO BE UNIVERSITY", KARAD, MALKAPUR, KARAD, DIST. SATARA, MAHARASHTRA, INDIA-415539 INDIAN
3. Nature of the applicant's interest in the copyright of the work : OWNER
4. Class and description of the work : LITERARY/ DRAMATIC WORK
5. Title of the work : ACRONYM TABLE FOR SARS COV-2 OR CORONAVIRUS DISEASE (COVID-19)
6. Language of the work : ENGLISH
7. Name, address and nationality of the author and if the author is deceased, date of his decease : DR. VIRENDRA CHANDRASHEKHAR PATIL , KRISHNA INSTITUTE OF MEDICAL SCIENCES "DEEMED TO BE UNIVERSITY", KARAD, MALKAPUR, KARAD, DIST. SATARA, MAHARASHTRA, INDIA-415539 INDIAN
8. Whether the work is published or unpublished : UNPUBLISHED
9. Year and country of first publication and name, address and nationality of the publisher : N.A.
10. Years and countries of subsequent publications, if any, and names, addresses and nationalities of the publishers : N.A.
11. Names, addresses and nationalities of the owners of various rights comprising the copyright in the work and the extent of rights held by each, together with particulars of assignments and licences, if any : KRISHNA INSTITUTE OF MEDICAL SCIENCES "DEEMED TO BE UNIVERSITY", KARAD , KRISHNA INSTITUTE OF MEDICAL SCIENCES "DEEMED TO BE UNIVERSITY", KARAD, MALKAPUR, KARAD, DIST. SATARA, MAHARASHTRA, INDIA-415539 INDIAN
12. Names, addresses and nationalities of other persons, if any, authorised to assign or licence of rights comprising the copyright : N.A.
13. If the work is an 'Artistic work', the location of the original work, including name, address and nationality of the person in possession of the work. (In the case of an architectural work, the year of completion of the work should also be shown). : N.A.
14. If the work is an 'Artistic work' which is used or capable of being used in relation to any goods or services, the application should include a certification from the Registrar of Trade Marks in terms of the provision to Sub-Section (i) of Section 45 of the Copyright Act, 1957. : N.A.
15. If the work is an 'Artistic work', whether it is registered under the Designs Act 2000 if yes give details. : N.A.
16. If the work is an 'Artistic work', capable of being registered as a design under the Designs Act 2000.whether it has been applied to an article though an industrial process and ,if yes ,the number of times it is reproduced. : N.A.
17. Remarks, if any :

Diary No. 8829/2020-CO/L
Date 01/07/2020
01/07/2020



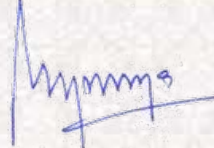

DEPUTY REGISTRAR OF COPYRIGHTS



Dated : 14/08/2020

1. Registration Number : **L-93551/2020**
2. Name, address and nationality of the applicant : KRISHNA INSTITUTE OF MEDICAL SCIENCES "DEEMED TO BE UNIVERSITY", KARAD , KRISHNA INSTITUTE OF MEDICAL SCIENCES "DEEMED TO BE UNIVERSITY", KARAD, MALKAPUR, KARAD, DIST. SATARA, MAHARASHTRA, INDIA-415539 INDIAN
3. Nature of the applicant's interest in the copyright of the work : OWNER
4. Class and description of the work : LITERARY/ DRAMATIC WORK
5. Title of the work : SURGEON'S PRAYER - TIMES WHEN I WEAR GLOVES
6. Language of the work : ENGLISH
7. Name, address and nationality of the author and if the author is deceased, date of his decease : DR. PRASHANT PUNDE , SCHOOL OF DENTAL SCIENCES, KRISHNA INSTITUTE OF MEDICAL SCIENCES DEEMED TO BE UNIVERSITY, KARAD, MALKAPUR, KARAD, DIST. SATARA-415539 INDIAN
8. Whether the work is published or unpublished : UNPUBLISHED
9. Year and country of first publication and name, address and nationality of the publisher : N.A.
10. Years and countries of subsequent publications, if any, and names, addresses and nationalities of the publishers : N.A.
11. Names, addresses and nationalities of the owners of various rights comprising the copyright in the work and the extent of rights held by each, together with particulars of assignments and licences, if any : KRISHNA INSTITUTE OF MEDICAL SCIENCES "DEEMED TO BE UNIVERSITY", KARAD , KRISHNA INSTITUTE OF MEDICAL SCIENCES "DEEMED TO BE UNIVERSITY", KARAD, MALKAPUR, KARAD, DIST. SATARA, MAHARASHTRA, INDIA-415539 INDIAN
12. Names, addresses and nationalities of other persons, if any, authorised to assign or licence of rights comprising the copyright : N.A.
13. If the work is an 'Artistic work', the location of the original work, including name, address and nationality of the person in possession of the work. (In the case of an architectural work, the year of completion of the work should also be shown). : N.A.
14. If the work is an 'Artistic work' which is used or capable of being used in relation to any goods or services, the application should include a certification from the Registrar of Trade Marks in terms of the provision to Sub-Section (i) of Section 45 of the Copyright Act, 1957. : N.A.
15. If the work is an 'Artistic work', whether it is registered under the Designs Act 2000 if yes give details. : N.A.
16. If the work is an 'Artistic work', capable of being registered as a design under the Designs Act 2000.whether it has been applied to an article though an industrial process and ,if yes ,the number of times it is reproduced. : N.A.
17. Remarks, if any :

Diary Number : 8626/2020-CO/L

Date : 27/06/2020

27/06/2020



DEPUTY REGISTRAR OF COPYRIGHTS



Dated : 19/08/2020

1. Registration Number : **L-93820/2020**
2. Name, address and nationality of the applicant : KRISHNA INSTITUTE OF MEDICAL SCIENCES "DEEMED TO BE UNIVERSITY", KARAD , KRISHNA INSTITUTE OF MEDICAL SCIENCES "DEEMED TO BE UNIVERSITY", KARAD, MALKAPUR, KARAD, DIST. SATARA, MAHARASHTRA, INDIA-415539
INDIAN
3. Nature of the applicant's interest in the copyright of the work : OWNER
4. Class and description of the work : LITERARY/ DRAMATIC WORK
5. Title of the work : DANTA CHIKITSA BAAHYA RUGNA CARD DWARA PLASTIC VIRODH ABHIYAN
6. Language of the work : MARATHI
7. Name, address and nationality of the author and if the author is deceased, date of his decease : DR. PRASHANT PUNDE , SCHOOL OF DENTAL SCIENCES, KRISHNA INSTITUTE OF MEDICAL SCIENCES DEEMED TO BE UNIVERSITY, KARAD, MALKAPUR, KARAD, DIST. SATARA-415539
INDIAN

DR. SHASHIKIRAN N. D. , SCHOOL OF DENTAL SCIENCES, KRISHNA INSTITUTE OF MEDICAL SCIENCES DEEMED TO BE UNIVERSITY, KARAD, MALKAPUR, KARAD, DIST. SATARA-415539
INDIAN

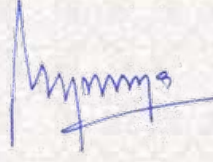
DR. ADISH SARAF , SCHOOL OF DENTAL SCIENCES, KRISHNA INSTITUTE OF MEDICAL SCIENCES DEEMED TO BE UNIVERSITY, KARAD, MALKAPUR, KARAD, DIST. SATARA-415539
INDIAN
8. Whether the work is published or unpublished : UNPUBLISHED
9. Year and country of first publication and name, address and nationality of the publisher : N.A.
10. Years and countries of subsequent publications, if any, and names, addresses and nationalities of the publishers : N.A.
11. Names, addresses and nationalities of the owners of various rights comprising the copyright in the work and the extent of rights held by each, together with particulars of assignments and licences, if any : KRISHNA INSTITUTE OF MEDICAL SCIENCES "DEEMED TO BE UNIVERSITY", KARAD , KRISHNA INSTITUTE OF MEDICAL SCIENCES "DEEMED TO BE UNIVERSITY", KARAD, MALKAPUR, KARAD, DIST. SATARA, MAHARASHTRA, INDIA-415539
INDIAN
12. Names, addresses and nationalities of other persons, if any, authorised to assign or licence of rights comprising the copyright : N.A.
13. If the work is an 'Artistic work', the location of the original work, including name, address and nationality of the person in possession of the work. (In the case of an architectural work, the year of completion of the work should also be shown). : N.A.
14. If the work is an 'Artistic work' which is used or capable of being used in relation to any goods or services, the application should include a certification from the Registrar of Trade Marks in terms of the provision to Sub-Section (i) of Section 45 of the Copyright Act, 1957. : N.A.
15. If the work is an 'Artistic work', whether it is registered under the Copyright Act, 1957, give details. : N.A.
16. If the work is an 'Artistic work', capable of being registered as a work under the Copyright Act 2000, whether it has been applied to an artistic process and, if yes, the number of times : N.A.
17. Registrar : 
DEPUTY REGISTRAR OF COPYRIGHTS

Diary Number : 8629/2020-CO/L

Date of Application : 27/06/2020

Date of Receipt : 27/06/2020





Dated : 19/08/2020

1. Registration Number : **L-93819/2020**
2. Name, address and nationality of the applicant : KRISHNA INSTITUTE OF MEDICAL SCIENCES "DEEMED TO BE UNIVERSITY", KARAD , KRISHNA INSTITUTE OF MEDICAL SCIENCES "DEEMED TO BE UNIVERSITY", KARAD, MALKAPUR, KARAD, DIST. SATARA, MAHARASHTRA, INDIA-415539
INDIAN
3. Nature of the applicant's interest in the copyright of the work : OWNER
4. Class and description of the work : LITERARY/ DRAMATIC WORK
5. Title of the work : DANTA CHIKITSA BAAHYA RUGNA CARD DWARA PAANI VACHAVA ABHIYAAN
6. Language of the work : MARATHI
7. Name, address and nationality of the author and if the author is deceased, date of his decease : DR. PRASHANT PUNDE , SCHOOL OF DENTAL SCIENCES, KRISHNA INSTITUTE OF MEDICAL SCIENCES DEEMED TO BE UNIVERSITY, KARAD, MALKAPUR, KARAD, DIST. SATARA-415539
INDIAN

DR. SHASHIKIRAN N. D. , SCHOOL OF DENTAL SCIENCES, KRISHNA INSTITUTE OF MEDICAL SCIENCES DEEMED TO BE UNIVERSITY, KARAD, MALKAPUR, KARAD, DIST. SATARA-415539
INDIAN

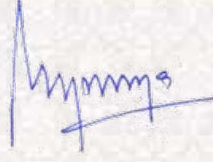
DR. PANKAJ PATIL , SCHOOL OF DENTAL SCIENCES, KRISHNA INSTITUTE OF MEDICAL SCIENCES DEEMED TO BE UNIVERSITY, KARAD, MALKAPUR, KARAD, DIST. SATARA-415539
INDIAN
8. Whether the work is published or unpublished : UNPUBLISHED
9. Year and country of first publication and name, address and nationality of the publisher : N.A.
10. Years and countries of subsequent publications, if any, and names, addresses and nationalities of the publishers : N.A.
11. Names, addresses and nationalities of the owners of various rights comprising the copyright in the work and the extent of rights held by each, together with particulars of assignments and licences, if any : KRISHNA INSTITUTE OF MEDICAL SCIENCES "DEEMED TO BE UNIVERSITY", KARAD , KRISHNA INSTITUTE OF MEDICAL SCIENCES "DEEMED TO BE UNIVERSITY", KARAD, MALKAPUR, KARAD, DIST. SATARA, MAHARASHTRA, INDIA-415539
INDIAN
12. Names, addresses and nationalities of other persons, if any, authorised to assign or licence of rights comprising the copyright : N.A.
13. If the work is an 'Artistic work', the location of the original work, including name, address and nationality of the person in possession of the work. (In the case of an architectural work, the year of completion of the work should also be shown). : N.A.
14. If the work is an 'Artistic work' which is used or capable of being used in relation to any goods or services, the application should include a certification from the Registrar of Trade Marks in terms of the provision to Sub-Section (i) of Section 45 of the Copyright Act, 1957. : N.A.
15. If the work is an 'Artistic work', whether it is registered under the Copyright Act, 1957, give details. : N.A.
16. If the work is an 'Artistic work', capable of being registered as a work under the Copyright Act 2000, whether it has been applied to an artistic process and, if yes, the number of times : N.A.
17. Registrar : 
DEPUTY REGISTRAR OF COPYRIGHTS

Diary Number : 8632/2020-CO/L

Date of Application : 27/06/2020

Date of Receipt : 27/06/2020





Dated : 13/08/2020

1. Registration Number : **L-93521/2020**
2. Name, address and nationality of the applicant : KRISHNA INSTITUTE OF MEDICAL SCIENCES "DEEMED TO BE UNIVERSITY", KARAD , KRISHNA INSTITUTE OF MEDICAL SCIENCES "DEEMED TO BE UNIVERSITY", KARAD, MALKAPUR, KARAD, DIST. SATARA, MAHARASHTRA, INDIA-415539 INDIAN
3. Nature of the applicant's interest in the copyright of the work : OWNER
4. Class and description of the work : LITERARY/ DRAMATIC WORK
5. Title of the work : DEVELOPMENT OF ANTI-VIRULENT FACE MASK TO DELIVER THE DISEASE COMBAT GIZMO FOR MEDICAL PRACTITIONERS AGAINST COVID-19 AND OTHER CONTAGIOUS DISEASES
6. Language of the work : ENGLISH
7. Name, address and nationality of the author and if the author is deceased, date of his decease : DR. JAYANT PAWAR , DIRECTORATE OF RESEARCH, KRISHNA INSTITUTE OF MEDICAL SCIENCES "DEEMED TO BE UNIVERSITY", KARAD, MALKAPUR, KARAD, DIST. SATARA, MAHARASHTRA, INDIA-415539 INDIAN
8. Whether the work is published or unpublished : UNPUBLISHED
9. Year and country of first publication and name, address and nationality of the publisher : N.A.
10. Years and countries of subsequent publications, if any, and names, addresses and nationalities of the publishers : N.A.
11. Names, addresses and nationalities of the owners of various rights comprising the copyright in the work and the extent of rights held by each, together with particulars of assignments and licences, if any : KRISHNA INSTITUTE OF MEDICAL SCIENCES "DEEMED TO BE UNIVERSITY", KARAD , KRISHNA INSTITUTE OF MEDICAL SCIENCES "DEEMED TO BE UNIVERSITY", KARAD, MALKAPUR, KARAD, DIST. SATARA, MAHARASHTRA, INDIA-415539 INDIAN
12. Names, addresses and nationalities of other persons, if any, authorised to assign or licence of rights comprising the copyright : N.A.
13. If the work is an 'Artistic work', the location of the original work, including name, address and nationality of the person in possession of the work. (In the case of an architectural work, the year of completion of the work should also be shown). : N.A.
14. If the work is an 'Artistic work' which is used or capable of being used in relation to any goods or services, the application should include a certification from the Registrar of Trade Marks in terms of the provision to Sub-Section (i) of Section 45 of the Copyright Act, 1957. : N.A.
15. If the work is an 'Artistic work', whether it is registered under the Designs Act 2000 if yes give details. : N.A.
16. If the work is an 'Artistic work', capable of being registered as a design under the Designs Act 2000, whether it has been applied to an article though an industrial process and ,if yes ,the number of times it is reproduced. : N.A.
17. F :



8822/2020-CO/L
01/07/2020
01/07/2020

DEPUTY REGISTRAR OF COPYRIGHTS



Dated : 19/08/2020

1. Registration Number : **L-93822/2020**
 2. Name, address and nationality of the applicant : KRISHNA INSTITUTE OF MEDICAL SCIENCES "DEEMED TO BE UNIVERSITY", KARAD , KRISHNA INSTITUTE OF MEDICAL SCIENCES "DEEMED TO BE UNIVERSITY", KARAD, MALKAPUR, KARAD, DIST. SATARA, MAHARASHTRA, INDIA-415539
INDIAN
 3. Nature of the applicant's interest in the copyright of the work : OWNER
 4. Class and description of the work : LITERARY/ DRAMATIC WORK
 5. Title of the work : ANTIBIOTICS AND DURATION OF DIARRHEA IN ANTIBIOTIC ASSOCIATED DIARRHEA (AAD)
 6. Language of the work : ENGLISH
 7. Name, address and nationality of the author and if the author is deceased, date of his decease : DR. PRIYANKA M. MANE , DEPARTMENT OF MICROBIOLOGY, KRISHNA INSTITUTE OF MEDICAL SCIENCES DEEMED TO BE UNIVERSITY, KARAD, MALKAPUR, KARAD, DIST. SATARA-415539
INDIAN

DR. SATISH R. PATIL , DEPARTMENT OF MICROBIOLOGY, KRISHNA INSTITUTE OF MEDICAL SCIENCES DEEMED TO BE UNIVERSITY, KARAD, MALKAPUR, KARAD, DIST. SATARA-415539
INDIAN

DR. MAKARAND B. MANE , DEPARTMENT OF MEDICINE, KRISHNA INSTITUTE OF MEDICAL SCIENCES DEEMED TO BE UNIVERSITY, KARAD, MALKAPUR, KARAD, DIST. SATARA-415539
INDIAN
 8. Whether the work is published or unpublished : UNPUBLISHED
 9. Year and country of first publication and name, address and nationality of the publisher : N.A.
 10. Years and countries of subsequent publications, if any, and names, addresses and nationalities of the publishers : N.A.
 11. Names, addresses and nationalities of the owners of various rights comprising the copyright in the work and the extent of rights held by each, together with particulars of assignments and licences, if any : KRISHNA INSTITUTE OF MEDICAL SCIENCES "DEEMED TO BE UNIVERSITY", KARAD , KRISHNA INSTITUTE OF MEDICAL SCIENCES "DEEMED TO BE UNIVERSITY", KARAD, MALKAPUR, KARAD, DIST. SATARA, MAHARASHTRA, INDIA-415539
INDIAN
 12. Names, addresses and nationalities of other persons, if any, authorised to assign or licence of rights comprising the copyright : N.A.
 13. If the work is an 'Artistic work', the location of the original work, including name, address and nationality of the person in possession of the work. (In the case of an architectural work, the year of completion of the work should also be shown). : N.A.
 14. If the work is an 'Artistic work' which is used or capable of being used in relation to any goods or services, the application should include a certification from the Registrar of Trade Marks in terms of the provision to Sub-Section (i) of Section 45 of the Copyright Act, 1957. : N.A.
 15. If the work is an 'Artistic work', whether it is registered under the Copyright Act, 1957, give details. : N.A.
 16. If the work is an 'Artistic work', capable of being registered as a work under the Copyright Act 2000, whether it has been applied to an industrial process and, if yes, the number of times : N.A.
 17. Registrar : 
DEPUTY REGISTRAR OF COPYRIGHTS
- Diary Number : 8623/2020-CO/L
Date of Application : 27/06/2020
Date of Receipt : 27/06/2020





Dated : 19/08/2020

1. Registration Number : **L-93783/2020**
2. Name, address and nationality of the applicant : KRISHNA INSTITUTE OF MEDICAL SCIENCES "DEEMED TO BE UNIVERSITY", KARAD , NH4, PUNE - BANGALORE HIGHWAY, DIST.SATARA, AGASHIVNAGAR, MALKAPUR, MAHARASHTRA-415539 INDIAN
3. Nature of the applicant's interest in the copyright of the work : OWNER
4. Class and description of the work : LITERARY/ DRAMATIC WORK
5. Title of the work : GENOTYPIC STUDY OF CARBAPENEM-RESISTANT A. BAUMANNII IN PATIENTS WITH VENTILATOR ASSOCIATED PNEUMONIA
6. Language of the work : ENGLISH
7. Name, address and nationality of the author and if the author is deceased, date of his decease : DR. HARSHA VIRENDRA PATIL , KRISHNA INSTITUTE OF MEDICAL SCIENCES "DEEMED TO BE UNIVERSITY", KARAD, NH4, PUNE - BANGALORE HIGHWAY, DIST.SATARA, AGASHIVNAGAR, MALKAPUR, MAHARASHTRA-415539 INDIAN
8. Whether the work is published or unpublished : UNPUBLISHED
9. Year and country of first publication and name, address and nationality of the publisher : N.A.
10. Years and countries of subsequent publications, if any, and names, addresses and nationalities of the publishers : N.A.
11. Names, addresses and nationalities of the owners of various rights comprising the copyright in the work and the extent of rights held by each, together with particulars of assignments and licences, if any : KRISHNA INSTITUTE OF MEDICAL SCIENCES "DEEMED TO BE UNIVERSITY", KARAD , NH4, PUNE - BANGALORE HIGHWAY, DIST.SATARA, AGASHIVNAGAR, MALKAPUR, MAHARASHTRA-415539 INDIAN
12. Names, addresses and nationalities of other persons, if any, authorised to assign or licence of rights comprising the copyright : KRISHNA INSTITUTE OF MEDICAL SCIENCES "DEEMED TO BE UNIVERSITY", KARAD , NH4, PUNE - BANGALORE HIGHWAY, DIST.SATARA, AGASHIVNAGAR, MALKAPUR, MAHARASHTRA-415539 INDIAN
13. If the work is an 'Artistic work', the location of the original work, including name, address and nationality of the person in possession of the work. (In the case of an architectural work, the year of completion of the work should also be shown). : N.A.
14. If the work is an 'Artistic work' which is used or capable of being used in relation to any goods or services, the application should include a certification from the Registrar of Trade Marks in terms of the provision to Sub-Section (i) of Section 45 of the Copyright Act, 1957. : N.A.
15. If the work is an 'Artistic work', whether it is registered under the Designs Act 2000 if yes give details. : N.A.
16. If the work is an 'Artistic work', capable of being registered as a design under the Designs Act 2000, whether it has been applied to an article, industrial process and ,if yes ,the number of times : N.A.
17. :



8554/2020-CO/L

26/06/2020

Date

26/06/2020

DEPUTY REGISTRAR OF COPYRIGHTS



Dated : 19/08/2020

1. Registration Number : **L-93782/2020**
2. Name, address and nationality of the applicant : KRISHNA INSTITUTE OF MEDICAL SCIENCES "DEEMED TO BE UNIVERSITY", KARAD , NH4, PUNE - BANGALORE HIGHWAY, DIST.SATARA, AGASHIVNAGAR, MALKAPUR, MAHARASHTRA-415539 INDIAN
3. Nature of the applicant's interest in the copyright of the work : OWNER
4. Class and description of the work : LITERARY/ DRAMATIC WORK
5. Title of the work : INTERSTATE INTERDISCIPLINARY CLINICO PATHOLOGICAL CONVENTION (IICPC)
6. Language of the work : ENGLISH
7. Name, address and nationality of the author and if the author is deceased, date of his decease : DR GIRISH SURAGIMATH , DEPARTMENT OF PERIODONTOLOGY, SCHOOL OF DENTAL SCIENCES, KRISHNA INSTITUTE OF MEDICAL SCIENCES "DEEMED TO BE UNIVERSITY", KARAD,NH4, PUNE - BANGALORE HIGHWAY, DIST.SATARA, AGASHIVNAGAR, MALKAPUR, MAH-415539 INDIAN
DR SHASHIKIRAN ND , DEPARTMENT OF PERIODONTOLOGY, SCHOOL OF DENTAL SCIENCES, KRISHNA INSTITUTE OF MEDICAL SCIENCES "DEEMED TO BE UNIVERSITY", KARAD,NH4, PUNE - BANGALORE HIGHWAY, DIST.SATARA, AGASHIVNAGAR, MALKAPUR, MAHA-415539 INDIAN
DR ASHWINI RANI SR , DEPARTMENT OF PERIODONTOLOGY, SCHOOL OF DENTAL SCIENCES, KRISHNA INSTITUTE OF MEDICAL SCIENCES "DEEMED TO BE UNIVERSITY", KARAD,NH4, PUNE - BANGALORE HIGHWAY, DIST.SATARA, AGASHIVNAGAR, MALKAPUR, MAHA-415539 INDIAN
8. Whether the work is published or unpublished : UNPUBLISHED
9. Year and country of first publication and name, address and nationality of the publisher : N.A.
10. Years and countries of subsequent publications, if any, and names, addresses and nationalities of the publishers : N.A.
11. Names, addresses and nationalities of the owners of various rights comprising the copyright in the work and the extent of rights held by each, together with particulars of assignments and licences, if any : KRISHNA INSTITUTE OF MEDICAL SCIENCES "DEEMED TO BE UNIVERSITY", KARAD , NH4, PUNE - BANGALORE HIGHWAY, DIST.SATARA, AGASHIVNAGAR, MALKAPUR, MAHARASHTRA-415539 INDIAN
12. Names, addresses and nationalities of other persons, if any, authorised to assign or licence of rights comprising the copyright : KRISHNA INSTITUTE OF MEDICAL SCIENCES "DEEMED TO BE UNIVERSITY", KARAD , NH4, PUNE - BANGALORE HIGHWAY, DIST.SATARA, AGASHIVNAGAR, MALKAPUR, MAHARASHTRA-415539 INDIAN
13. If the work is an 'Artistic work', the location of the original work, the name and nationality of the person in possession of the work, and if it is an architectural work, the year of construction (if any) should also be shown) : N.A.
14. If the work is a 'Literary work' which is used or capable of being used in connection with goods or services, the application should be made to the Registrar of Trade Marks in terms of sub-section (i) of Section 45 of the Copyright Act, 1957 : N.A.
15. If the work is an 'Artistic work', whether it is registered under the Designs Act 2000 if yes give details. : N.A.
16. If the work is an 'Artistic work', capable of being registered as a design under the Designs Act 2000.whether it has been applied to an article though an industrial process and ,if yes ,the number of times it is reproduced. : N.A.



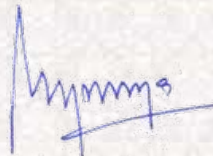

DEPUTY REGISTRAR OF COPYRIGHTS

17. Remarks, if any :

Diary Number :

8552/2020-CO/L

Date of Application :

26/06/2020

Date of Receipt :

26/06/2020



A handwritten signature in blue ink, appearing to be "M. M. M. S.", written over a faint rectangular stamp.

DEPUTY REGISTRAR OF COPYRIGHTS



Dated : 19/08/2020

1. Registration Number : **L-93786/2020**
2. Name, address and nationality of the applicant : KRISHNA INSTITUTE OF MEDICAL SCIENCES "DEEMED TO BE UNIVERSITY", KARAD , NH4, PUNE - BANGALORE HIGHWAY, DIST.SATARA, AGASHIVNAGAR, MALKAPUR, MAHARASHTRA-415539 INDIAN
3. Nature of the applicant's interest in the copyright of the work : OWNER
4. Class and description of the work : LITERARY/ DRAMATIC WORK
5. Title of the work : COVID PHYSIOTHERAPY ASSESSMENT FORMAT
6. Language of the work : ENGLISH
7. Name, address and nationality of the author and if the author is deceased, date of his decease :
RADHIKA CHINTAMANI , KRISHNA INSTITUTE OF MEDICAL SCIENCES; DEEMED TO BE UNIVERSITY, FACULTY OF PHYSIOTHERAPY KARAD, MAHARASHTRA, NH4, PUNE - BANGALORE HIGHWAY, DIST.SATARA, AGASHIVNAGAR, MALKAPUR, MAHARASHTRA-415539 INDIAN
MAYURI BURUNGALE , KRISHNA INSTITUTE OF MEDICAL SCIENCES; DEEMED TO BE UNIVERSITY, FACULTY OF PHYSIOTHERAPY KARAD, MAHARASHTRA, NH4, PUNE - BANGALORE HIGHWAY, DIST.SATARA, AGASHIVNAGAR, MALKAPUR, MAHARASHTRA-415539 INDIAN
G. VARADHARAJULU , KRISHNA INSTITUTE OF MEDICAL SCIENCES; DEEMED TO BE UNIVERSITY, FACULTY OF PHYSIOTHERAPY KARAD, MAHARASHTRA, NH4, PUNE - BANGALORE HIGHWAY, DIST.SATARA, AGASHIVNAGAR, MALKAPUR, MAHARASHTRA-415539 INDIAN
8. Whether the work is published or unpublished : UNPUBLISHED
9. Year and country of first publication and name, address and nationality of the publisher : N.A.
10. Years and countries of subsequent publications, if any, and names, addresses and nationalities of the publishers : N.A.
11. Names, addresses and nationalities of the owners of various rights comprising the copyright in the work and the extent of rights held by each, together with particulars of assignments and licences, if any : KRISHNA INSTITUTE OF MEDICAL SCIENCES "DEEMED TO BE UNIVERSITY", KARAD , NH4, PUNE - BANGALORE HIGHWAY, DIST.SATARA, AGASHIVNAGAR, MALKAPUR, MAHARASHTRA-415539 INDIAN
12. Names, addresses and nationalities of other persons, if any, authorised to assign or licence of rights comprising the copyright : KRISHNA INSTITUTE OF MEDICAL SCIENCES "DEEMED TO BE UNIVERSITY", KARAD , NH4, PUNE - BANGALORE HIGHWAY, DIST.SATARA, AGASHIVNAGAR, MALKAPUR, MAHARASHTRA-415539 INDIAN
13. If the work is an 'Artistic work', the location of the original work, including name, address and nationality of the person in possession of the work. (In the case of an architectural work, the year of completion of the work should also be shown). : N.A.
14. If the work is an 'Artistic work' which is used or capable of being used in connection with goods or services, the application should be made to the Registrar of Trade Marks in terms of Section (i) of Section 45 of the Copyright Act, : N.A.
15. If the work is an 'Artistic work', whether it is registered under the Designs Act 2000, give details. : N.A.
16. If the work is an 'Artistic work', capable of being registered as a design under the Designs Act 2000, whether it has been applied to an article though an industrial process and, if yes, the number of times it is reproduced. : N.A.
17. Remarks, if any :



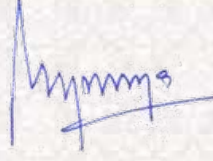

DEPUTY REGISTRAR OF COPYRIGHTS

Date of Application :

26/06/2020

Date of Receipt :

26/06/2020



A handwritten signature in blue ink, appearing to read "M. M. M. S.", is written over a faint rectangular stamp.

DEPUTY REGISTRAR OF COPYRIGHTS



Dated : 19/08/2020

1. Registration Number : **L-93788/2020**
2. Name, address and nationality of the applicant : KRISHNA INSTITUTE OF MEDICAL SCIENCES "DEEMED TO BE UNIVERSITY", KARAD , NH4, PUNE - BANGALORE HIGHWAY, DIST.SATARA, AGASHIVNAGAR, MALKAPUR, MAHARASHTRA-415539 INDIAN
3. Nature of the applicant's interest in the copyright of the work : OWNER
4. Class and description of the work : LITERARY/ DRAMATIC WORK
5. Title of the work : WALL OF RECOGNITION
6. Language of the work : ENGLISH
7. Name, address and nationality of the author and if the author is deceased, date of his decease : DR. SUSHMA.R , SCHOOL OF DENTAL SCIENCES KIMSDU KARAD,NH4, PUNE - BANGALORE HIGHWAY, DIST.SATARA, AGASHIVNAGAR, MALKAPUR, MAHARASHTRA-415539 INDIAN
DR. SHASHI KIRAN. N.D , SCHOOL OF DENTAL SCIENCES KIMSDU KARAD,NH4, PUNE - BANGALORE HIGHWAY, DIST.SATARA, AGASHIVNAGAR, MALKAPUR, MAHARASHTRA-415539 INDIAN
DR. PRASHANT PUNDE , SCHOOL OF DENTAL SCIENCES KIMSDU KARAD,NH4, PUNE - BANGALORE HIGHWAY, DIST.SATARA, AGASHIVNAGAR, MALKAPUR, MAHARASHTRA-415539 INDIAN
8. Whether the work is published or unpublished : UNPUBLISHED
9. Year and country of first publication and name, address and nationality of the publisher : N.A.
10. Years and countries of subsequent publications, if any, and names, addresses and nationalities of the publishers : N.A.
11. Names, addresses and nationalities of the owners of various rights comprising the copyright in the work and the extent of rights held by each, together with particulars of assignments and licences, if any : KRISHNA INSTITUTE OF MEDICAL SCIENCES "DEEMED TO BE UNIVERSITY", KARAD , NH4, PUNE - BANGALORE HIGHWAY, DIST.SATARA, AGASHIVNAGAR, MALKAPUR, MAHARASHTRA-415539 INDIAN
12. Names, addresses and nationalities of other persons, if any, authorised to assign or licence of rights comprising the copyright : KRISHNA INSTITUTE OF MEDICAL SCIENCES "DEEMED TO BE UNIVERSITY", KARAD , NH4, PUNE - BANGALORE HIGHWAY, DIST.SATARA, AGASHIVNAGAR, MALKAPUR, MAHARASHTRA-415539 INDIAN
13. If the work is an 'Artistic work', the location of the original work, including name, address and nationality of the person in possession of the work. (In the case of an architectural work, the year of completion of the work should also be shown). : N.A.
14. If the work is an 'Artistic work' which is used or capable of being used in connection with any goods or services, the application should be made to the Registrar of Trade Marks in terms of Section (i) of Section 45 of the Copyright Act, : N.A.
15. If the work is an 'Artistic work', whether it is registered under the Designs Act 2000, if yes, give details. : N.A.
16. If the work is an 'Artistic work', capable of being registered as a design under the Designs Act 2000, whether it has been applied to an article by an industrial process and, if yes, the number of times it is reproduced. : N.A.
17. Remarks, if any :

Diary Number : 8561/2020-CO/L

Date of Application : 26/06/2020

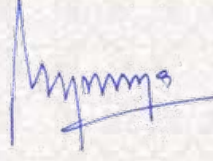
DEPUTY REGISTRAR OF COPYRIGHTS



A handwritten signature in blue ink, appearing to read "M. M. M. S.", is written over a faint rectangular stamp.

DEPUTY REGISTRAR OF COPYRIGHTS



Dated : 19/08/2020

1. Registration Number : **L-93781/2020**
2. Name, address and nationality of the applicant : KRISHNA INSTITUTE OF MEDICAL SCIENCES "DEEMED TO BE UNIVERSITY", KARAD , NH4, PUNE - BANGALORE HIGHWAY, DIST.SATARA, AGASHIVNAGAR, MALKAPUR, MAHARASHTRA-415539 INDIAN
3. Nature of the applicant's interest in the copyright of the work : OWNER
4. Class and description of the work : LITERARY/ DRAMATIC WORK
5. Title of the work : NOVEL METHOD OF LIFTING BASED ON KINESIOLOGICAL PRINCIPLES FOR STROKE PATIENTS
6. Language of the work : ENGLISH
7. Name, address and nationality of the author and if the author is deceased, date of his decease : DR. AKHILESH BIVALKAR , KRISHNA INSTITUTE OF MEDICAL SCIENCES "DEEMED TO BE UNIVERSITY", KARAD, NH4, PUNE - BANGALORE HIGHWAY, DIST.SATARA, AGASHIVNAGAR, MALKAPUR, MAHARASHTRA-415539 INDIAN
DR. G. VARADHARAJULU , KRISHNA INSTITUTE OF MEDICAL SCIENCES "DEEMED TO BE UNIVERSITY", KARAD, NH4, PUNE - BANGALORE HIGHWAY, DIST.SATARA, AGASHIVNAGAR, MALKAPUR, MAHARASHTRA-415539 INDIAN
8. Whether the work is published or unpublished : UNPUBLISHED
9. Year and country of first publication and name, address and nationality of the publisher : N.A.
10. Years and countries of subsequent publications, if any, and names, addresses and nationalities of the publishers : N.A.
11. Names, addresses and nationalities of the owners of various rights comprising the copyright in the work and the extent of rights held by each, together with particulars of assignments and licences, if any : KRISHNA INSTITUTE OF MEDICAL SCIENCES "DEEMED TO BE UNIVERSITY", KARAD , NH4, PUNE - BANGALORE HIGHWAY, DIST.SATARA, AGASHIVNAGAR, MALKAPUR, MAHARASHTRA-415539 INDIAN
12. Names, addresses and nationalities of other persons, if any, authorised to assign or licence of rights comprising the copyright : KRISHNA INSTITUTE OF MEDICAL SCIENCES "DEEMED TO BE UNIVERSITY", KARAD , NH4, PUNE - BANGALORE HIGHWAY, DIST.SATARA, AGASHIVNAGAR, MALKAPUR, MAHARASHTRA-415539 INDIAN
13. If the work is an 'Artistic work', the location of the original work, including name, address and nationality of the person in possession of the work. (In the case of an architectural work, the year of completion of the work should also be shown). : N.A.
14. If the work is an 'Artistic work' which is used or capable of being used in relation to any goods or services, the application should include a certification from the Registrar of Trade Marks in terms of the provision to Sub-Section (i) of Section 45 of the Copyright Act, 1957. : N.A.
15. If the work is an 'Artistic work', whether it is registered under the : N.A.
as give details.
16. If the work is an 'Artistic work', capable of being registered as a : N.A.
s Act 2000.whether it has been applied to an
rial process and ,if yes ,the number of times
17. Re :
Diary Number : 8550/2020-CO/L
Date of Application : 26/06/2020
Date of Receipt : 26/06/2020



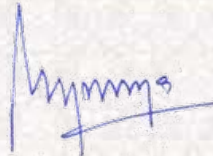

DEPUTY REGISTRAR OF COPYRIGHTS



Dated : 21/08/2020

1. Registration Number : **L-93905/2020**
 2. Name, address and nationality of the applicant : KRISHNA INSTITUTE OF MEDICAL SCIENCES "DEEMED TO BE UNIVERSITY", KARAD , KRISHNA INSTITUTE OF MEDICAL SCIENCES "DEEMED TO BE UNIVERSITY", KARAD-415539
INDIAN
 3. Nature of the applicant's interest in the copyright of the work : OWNER
 4. Class and description of the work : LITERARY/ DRAMATIC WORK
 5. Title of the work : DENTAL FAMILY MEET
 6. Language of the work : ENGLISH
 7. Name, address and nationality of the author and if the author is deceased, date of his decease : DR. PRASHANT PUNDE , SCHOOL OF DENTAL SCIENCES
KRISHNA INSTITUTE OF MEDICAL SCIENCES DEEMED TO BE UNIVERSITY-415539
INDIAN

DR. SHASHIKIRAN N.D. , SCHOOL OF DENTAL SCIENCES
KRISHNA INSTITUTE OF MEDICAL SCIENCES DEEMED TO BE UNIVERSITY-415539
INDIAN

DR. PANKAJ PATIL , SCHOOL OF DENTAL SCIENCES
KRISHNA INSTITUTE OF MEDICAL SCIENCES DEEMED TO BE UNIVERSITY-415539
INDIAN

DR. NAMRATA N. GAONKAR , SCHOOL OF DENTAL SCIENCES
KRISHNA INSTITUTE OF MEDICAL SCIENCES DEEMED TO BE UNIVERSITY-415539
INDIAN
 8. Whether the work is published or unpublished : UNPUBLISHED
 9. Year and country of first publication and name, address and nationality of the publisher : N.A.
 10. Years and countries of subsequent publications, if any, and names, addresses and nationalities of the publishers : N.A.
 11. Names, addresses and nationalities of the owners of various rights comprising the copyright in the work and the extent of rights held by each, together with particulars of assignments and licences, if any : KRISHNA INSTITUTE OF MEDICAL SCIENCES "DEEMED TO BE UNIVERSITY", KARAD , KRISHNA INSTITUTE OF MEDICAL SCIENCES "DEEMED TO BE UNIVERSITY", KARAD-415539
INDIAN
 12. Names, addresses and nationalities of other persons, if any, authorised to assign or licence of rights comprising the copyright : N.A.
 13. If the work is an 'Artistic work', the location of the original work, including name, address and nationality of the person in possession of the work. (In the case of an architectural work, the year of completion of the work should also be shown). : N.A.
 14. If the work is an 'Artistic work' which is used or capable of being used in relation to any goods or services, the application should include a certification from the Registrar of Trade Marks in terms of the provision to Sub-Section (i) of Section 45 of the Copyright Act, 1957. : N.A.
 15. If the work is an 'Artistic work', whether it is registered under the Copyright Act, 1957, give details. : N.A.
 16. If the work is an 'Artistic work', capable of being registered as a trademark under the Trademarks Act 2000, whether it has been applied to an article in the course of the registration process and, if yes, the number of times : N.A.
 17. : N.A.
- Diary : 8593/2020-CO/L
Date of Application : 27/06/2020
Date of Receipt : 27/06/2020



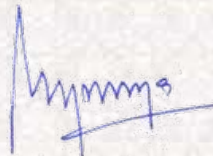

DEPUTY REGISTRAR OF COPYRIGHTS



Dated : 17/08/2020

1. Registration Number : **L-93634/2020**
2. Name, address and nationality of the applicant : KRISHNA INSTITUTE OF MEDICAL SCIENCES "DEEMED TO BE UNIVERSITY", KARAD , KRISHNA INSTITUTE OF MEDICAL SCIENCES "DEEMED TO BE UNIVERSITY", KARAD-415539
INDIAN
3. Nature of the applicant's interest in the copyright of the work : OWNER
4. Class and description of the work : LITERARY/ DRAMATIC WORK
5. Title of the work : DENTAL ACADEMIC PREMIER LEAGUE
6. Language of the work : ENGLISH
7. Name, address and nationality of the author and if the author is deceased, date of his decease : DR. PRASHANT PUNDE , SCHOOL OF DENTAL SCIENCES
KRISHNA INSTITUTE OF MEDICAL SCIENCES DEEMED TO BE UNIVERSITY
KARAD-415539
INDIAN

DR. SHASHIKIRAN. N.D , SCHOOL OF DENTAL SCIENCES
KRISHNA INSTITUTE OF MEDICAL SCIENCES DEEMED TO BE UNIVERSITY KARAD-415539
INDIAN

DR. MOUNESHKUMAR C.D. , SCHOOL OF DENTAL SCIENCES
KRISHNA INSTITUTE OF MEDICAL SCIENCES DEEMED TO BE UNIVERSITY KARAD-415539
INDIAN
8. Whether the work is published or unpublished : UNPUBLISHED
9. Year and country of first publication and name, address and nationality of the publisher : N.A.
10. Years and countries of subsequent publications, if any, and names, addresses and nationalities of the publishers : N.A.
11. Names, addresses and nationalities of the owners of various rights comprising the copyright in the work and the extent of rights held by each, together with particulars of assignments and licences, if any : KRISHNA INSTITUTE OF MEDICAL SCIENCES "DEEMED TO BE UNIVERSITY", KARAD , KRISHNA INSTITUTE OF MEDICAL SCIENCES "DEEMED TO BE UNIVERSITY", KARAD-415539
INDIAN
12. Names, addresses and nationalities of other persons, if any, authorised to assign or licence of rights comprising the copyright : N.A.
13. If the work is an 'Artistic work', the location of the original work, including name, address and nationality of the person in possession of the work. (In the case of an architectural work, the year of completion of the work should also be shown). : N.A.
14. If the work is an 'Artistic work' which is used or capable of being used in relation to any goods or services, the application should include a certification from the Registrar of Trade Marks in terms of the provision to Sub-Section (i) of Section 45 of the Copyright Act, 1957. : N.A.
15. If the work is an 'Artistic work', whether it is registered under the Designs Act 2000 if yes give details. : N.A.
16. If the work is an 'Artistic work', capable of being registered as a design under the Designs Act 2000, whether it has been applied to an article, if yes, the number of times : N.A.
17. :



8606/2020-CO/L

27/06/2020

Date of registration : 27/06/2020

DEPUTY REGISTRAR OF COPYRIGHTS



Dated : 17/08/2020

1. Registration Number : **L-93632/2020**
2. Name, address and nationality of the applicant : KRISHNA INSTITUTE OF MEDICAL SCIENCES "DEEMED TO BE UNIVERSITY", KARAD , KRISHNA INSTITUTE OF MEDICAL SCIENCES "DEEMED TO BE UNIVERSITY", KARAD-415539
INDIAN
3. Nature of the applicant's interest in the copyright of the work : OWNER
4. Class and description of the work : LITERARY/ DRAMATIC WORK
5. Title of the work : DENTAL ACADEMIC DEBATE PREMIER LEAGUE DADPL
6. Language of the work : ENGLISH
7. Name, address and nationality of the author and if the author is deceased, date of his decease : DR. PRASHANT PUNDE , SCHOOL OF DENTAL SCIENCES
KRISHNA INSTITUTE OF MEDICAL SCIENCES DEEMED TO BE UNIVERSITY, KARAD-415539
INDIAN

DR. SHASHIKIRAN. N.D , SCHOOL OF DENTAL SCIENCES
KRISHNA INSTITUTE OF MEDICAL SCIENCES DEEMED TO BE UNIVERSITY, KARAD-415539
INDIAN

DR. NAMRATA GAONKAR , SCHOOL OF DENTAL SCIENCES
KRISHNA INSTITUTE OF MEDICAL SCIENCES DEEMED TO BE UNIVERSITY-415539
INDIAN
8. Whether the work is published or unpublished : UNPUBLISHED
9. Year and country of first publication and name, address and nationality of the publisher : N.A.
10. Years and countries of subsequent publications, if any, and names, addresses and nationalities of the publishers : N.A.
11. Names, addresses and nationalities of the owners of various rights comprising the copyright in the work and the extent of rights held by each, together with particulars of assignments and licences, if any : KRISHNA INSTITUTE OF MEDICAL SCIENCES "DEEMED TO BE UNIVERSITY", KARAD , KRISHNA INSTITUTE OF MEDICAL SCIENCES "DEEMED TO BE UNIVERSITY", KARAD-415539
INDIAN
12. Names, addresses and nationalities of other persons, if any, authorised to assign or licence of rights comprising the copyright : N.A.
13. If the work is an 'Artistic work', the location of the original work, including name, address and nationality of the person in possession of the work. (In the case of an architectural work, the year of completion of the work should also be shown). : N.A.
14. If the work is an 'Artistic work' which is used or capable of being used in relation to any goods or services, the application should include a certification from the Registrar of Trade Marks in terms of the provision to Sub-Section (i) of Section 45 of the Copyright Act, 1957. : N.A.
15. If the work is an 'Artistic work', whether it is registered under the Designs Act 2000 if yes give details. : N.A.
16. If the work is an 'Artistic work', capable of being registered as a design under the Designs Act 2000, whether it has been applied to an article, or to an industrial process and ,if yes ,the number of times it has been so applied : N.A.
17. :



8602/2020-CO/L

27/06/2020

Date

27/06/2020

DEPUTY REGISTRAR OF COPYRIGHTS



Dated : 17/08/2020

1. Registration Number : **L-93638/2020**
2. Name, address and nationality of the applicant : KRISHNA INSTITUTE OF MEDICAL SCIENCES "DEEMED TO BE UNIVERSITY", KARAD , KRISHNA INSTITUTE OF MEDICAL SCIENCES "DEEMED TO BE UNIVERSITY", KARAD-415539 INDIAN
3. Nature of the applicant's interest in the copyright of the work : OWNER
4. Class and description of the work : LITERARY/ DRAMATIC WORK
5. Title of the work : DENTAL ACADEMIC SCIENTIFIC PREMIER LEAGUE
6. Language of the work : ENGLISH
7. Name, address and nationality of the author and if the author is deceased, date of his decease : DR. PRASHANT PUNDE , KRISHNA INSTITUTE OF MEDICAL SCIENCES "DEEMED TO BE UNIVERSITY", KARAD-415539 INDIAN
DR. SHASHIKIRAN. N.D , KRISHNA INSTITUTE OF MEDICAL SCIENCES "DEEMED TO BE UNIVERSITY", KARAD-415539 INDIAN
DR. SAMEER ZOPE , KRISHNA INSTITUTE OF MEDICAL SCIENCES "DEEMED TO BE UNIVERSITY", KARAD-415539 INDIAN
8. Whether the work is published or unpublished : UNPUBLISHED
9. Year and country of first publication and name, address and nationality of the publisher : N.A.
10. Years and countries of subsequent publications, if any, and names, addresses and nationalities of the publishers : N.A.
11. Names, addresses and nationalities of the owners of various rights comprising the copyright in the work and the extent of rights held by each, together with particulars of assignments and licences, if any : KRISHNA INSTITUTE OF MEDICAL SCIENCES "DEEMED TO BE UNIVERSITY", KARAD , KRISHNA INSTITUTE OF MEDICAL SCIENCES "DEEMED TO BE UNIVERSITY", KARAD-415539 INDIAN
12. Names, addresses and nationalities of other persons, if any, authorised to assign or licence of rights comprising the copyright : N.A.
13. If the work is an 'Artistic work', the location of the original work, including name, address and nationality of the person in possession of the work. (In the case of an architectural work, the year of completion of the work should also be shown). : N.A.
14. If the work is an 'Artistic work' which is used or capable of being used in relation to any goods or services, the application should include a certification from the Registrar of Trade Marks in terms of the provision to Sub-Section (i) of Section 45 of the Copyright Act, 1957. : N.A.
15. If the work is an 'Artistic work', whether it is registered under the Designs Act 2000 if yes give details. : N.A.
16. If the work is an 'Artistic work', capable of being registered as a design under the Designs Act 2000.whether it has been applied to an article used in an industrial process and ,if yes ,the number of times it is : N.A.
17. :



8617/2020-CO/L
27/06/2020
27/06/2020

DEPUTY REGISTRAR OF COPYRIGHTS



Dated : 17/08/2020

1. Registration Number : **L-93633/2020**
2. Name, address and nationality of the applicant : KRISHNA INSTITUTE OF MEDICAL SCIENCES "DEEMED TO BE UNIVERSITY", KARAD , KRISHNA INSTITUTE OF MEDICAL SCIENCES "DEEMED TO BE UNIVERSITY", KARAD-415539
INDIAN
3. Nature of the applicant's interest in the copyright of the work : OWNER
4. Class and description of the work : LITERARY/ DRAMATIC WORK DENTAL ACADEMIC PEDAGOGY PREMIER LEAGUE
5. Title of the work : DENTAL ACADEMIC PEDAGOGY PREMIER LEAGUE
6. Language of the work : ENGLISH
7. Name, address and nationality of the author and if the author is deceased, date of his decease : DR. PRASHANT PUNDE , SCHOOL OF DENTAL SCIENCES KRISHNA INSTITUTE OF MEDICAL SCIENCES DEEMED TO BE UNIVERSITY KARAD-415539
INDIAN

DR. SHASHIKIRAN. N.D , SCHOOL OF DENTAL SCIENCES KRISHNA INSTITUTE OF MEDICAL SCIENCES DEEMED TO BE UNIVERSITY KARAD-415539
INDIAN

DR. SUSHMA R. , SCHOOL OF DENTAL SCIENCES KRISHNA INSTITUTE OF MEDICAL SCIENCES DEEMED TO BE UNIVERSITY KARAD-415539
INDIAN
8. Whether the work is published or unpublished : UNPUBLISHED
9. Year and country of first publication and name, address and nationality of the publisher : N.A.
10. Years and countries of subsequent publications, if any, and names, addresses and nationalities of the publishers : N.A.
11. Names, addresses and nationalities of the owners of various rights comprising the copyright in the work and the extent of rights held by each, together with particulars of assignments and licences, if any : KRISHNA INSTITUTE OF MEDICAL SCIENCES "DEEMED TO BE UNIVERSITY", KARAD , KRISHNA INSTITUTE OF MEDICAL SCIENCES "DEEMED TO BE UNIVERSITY", KARAD-415539
INDIAN
12. Names, addresses and nationalities of other persons, if any, authorised to assign or licence of rights comprising the copyright : N.A.
13. If the work is an 'Artistic work', the location of the original work, including name, address and nationality of the person in possession of the work. (In the case of an architectural work, the year of completion of the work should also be shown). : N.A.
14. If the work is an 'Artistic work' which is used or capable of being used in relation to any goods or services, the application should include a certification from the Registrar of Trade Marks in terms of the provision to Sub-Section (i) of Section 45 of the Copyright Act, 1957. : N.A.
15. If the work is an 'Artistic work', whether it is registered under the Designs Act 2000 if yes give details. : N.A.
16. If the work is an 'Artistic work', capable of being registered as a design under the Designs Act 2000, whether it has been applied to an article, if yes, the number of times : N.A.

17. :
8604/2020-CO/L
27/06/2020
Date of : 27/06/2020



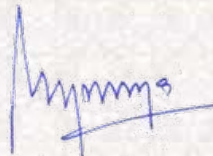

DEPUTY REGISTRAR OF COPYRIGHTS



Dated : 17/08/2020

1. Registration Number : **L-93636/2020**
2. Name, address and nationality of the applicant : KRISHNA INSTITUTE OF MEDICAL SCIENCES "DEEMED TO BE UNIVERSITY", KARAD , KRISHNA INSTITUTE OF MEDICAL SCIENCES "DEEMED TO BE UNIVERSITY", KARAD-415539
INDIAN
3. Nature of the applicant's interest in the copyright of the work : OWNER
4. Class and description of the work : LITERARY/ DRAMATIC WORK
5. Title of the work : DENTAL ACADEMIC RESEARCH PREMIER LEAGUE
6. Language of the work : ENGLISH
7. Name, address and nationality of the author and if the author is deceased, date of his decease : DR. PRASHANT PUNDE , SCHOOL OF DENTAL SCIENCES
KRISHNA INSTITUTE OF MEDICAL SCIENCES DEEMED TO BE UNIVERSITY
KARAD-415539
INDIAN

DR. SHASHIKIRAN. N.D , SCHOOL OF DENTAL SCIENCES
KRISHNA INSTITUTE OF MEDICAL SCIENCES DEEMED TO BE UNIVERSITY KARAD-415539
INDIAN

DR. SUSHMA R. , SCHOOL OF DENTAL SCIENCES KRISHNA
INSTITUTE OF MEDICAL SCIENCES DEEMED TO BE UNIVERSITY KARAD-415539
INDIAN
8. Whether the work is published or unpublished : UNPUBLISHED
9. Year and country of first publication and name, address and nationality of the publisher : N.A.
10. Years and countries of subsequent publications, if any, and names, addresses and nationalities of the publishers : N.A.
11. Names, addresses and nationalities of the owners of various rights comprising the copyright in the work and the extent of rights held by each, together with particulars of assignments and licences, if any : KRISHNA INSTITUTE OF MEDICAL SCIENCES "DEEMED TO BE UNIVERSITY", KARAD , KRISHNA INSTITUTE OF MEDICAL SCIENCES "DEEMED TO BE UNIVERSITY", KARAD-415539
INDIAN
12. Names, addresses and nationalities of other persons, if any, authorised to assign or licence of rights comprising the copyright : N.A.
13. If the work is an 'Artistic work', the location of the original work, including name, address and nationality of the person in possession of the work. (In the case of an architectural work, the year of completion of the work should also be shown). : N.A.
14. If the work is an 'Artistic work' which is used or capable of being used in relation to any goods or services, the application should include a certification from the Registrar of Trade Marks in terms of the provision to Sub-Section (i) of Section 45 of the Copyright Act, 1957. : N.A.
15. If the work is an 'Artistic work', whether it is registered under the Designs Act 2000 if yes give details. : N.A.
16. If the work is an 'Artistic work', capable of being registered as a design under the Designs Act 2000, whether it has been applied to an article, if yes, the number of times : N.A.
17. :



8615/2020-CO/L

27/06/2020

Date of registration : 27/06/2020

DEPUTY REGISTRAR OF COPYRIGHTS



Dated : 17/08/2020

1. Registration Number : **L-93639/2020**
2. Name, address and nationality of the applicant : KRISHNA INSTITUTE OF MEDICAL SCIENCES "DEEMED TO BE UNIVERSITY", KARAD , KRISHNA INSTITUTE OF MEDICAL SCIENCES "DEEMED TO BE UNIVERSITY", KARAD-415539
INDIAN
3. Nature of the applicant's interest in the copyright of the work : OWNER
4. Class and description of the work : LITERARY/ DRAMATIC WORK
5. Title of the work : DENTAL BADMINTON PREMIER LEAGUE
6. Language of the work : ENGLISH
7. Name, address and nationality of the author and if the author is deceased, date of his decease : DR. PRASHANT PUNDE , SCHOOL OF DENTAL SCIENCES
KRISHNA INSTITUTE OF MEDICAL SCIENCES DEEMED TO BE UNIVERSITY KARAD--415539
INDIAN

DR. SHASHIKIRAN. N.D , SCHOOL OF DENTAL SCIENCES
KRISHNA INSTITUTE OF MEDICAL SCIENCES DEEMED TO BE UNIVERSITY KARAD-415539
INDIAN

DR. SUSHMA.R. , SCHOOL OF DENTAL SCIENCES KRISHNA
INSTITUTE OF MEDICAL SCIENCES DEEMED TO BE UNIVERSITY KARAD-415539
INDIAN
8. Whether the work is published or unpublished : UNPUBLISHED
9. Year and country of first publication and name, address and nationality of the publisher : N.A.
10. Years and countries of subsequent publications, if any, and names, addresses and nationalities of the publishers : N.A.
11. Names, addresses and nationalities of the owners of various rights comprising the copyright in the work and the extent of rights held by each, together with particulars of assignments and licences, if any : KRISHNA INSTITUTE OF MEDICAL SCIENCES "DEEMED TO BE UNIVERSITY", KARAD , KRISHNA INSTITUTE OF MEDICAL SCIENCES "DEEMED TO BE UNIVERSITY", KARAD-415539
INDIAN
12. Names, addresses and nationalities of other persons, if any, authorised to assign or licence of rights comprising the copyright : N.A.
13. If the work is an 'Artistic work', the location of the original work, including name, address and nationality of the person in possession of the work. (In the case of an architectural work, the year of completion of the work should also be shown). : N.A.
14. If the work is an 'Artistic work' which is used or capable of being used in relation to any goods or services, the application should include a certification from the Registrar of Trade Marks in terms of the provision to Sub-Section (i) of Section 45 of the Copyright Act, 1957. : N.A.
15. If the work is an 'Artistic work', whether it is registered under the Designs Act 2000 if yes give details. : N.A.
16. If the work is an 'Artistic work', capable of being registered as a design under the Designs Act 2000, whether it has been applied to an article, or to an industrial process and ,if yes ,the number of times it has been so applied : N.A.
17. :



8619/2020-CO/L

27/06/2020

Date

27/06/2020

DEPUTY REGISTRAR OF COPYRIGHTS



Dated : 17/08/2020

1. Registration Number : **L-93635/2020**
2. Name, address and nationality of the applicant : KRISHNA INSTITUTE OF MEDICAL SCIENCES "DEEMED TO BE UNIVERSITY", KARAD , KRISHNA INSTITUTE OF MEDICAL SCIENCES "DEEMED TO BE UNIVERSITY", KARAD-415539
INDIAN
3. Nature of the applicant's interest in the copyright of the work : OWNER
4. Class and description of the work : LITERARY/ DRAMATIC WORK
5. Title of the work : DENTAL ACADEMIC QUIZ PREMIER LEAGUE
6. Language of the work : ENGLISH
7. Name, address and nationality of the author and if the author is deceased, date of his decease : DR. PRASHANT PUNDE , SCHOOL OF DENTAL SCIENCES
KRISHNA INSTITUTE OF MEDICAL SCIENCES DEEMED TO BE UNIVERSITY
KARAD-415539
INDIAN

DR. SHASHIKIRAN. N.D , SCHOOL OF DENTAL SCIENCES
KRISHNA INSTITUTE OF MEDICAL SCIENCES DEEMED TO BE UNIVERSITY KARAD-415539
INDIAN

DR. MOUNESHKUMAR C.D. , SCHOOL OF DENTAL SCIENCES
KRISHNA INSTITUTE OF MEDICAL SCIENCES DEEMED TO BE UNIVERSITY KARAD-415539
INDIAN
8. Whether the work is published or unpublished : UNPUBLISHED
9. Year and country of first publication and name, address and nationality of the publisher : N.A.
10. Years and countries of subsequent publications, if any, and names, addresses and nationalities of the publishers : N.A.
11. Names, addresses and nationalities of the owners of various rights comprising the copyright in the work and the extent of rights held by each, together with particulars of assignments and licences, if any : KRISHNA INSTITUTE OF MEDICAL SCIENCES "DEEMED TO BE UNIVERSITY", KARAD , KRISHNA INSTITUTE OF MEDICAL SCIENCES "DEEMED TO BE UNIVERSITY", KARAD-415539
INDIAN
12. Names, addresses and nationalities of other persons, if any, authorised to assign or licence of rights comprising the copyright : N.A.
13. If the work is an 'Artistic work', the location of the original work, including name, address and nationality of the person in possession of the work. (In the case of an architectural work, the year of completion of the work should also be shown). : N.A.
14. If the work is an 'Artistic work' which is used or capable of being used in relation to any goods or services, the application should include a certification from the Registrar of Trade Marks in terms of the provision to Sub-Section (i) of Section 45 of the Copyright Act, 1957. : N.A.
15. If the work is an 'Artistic work', whether it is registered under the Designs Act 2000 if yes give details. : N.A.
16. If the work is an 'Artistic work', capable of being registered as a design under the Designs Act 2000, whether it has been applied to an article, if yes, the number of times : N.A.
17. :



8613/2020-CO/L

27/06/2020

Date of registration : 27/06/2020

DEPUTY REGISTRAR OF COPYRIGHTS



Dated : 11/09/2020

1. Registration Number : **L-94626/2020**
2. Name, address and nationality of the applicant : KRISHNA INSTITUTE OF MEDICAL SCIENCES "DEEMED TO BE UNIVERSITY" KARAD , NEAR DHEBEWADI ROAD, PUNE BANGLORE NH NO.4, MALKAPUR, KARAD-415339 INDIAN
3. Nature of the applicant's interest in the copyright of the work : OWNER
4. Class and description of the work : LITERARY/ DRAMATIC WORK
5. Title of the work : RECENT SYSTEMATIC REVIEW ON USE OF SORAFENIB FORMULATION AS A POTENTIAL ANTI CANCER DRUG
6. Language of the work : ENGLISH
7. Name, address and nationality of the author and if the author is deceased, date of his decease : MRS.ANURADHA NIRANJAN CHIVATE , KIMSDU, NEAR DHEBEWADI ROAD, PUNE BANGLORE NH NO.4, MALKAPUR, KARAD-415339 INDIAN
8. Whether the work is published or unpublished : UNPUBLISHED
9. Year and country of first publication and name, address and nationality of the publisher : N.A.
10. Years and countries of subsequent publications, if any, and names, addresses and nationalities of the publishers : N.A.
11. Names, addresses and nationalities of the owners of various rights comprising the copyright in the work and the extent of rights held by each, together with particulars of assignments and licences, if any : KRISHNA INSTITUTE OF MEDICAL SCIENCES "DEEMED TO BE UNIVERSITY" KARAD , NEAR DHEBEWADI ROAD, PUNE BANGLORE NH NO.4, MALKAPUR, KARAD-415339 INDIAN
12. Names, addresses and nationalities of other persons, if any, authorised to assign or licence of rights comprising the copyright : N.A.
13. If the work is an 'Artistic work', the location of the original work, including name, address and nationality of the person in possession of the work. (In the case of an architectural work, the year of completion of the work should also be shown). : N.A.
14. If the work is an 'Artistic work' which is used or capable of being used in relation to any goods or services, the application should include a certification from the Registrar of Trade Marks in terms of the provision to Sub-Section (i) of Section 45 of the Copyright Act, 1957. : N.A.
15. If the work is an 'Artistic work', whether it is registered under the Designs Act 2000 if yes give details. : N.A.
16. If the work is an 'Artistic work', capable of being registered as a design under the Designs Act 2000.whether it has been applied to an article though an industrial process and ,if yes ,the number of times it is reproduced. : N.A.
17. Remarks, if any :

Diary Number : 9239/2020-CO/L

Date of Application : 08/07/2020

Date of Receipt : 08/07/2020



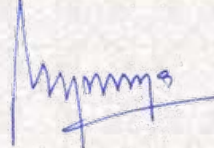

DEPUTY REGISTRAR OF COPYRIGHTS



Dated : 11/09/2020

1. Registration Number : **L-94627/2020**
2. Name, address and nationality of the applicant : KRISHNA INSTITUTE OF MEDICAL SCIENCES "DEEMED TO BE UNIVERSITY" KARAD , NEAR DHEBEWADI ROAD, PUNE BANGLORE NH NO.4, MALKAPUR, KARAD-415339 INDIAN
3. Nature of the applicant's interest in the copyright of the work : OWNER
4. Class and description of the work : LITERARY/ DRAMATIC WORK
5. Title of the work : PROCESS WITH STANDARDISED FLOW CHART FOR FORMULATION AND CHARACTERIZATION OF SELF EMULSIFYING DRUG DELIVERY SYSTEM.
6. Language of the work : ENGLISH
7. Name, address and nationality of the author and if the author is deceased, date of his decease : .NIRANJAN DATTATRYA CHIVATE , KIMSDU, NEAR DHEBEWADI ROAD, PUNE BANGLORE NH NO.4, MALKAPUR, KARAD-415339 INDIAN
8. Whether the work is published or unpublished : UNPUBLISHED
9. Year and country of first publication and name, address and nationality of the publisher : N.A.
10. Years and countries of subsequent publications, if any, and names, addresses and nationalities of the publishers : N.A.
11. Names, addresses and nationalities of the owners of various rights comprising the copyright in the work and the extent of rights held by each, together with particulars of assignments and licences, if any : KRISHNA INSTITUTE OF MEDICAL SCIENCES "DEEMED TO BE UNIVERSITY" KARAD , NEAR DHEBEWADI ROAD, PUNE BANGLORE NH NO.4, MALKAPUR, KARAD-415339 INDIAN
12. Names, addresses and nationalities of other persons, if any, authorised to assign or licence of rights comprising the copyright : N.A.
13. If the work is an 'Artistic work', the location of the original work, including name, address and nationality of the person in possession of the work. (In the case of an architectural work, the year of completion of the work should also be shown). : N.A.
14. If the work is an 'Artistic work' which is used or capable of being used in relation to any goods or services, the application should include a certification from the Registrar of Trade Marks in terms of the provision to Sub-Section (i) of Section 45 of the Copyright Act, 1957. : N.A.
15. If the work is an 'Artistic work', whether it is registered under the Designs Act 2000 if yes give details. : N.A.
16. If the work is an 'Artistic work', capable of being registered as a design under the Designs Act 2000.whether it has been applied to an article though an industrial process and ,if yes ,the number of times it is reproduced. : N.A.
17. Remarks, if any :

Diary Number : 9241/2020-CO/L

Date of Application : 08/07/2020

Date : 08/07/2020



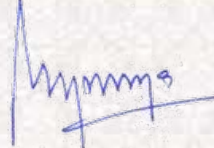

DEPUTY REGISTRAR OF COPYRIGHTS



Dated : 01/10/2020

1. Registration Number : **L-95258/2020**
2. Name, address and nationality of the applicant : KRISHNA INSTITUTE OF MEDICAL SCIENCES "DEEMED TO BE UNIVERSITY" KARAD , NEAR DHEBEWADI ROAD, PUNE BANGLORE NH NO.4, MALKAPUR, KARAD-415339 INDIAN
3. Nature of the applicant's interest in the copyright of the work : OWNER
4. Class and description of the work : LITERARY/ DRAMATIC WORK
5. Title of the work : TEACHING METHODOLOGY USING WHATSAPP APPLICATION DURING PANDEMIC SITUATION SUCH AS COVID-19 LOCKDOWN
6. Language of the work : ENGLISH
7. Name, address and nationality of the author and if the author is deceased, date of his decease : DR. GIRISH SURAGIMATH , MALKAPUR, KARAD DHEBEWADI, ROAD, KARAD-415339 INDIAN
8. Whether the work is published or unpublished : UNPUBLISHED
9. Year and country of first publication and name, address and nationality of the publisher : N.A.
10. Years and countries of subsequent publications, if any, and names, addresses and nationalities of the publishers : N.A.
11. Names, addresses and nationalities of the owners of various rights comprising the copyright in the work and the extent of rights held by each, together with particulars of assignments and licences, if any : KRISHNA INSTITUTE OF MEDICAL SCIENCES "DEEMED TO BE UNIVERSITY" KARAD , NEAR DHEBEWADI ROAD, PUNE BANGLORE NH NO.4, MALKAPUR, KARAD-415339 INDIAN
12. Names, addresses and nationalities of other persons, if any, authorised to assign or licence of rights comprising the copyright : N.A.
13. If the work is an 'Artistic work', the location of the original work, including name, address and nationality of the person in possession of the work. (In the case of an architectural work, the year of completion of the work should also be shown). : N.A.
14. If the work is an 'Artistic work' which is used or capable of being used in relation to any goods or services, the application should include a certification from the Registrar of Trade Marks in terms of the provision to Sub-Section (i) of Section 45 of the Copyright Act, 1957. : N.A.
15. If the work is an 'Artistic work', whether it is registered under the Designs Act 2000 if yes give details. : N.A.
16. If the work is an 'Artistic work', capable of being registered as a design under the Designs Act 2000.whether it has been applied to an article though an industrial process and ,if yes ,the number of times it is reproduced. : N.A.
17. Remarks, if any :

Diary Number : 9211/2020-CO/L

Date of Application : 07/07/2020

Date of Receipt : 07/07/2020



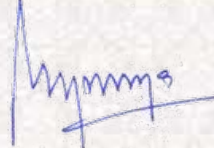

DEPUTY REGISTRAR OF COPYRIGHTS



Dated : 27/08/2020

1. Registration Number : **L-94150/2020**
2. Name, address and nationality of the applicant : KRISHNA INSTITUTE OF MEDICAL SCIENCES "DEEMED TO BE UNIVERSITY", KARAD , NH4, PUNE - BANGALORE HIGHWAY, DIST.SATARA, AGASHIVNAGAR, MALKAPUR, MAHARASHTRA-415539 INDIAN
3. Nature of the applicant's interest in the copyright of the work : OWNER
4. Class and description of the work : LITERARY/ DRAMATIC WORK
5. Title of the work : TALK FEST
6. Language of the work : ENGLISH
7. Name, address and nationality of the author and if the author is deceased, date of his decease : DR. NAMRATA GAONKAR , SCHOOL OF DENTAL SCIENCES KIMSDU KARAD-415539 INDIAN
DR. SHASHIKIRAN. N.D , SCHOOL OF DENTAL SCIENCES KIMSDU KARAD-415539 INDIAN
DR. PRERNA BARGE , SCHOOL OF DENTAL SCIENCES KIMSDU KARAD-415539 INDIAN
8. Whether the work is published or unpublished : UNPUBLISHED
9. Year and country of first publication and name, address and nationality of the publisher : N.A.
10. Years and countries of subsequent publications, if any, and names, addresses and nationalities of the publishers : N.A.
11. Names, addresses and nationalities of the owners of various rights comprising the copyright in the work and the extent of rights held by each, together with particulars of assignments and licences, if any : KRISHNA INSTITUTE OF MEDICAL SCIENCES "DEEMED TO BE UNIVERSITY", KARAD , NH4, PUNE - BANGALORE HIGHWAY, DIST.SATARA, AGASHIVNAGAR, MALKAPUR, MAHARASHTRA-415539 INDIAN
12. Names, addresses and nationalities of other persons, if any, authorised to assign or licence of rights comprising the copyright : KRISHNA INSTITUTE OF MEDICAL SCIENCES "DEEMED TO BE UNIVERSITY", KARAD , NH4, PUNE - BANGALORE HIGHWAY, DIST.SATARA, AGASHIVNAGAR, MALKAPUR, MAHARASHTRA-415539 INDIAN
13. If the work is an 'Artistic work', the location of the original work, including name, address and nationality of the person in possession of the work. (In the case of an architectural work, the year of completion of the work should also be shown). : N.A.
14. If the work is an 'Artistic work' which is used or capable of being used in relation to any goods or services, the application should include a certification from the Registrar of Trade Marks in terms of the provision to Sub-Section (i) of Section 45 of the Copyright Act, 1957. : N.A.
15. If the work is an 'Artistic work', whether it is registered under the Designs Act, 2000, if yes give details. : N.A.
16. If the work is an 'Artistic work', capable of being registered as a trademark under the Trademarks Act 2000, whether it has been applied to an article, the date of application, the date of registration, if any, and the date of the process and ,if yes ,the number of times : N.A.
17. :



Di : 9993/2020-CO/L
Date of Application : 21/07/2020
Date of Receipt : 21/07/2020

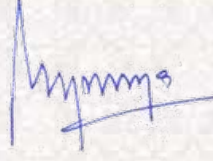

DEPUTY REGISTRAR OF COPYRIGHTS



Dated : 27/08/2020

1. Registration Number : **L-94151/2020**
2. Name, address and nationality of the applicant : KRISHNA INSTITUTE OF MEDICAL SCIENCES "DEEMED TO BE UNIVERSITY", KARAD , NH4, PUNE - BANGALORE HIGHWAY, DIST.SATARA, AGASHIVNAGAR, MALKAPUR, MAHARASHTRA-415539 INDIAN
3. Nature of the applicant's interest in the copyright of the work : OWNER
4. Class and description of the work : LITERARY/ DRAMATIC WORK
5. Title of the work : TWIST & RAISE WALKING TECHNIQUE FOR IMPROVING BREATHING QUALITY IN COVID 19 PATIENTS
6. Language of the work : ENGLISH
7. Name, address and nationality of the author and if the author is deceased, date of his decease : DR.PRASANNAJEET PRAMOD NIKAM , KRISHNA INSTITUTE OF MEDICAL SCIENCES DEEMED TO BE UNIVERSITY, NEAR DHEBEWADI ROAD, MALKAPUR TAL - KARAD. PIN - 415539 -415539 INDIAN
DR.G.VARADHARAJULU , KRISHNA INSTITUTE OF MEDICAL SCIENCES DEEMED TO BE UNIVERSITY, NEAR DHEBEWADI ROAD, MALKAPUR TAL - KARAD. PIN - 415539 DIST. - SATARA, MAHARASHTRA, INDIA-415539 INDIAN
8. Whether the work is published or unpublished : UNPUBLISHED
9. Year and country of first publication and name, address and nationality of the publisher : N.A.
10. Years and countries of subsequent publications, if any, and names, addresses and nationalities of the publishers : N.A.
11. Names, addresses and nationalities of the owners of various rights comprising the copyright in the work and the extent of rights held by each, together with particulars of assignments and licences, if any : KRISHNA INSTITUTE OF MEDICAL SCIENCES "DEEMED TO BE UNIVERSITY", KARAD , NH4, PUNE - BANGALORE HIGHWAY, DIST.SATARA, AGASHIVNAGAR, MALKAPUR, MAHARASHTRA-415539 INDIAN
12. Names, addresses and nationalities of other persons, if any, authorised to assign or licence of rights comprising the copyright : KRISHNA INSTITUTE OF MEDICAL SCIENCES "DEEMED TO BE UNIVERSITY", KARAD , NH4, PUNE - BANGALORE HIGHWAY, DIST.SATARA, AGASHIVNAGAR, MALKAPUR, MAHARASHTRA-415539 INDIAN
13. If the work is an 'Artistic work', the location of the original work, including name, address and nationality of the person in possession of the work. (In the case of an architectural work, the year of completion of the work should also be shown). : N.A.
14. If the work is an 'Artistic work' which is used or capable of being used in relation to any goods or services, the application should include a certification from the Registrar of Trade Marks in terms of the provision to Sub-Section (i) of Section 45 of the Copyright Act, 1957. : N.A.
15. If the work is an 'Artistic work', whether it is registered under the Copyright Act, 1957, give details. : N.A.
16. If the work is an 'Artistic work', capable of being registered as a trademark under the Trademarks Act 2000, whether it has been applied to an article, the date of application, the date of registration, if any, the date of the process and ,if yes ,the number of times : N.A.
17. If the work is an 'Artistic work', whether it is registered under the Copyright Act, 1957, give details. : N.A.

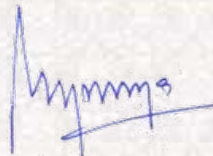



DEPUTY REGISTRAR OF COPYRIGHTS

Diary : 9996/2020-CO/L
Date of Application : 21/07/2020
Date of Receipt : 21/07/2020



Dated : 06/10/2020

1. Registration Number : **L-95429/2020**
2. Name, address and nationality of the applicant : KRISHNA INSTITUTE OF MEDICAL SCIENCES "DEEMED TO BE UNIVERSITY", KARAD , KRISHNA INSTITUTE OF MEDICAL SCIENCES "DEEMED TO BE UNIVERSITY", KARAD, MALKAPUR, KARAD, DIST. SATARA, MAHARASHTRA, INDIA-415539 INDIAN
3. Nature of the applicant's interest in the copyright of the work : OWNER
4. Class and description of the work : LITERARY/ DRAMATIC WORK
5. Title of the work : A REVIEW ON CLINICAL DATA MANAGEMENT IN CLINICAL TRIALS
6. Language of the work : ENGLISH
7. Name, address and nationality of the author and if the author is deceased, date of his decease : MRS. JISHA ANNIE GEEVARGHESE , KRISHNA INSTITUTE OF MEDICAL SCIENCES "DEEMED TO BE UNIVERSITY", KARAD, MALKAPUR, KARAD, DIST. SATARA, MAHARASHTRA, INDIA-415539 INDIAN
DR. RAJENDRA. C. DOJAD , KRISHNA INSTITUTE OF MEDICAL SCIENCES "DEEMED TO BE UNIVERSITY", KARAD, MALKAPUR, KARAD, DIST. SATARA, MAHARASHTRA, INDIA-415539 INDIAN
8. Whether the work is published or unpublished : UNPUBLISHED
9. Year and country of first publication and name, address and nationality of the publisher : N.A.
10. Years and countries of subsequent publications, if any, and names, addresses and nationalities of the publishers : N.A.
11. Names, addresses and nationalities of the owners of various rights comprising the copyright in the work and the extent of rights held by each, together with particulars of assignments and licences, if any : KRISHNA INSTITUTE OF MEDICAL SCIENCES "DEEMED TO BE UNIVERSITY", KARAD , KRISHNA INSTITUTE OF MEDICAL SCIENCES "DEEMED TO BE UNIVERSITY", KARAD, MALKAPUR, KARAD, DIST. SATARA, MAHARASHTRA, INDIA-415539 INDIAN
12. Names, addresses and nationalities of other persons, if any, authorised to assign or licence of rights comprising the copyright : N.A.
13. If the work is an 'Artistic work', the location of the original work, including name, address and nationality of the person in possession of the work. (In the case of an architectural work, the year of completion of the work should also be shown). : N.A.
14. If the work is an 'Artistic work' which is used or capable of being used in relation to any goods or services, the application should include a certification from the Registrar of Trade Marks in terms of the provision to Sub-Section (i) of Section 45 of the Copyright Act, 1957. : N.A.
15. If the work is an 'Artistic work', whether it is registered under the Designs Act 2000 if yes give details. : N.A.
16. If the work is an 'Artistic work', capable of being registered as a design under the Designs Act 2000, whether it has been applied to an article, or to an industrial process and ,if yes ,the number of times it has been so applied : N.A.
17. :



9334/2020-CO/L

09/07/2020

Date

09/07/2020



DEPUTY REGISTRAR OF COPYRIGHTS



Dated : 29/09/2020

- | | | |
|--|---|--|
| 1. Registration Number | : | L-95174/2020 |
| 2. Name, address and nationality of the applicant | : | KRISHNA INSTITUTE OF MEDICAL SCIENCES "DEEMED TO BE UNIVERSITY", KARAD , KRISHNA INSTITUTE OF MEDICAL SCIENCES "DEEMED TO BE UNIVERSITY", KARAD, MALKAPUR, KARAD, DIST. SATARA, MAHARASHTRA, INDIA-415539 INDIAN |
| 3. Nature of the applicant's interest in the copyright of the work | : | OWNER |
| 4. Class and description of the work | : | LITERARY/ DRAMATIC WORK |
| 5. Title of the work | : | DENTAL STUDENTS FOOD FESTIVAL (DENSFUFE) |
| 6. Language of the work | : | ENGLISH |
| 7. Name, address and nationality of the author and if the author is deceased, date of his decease | : | DR. PRASHANT PUNDE , SCHOOL OF DENTAL SCIENCES, KRISHNA INSTITUTE OF MEDICAL SCIENCES DEEMED TO BE UNIVERSITY, KARAD, MALKAPUR, KARAD, DIST. SATARA, MAHARASHTRA, INDIA-415539 INDIAN

DR. SHASHIKIRAN. N.D. , SCHOOL OF DENTAL SCIENCES, KRISHNA INSTITUTE OF MEDICAL SCIENCES DEEMED TO BE UNIVERSITY, KARAD, MALKAPUR, KARAD, DIST. SATARA, MAHARASHTRA, INDIA-415539 INDIAN

DR. SIDDHARTHA VARMA , SCHOOL OF DENTAL SCIENCES, KRISHNA INSTITUTE OF MEDICAL SCIENCES DEEMED TO BE UNIVERSITY, KARAD, MALKAPUR, KARAD, DIST. SATARA, MAHARASHTRA, INDIA-415539 INDIAN |
| 8. Whether the work is published or unpublished | : | UNPUBLISHED |
| 9. Year and country of first publication and name, address and nationality of the publisher | : | N.A. |
| 10. Years and countries of subsequent publications, if any, and names, addresses and nationalities of the publishers | : | N.A. |
| 11. Names, addresses and nationalities of the owners of various rights comprising the copyright in the work and the extent of rights held by each, together with particulars of assignments and licences, if any | : | KRISHNA INSTITUTE OF MEDICAL SCIENCES "DEEMED TO BE UNIVERSITY", KARAD , KRISHNA INSTITUTE OF MEDICAL SCIENCES "DEEMED TO BE UNIVERSITY", KARAD, MALKAPUR, KARAD, DIST. SATARA, MAHARASHTRA, INDIA-415539 INDIAN |
| 12. Names, addresses and nationalities of other persons, if any, authorised to assign or licence of rights comprising the copyright | : | N.A. |
| 13. If the work is an 'Artistic work', the location of the original work, including name, address and nationality of the person in possession of the work. (In the case of an architectural work, the year of completion of the work should also be shown). | : | N.A. |
| 14. If the work is an 'Artistic work' which is used or capable of being used in relation to any goods or services, the application should include a declaration from the Registrar of Trade Marks in terms of the proviso to Section (i) of Section 45 of the Copyright Act, 1957. | : | N.A. |
| 15. If the work is an 'Artistic work', whether it is registered under the Copyright Act, 1957, give details. | : | N.A. |
| 16. If the work is an 'Artistic work', capable of being registered as a trademark under the Trademarks Act 2000, whether it has been applied to an industrial process and ,if yes ,the number of times it is so applied. | : | N.A. |
| 17. Remarks, if any | : | |

Diary Number : 9391/2020-CO/L
Date of Application : 10/07/2020
Date of Receipt : 10/07/2020

DEPUTY REGISTRAR OF COPYRIGHTS



Dated : 29/09/2020

1. Registration Number : **L-95173/2020**
 2. Name, address and nationality of the applicant : KRISHNA INSTITUTE OF MEDICAL SCIENCES "DEEMED TO BE UNIVERSITY", KARAD, MALKAPUR, KARAD , KRISHNA INSTITUTE OF MEDICAL SCIENCES "DEEMED TO BE UNIVERSITY", KARAD, MALKAPUR, KARAD, DIST. SATARA, MAHARASHTRA, INDIA-415539 INDIAN
 3. Nature of the applicant's interest in the copyright of the work : OWNER
 4. Class and description of the work : LITERARY/ DRAMATIC WORK
 5. Title of the work : DENTAL STUDENTS ART FESTIVAL (DENSART)
 6. Language of the work : ENGLISH
 7. Name, address and nationality of the author and if the author is deceased, date of his decease : DR. PRASHANT PUNDE , SCHOOL OF DENTAL SCIENCES, KRISHNA INSTITUTE OF MEDICAL SCIENCES "DEEMED TO BE UNIVERSITY", KARAD, MALKAPUR, KARAD, DIST. SATARA, MAHARASHTRA, INDIA-415539 INDIAN
DR. SHASHIKIRAN. N.D. , SCHOOL OF DENTAL SCIENCES, KRISHNA INSTITUTE OF MEDICAL SCIENCES "DEEMED TO BE UNIVERSITY", KARAD, MALKAPUR, KARAD, DIST. SATARA, MAHARASHTRA, INDIA-415539 INDIAN
DR. KUMAR NILESH , SCHOOL OF DENTAL SCIENCES, KRISHNA INSTITUTE OF MEDICAL SCIENCES "DEEMED TO BE UNIVERSITY", KARAD, MALKAPUR, KARAD, DIST. SATARA, MAHARASHTRA, INDIA-415539 INDIAN
 8. Whether the work is published or unpublished : UNPUBLISHED
 9. Year and country of first publication and name, address and nationality of the publisher : N.A.
 10. Years and countries of subsequent publications, if any, and names, addresses and nationalities of the publishers : N.A.
 11. Names, addresses and nationalities of the owners of various rights comprising the copyright in the work and the extent of rights held by each, together with particulars of assignments and licences, if any : KRISHNA INSTITUTE OF MEDICAL SCIENCES "DEEMED TO BE UNIVERSITY", KARAD, MALKAPUR, KARAD , KRISHNA INSTITUTE OF MEDICAL SCIENCES "DEEMED TO BE UNIVERSITY", KARAD, MALKAPUR, KARAD, DIST. SATARA, MAHARASHTRA, INDIA-415539 INDIAN
 12. Names, addresses and nationalities of other persons, if any, authorised to assign or licence of rights comprising the copyright : N.A.
 13. If the work is an 'Artistic work', the location of the original work, including name, address and nationality of the person in possession of the work. (In the case of an architectural work, the year of completion of the work should also be shown). : N.A.
 14. If the work is an 'Artistic work' which is used or capable of being used in relation to any goods or services, the application should include a certification from the Registrar of Trade Marks in terms of the provision to Sub-Section (i) of Section 45 of the Copyright Act, 1957. : N.A.
 15. If the work is an 'Artistic work', whether it is registered under the Copyright Act, 1957, give details. : N.A.
 16. If the work is an 'Artistic work', capable of being registered as a work of art under the Copyright Act 2000, whether it has been applied to an article, and if yes, the number of times it has been so applied. : N.A.
 17. :
- Diary : 9399/2020-CO/L
Date of Application : 10/07/2020
Date of Receipt : 10/07/2020





DEPUTY REGISTRAR OF COPYRIGHTS



Dated : 28/09/2020

1. Registration Number : **L-95146/2020**
2. Name, address and nationality of the applicant : KRISHNA INSTITUTE OF MEDICAL SCIENCES DEEMED TO BE UNIVERSITY, KARAD, MAHARASHTRA , KRISHNA INSTITUTE OF MEDICAL SCIENCES DEEMED TO BE UNIVERSITY, NEAR DHEBEWADI ROAD, MALKAPUR TAL – KARAD. DIST. – SATARA, MAHARASHTRA, INDIA,- 415539 INDIAN
3. Nature of the applicant's interest in the copyright of the work : OWNER
4. Class and description of the work : LITERARY/ DRAMATIC WORK CLASSIFICATION OF GLYCOSIDES
5. Title of the work : CLASSIFICATION OF GLYCOSIDES
6. Language of the work : ENGLISH
7. Name, address and nationality of the author and if the author is deceased, date of his decease : MRS.PALLAVI SANTOSH KARANJE , DEPT OF PHARMACOGNOSY, KRISHNA INSTITUTE OF PHARMACY, KIMSDTU, KARAD.- 415539 INDIAN
DR. R.C. DOJAD , DEPT OF PHARMACOGNOSY, KRISHNA INSTITUTE OF PHARMACY, KIMSDTU, KARAD-415539 INDIAN
8. Whether the work is published or unpublished : UNPUBLISHED
9. Year and country of first publication and name, address and nationality of the publisher : N.A.
10. Years and countries of subsequent publications, if any, and names, addresses and nationalities of the publishers : N.A.
11. Names, addresses and nationalities of the owners of various rights comprising the copyright in the work and the extent of rights held by each, together with particulars of assignments and licences, if any : KRISHNA INSTITUTE OF MEDICAL SCIENCES DEEMED TO BE UNIVERSITY, KARAD, MAHARASHTRA , KRISHNA INSTITUTE OF MEDICAL SCIENCES DEEMED TO BE UNIVERSITY, NEAR DHEBEWADI ROAD, MALKAPUR TAL – KARAD. DIST. – SATARA, MAHARASHTRA, INDIA,- 415539 INDIAN
12. Names, addresses and nationalities of other persons, if any, authorised to assign or licence of rights comprising the copyright : N.A.
13. If the work is an 'Artistic work', the location of the original work, including name, address and nationality of the person in possession of the work. (In the case of an architectural work, the year of completion of the work should also be shown). : N.A.
14. If the work is an 'Artistic work' which is used or capable of being used in relation to any goods or services, the application should include a certification from the Registrar of Trade Marks in terms of the provision to Sub-Section (i) of Section 45 of the Copyright Act, 1957. : N.A.
15. If the work is an 'Artistic work', whether it is registered under the Designs Act 2000 if yes give details. : N.A.
16. If the work is an 'Artistic work', capable of being registered as a design under the Designs Act 2000, whether it has been applied to an industrial process and ,if yes ,the number of times : N.A.
17. :



9461/2020-CO/L

Date of Receipt : 11/07/2020

Date of Receipt : 11/07/2020

DEPUTY REGISTRAR OF COPYRIGHTS



Dated : 29/09/2020

1. Registration Number : **L-95178/2020**
2. Name, address and nationality of the applicant : KRISHNA INSTITUTE OF MEDICAL SCIENCES DEEMED TO BE UNIVERSITY, KARAD, MAHARASHTRA , KRISHNA INSTITUTE OF MEDICAL SCIENCES DEEMED TO BE UNIVERSITY, NEAR DHEBEWADI ROAD, MALKAPUR TAL – KARAD. DIST. – SATARA, MAHARASHTRA, INDIA,- 415539 INDIAN
3. Nature of the applicant's interest in the copyright of the work : OWNER
4. Class and description of the work : LITERARY/ DRAMATIC WORK SURVEY REPORT OF ANXIETY AMONG DENTAL TREATMENT OF PATIENTS IN RURAL AREAS
5. Title of the work : SURVEY REPORT OF ANXIETY AMONG DENTAL TREATMENT OF PATIENTS IN RURAL AREAS
6. Language of the work : ENGLISH
7. Name, address and nationality of the author and if the author is deceased, date of his decease : MR. MAHENDRA ALATE , STATISTICIAN, DIRECTORATE OF RESEARCH; KRISHNA INSTITUTE OF MEDICAL SCIENCES, DEEMED TO BE UNIVERSITYKARAD, MAHARASHTRA.-415539 INDIAN
MR. DHIRAJKUMAR MANE , STATISTICIAN, DIRECTORATE OF RESEARCH; KRISHNA INSTITUTE OF MEDICAL SCIENCES, DEEMED TO BE UNIVERSITYKARAD, MAHARASHTRA.-415539 INDIAN
8. Whether the work is published or unpublished : UNPUBLISHED
9. Year and country of first publication and name, address and nationality of the publisher : N.A.
10. Years and countries of subsequent publications, if any, and names, addresses and nationalities of the publishers : N.A.
11. Names, addresses and nationalities of the owners of various rights comprising the copyright in the work and the extent of rights held by each, together with particulars of assignments and licences, if any : KRISHNA INSTITUTE OF MEDICAL SCIENCES DEEMED TO BE UNIVERSITY, KARAD. MAHARASHTRA , KRISHNA INSTITUTE OF MEDICAL SCIENCES DEEMED TO BE UNIVERSITY, NEAR DHEBEWADI ROAD, MALKAPUR TAL – KARAD. DIST. – SATARA, MAHARASHTRA, INDIA,- 415539 INDIAN
12. Names, addresses and nationalities of other persons, if any, authorised to assign or licence of rights comprising the copyright : N.A.
13. If the work is an 'Artistic work', the location of the original work, including name, address and nationality of the person in possession of the work. (In the case of an architectural work, the year of completion of the work should also be shown). : N.A.
14. If the work is an 'Artistic work' which is used or capable of being used in relation to any goods or services, the application should include a certification from the Registrar of Trade Marks in terms of the provision to Sub-Section (i) of Section 45 of the Copyright Act, 1957. : N.A.
15. If the work is an 'Artistic work', whether it is registered under the Copyright Act, 1957, give details. : N.A.
16. If the work is an 'Artistic work', capable of being registered as a work under the Copyright Act 2000, whether it has been applied to an industrial process and ,if yes ,the number of times : N.A.
17. Registrar : 
DEPUTY REGISTRAR OF COPYRIGHTS

Diary Number : 9460/2020-CO/L

Date of Application : 11/07/2020

Date of Receipt : 11/07/2020





Dated : 12/10/2020

1. Registration Number : **L-95624/2020**
2. Name, address and nationality of the applicant : KRISHNA INSTITUTE OF MEDICAL SCIENCES "DEEMED TO BE UNIVERSITY" MALKAPUR, KARAD , KRISHNA INSTITUTE OF MEDICAL SCIENCES DEEMED TO BE UNIVERSITY, NEAR DHEBEWADI ROAD, MALKAPUR TAL – KARAD. DIST. – SATARA, MAHARASHTRA, INDIA,-415539 INDIAN
3. Nature of the applicant's interest in the copyright of the work : OWNER
4. Class and description of the work : LITERARY/ DRAMATIC WORK ROLE OF LINEAR MODEL IN STATISTICS / ADVANTAGE OF LINEAR STATISTICAL MODELS
5. Title of the work : ADVANTAGE OF LINEAR STATISTICAL MODELS
6. Language of the work : ENGLISH
7. Name, address and nationality of the author and if the author is deceased, date of his decease : MR. MAHENDRA ALATE , KRISHNA INSTITUTE OF MEDICAL SCIENCES DEEMED TO BE UNIVERSITY, NEAR DHEBEWADI ROAD, MALKAPUR TAL – KARAD. -415539 INDIAN
DR. S. V. KAKADE , KRISHNA INSTITUTE OF MEDICAL SCIENCES DEEMED TO BE UNIVERSITY, NEAR DHEBEWADI ROAD, MALKAPUR TAL – KARAD. -415539 INDIAN
MR. DHIRAJKUMAR A. MANE , KRISHNA INSTITUTE OF MEDICAL SCIENCES DEEMED TO BE UNIVERSITY, NEAR DHEBEWADI ROAD, MALKAPUR TAL – KARAD. DIST. – SATARA, MAHARASHTRA, INDIA-415539 INDIAN
8. Whether the work is published or unpublished : UNPUBLISHED
9. Year and country of first publication and name, address and nationality of the publisher : N.A.
10. Years and countries of subsequent publications, if any, and names, addresses and nationalities of the publishers : N.A.
11. Names, addresses and nationalities of the owners of various rights comprising the copyright in the work and the extent of rights held by each, together with particulars of assignments and licences, if any : KRISHNA INSTITUTE OF MEDICAL SCIENCES "DEEMED TO BE UNIVERSITY" MALKAPUR, KARAD , KRISHNA INSTITUTE OF MEDICAL SCIENCES DEEMED TO BE UNIVERSITY, NEAR DHEBEWADI ROAD, MALKAPUR TAL – KARAD. DIST. – SATARA, MAHARASHTRA, INDIA,-415539 INDIAN
12. Names, addresses and nationalities of other persons, if any, authorised to assign or licence of rights comprising the copyright : N.A.
13. If the work is an 'Artistic work', the location of the original work, including name, address and nationality of the person in possession of the work. (In the case of an architectural work, the year of completion of the work should also be shown). : N.A.
14. If the work is an 'Artistic work' which is used or capable of being used in connection with goods or services, the application should be filed with the Registrar of Trade Marks in terms of Section (i) of Section 45 of the Copyright Act, : N.A.
15. If the work is an 'Artistic work', whether it is registered under the Designs Act 2000, if yes, give details. : N.A.
16. If the work is an 'Artistic work', capable of being registered as a design under the Designs Act 2000, whether it has been applied to an article though an industrial process and, if yes, the number of times it is reproduced. : N.A.
17. Remarks, if any :

Diary Number : 9458/2020-CO/L

Date of Application : 11/07/2020

DEPUTY REGISTRAR OF COPYRIGHTS



A handwritten signature in blue ink, written in a cursive style, is positioned above the title of the Deputy Registrar of Copyrights.

DEPUTY REGISTRAR OF COPYRIGHTS



Dated : 06/10/2020

1. Registration Number : **L-95426/2020**
2. Name, address and nationality of the applicant : KRISHNA INSTITUTE OF MEDICAL SCIENCES "DEEMED TO BE UNIVERSITY", KARAD, MAHARASHTRA., KRISHNA INSTITUTE OF MEDICAL SCIENCES DEEMED TO BE UNIVERSITY, NEAR DHEBEWADI ROAD, MALKAPUR TAL - KARAD. DIST. - SATARA, MAHARASHTRA, INDIA,-415539 INDIAN
3. Nature of the applicant's interest in the copyright of the work : OWNER
4. Class and description of the work : LITERARY/ DRAMATIC WORK
5. Title of the work : RETROSPECTIVE DATA STUDY CHILD LABOR IN INDIA
6. Language of the work : ENGLISH
7. Name, address and nationality of the author and if the author is deceased, date of his decease : MR. DHIRAJKUMAR MANE , STATISTICIAN, DIRECTORATE OF RESEARCH; KRISHNA INSTITUTE OF MEDICAL SCIENCES, DEEMED TO BE UNIVERSITY KARAD, MAHARASHTRA.-415539 INDIAN
MR. MAHENDRA ALATE , STATISTICIAN, DIRECTORATE OF RESEARCH; KRISHNA INSTITUTE OF MEDICAL SCIENCES, DEEMED TO BE UNIVERSITY KARAD, MAHARASHTRA.-415539 INDIAN
8. Whether the work is published or unpublished : UNPUBLISHED
9. Year and country of first publication and name, address and nationality of the publisher : N.A.
10. Years and countries of subsequent publications, if any, and names, addresses and nationalities of the publishers : N.A.
11. Names, addresses and nationalities of the owners of various rights comprising the copyright in the work and the extent of rights held by each, together with particulars of assignments and licences, if any : KRISHNA INSTITUTE OF MEDICAL SCIENCES "DEEMED TO BE UNIVERSITY", KARAD, MAHARASHTRA., KRISHNA INSTITUTE OF MEDICAL SCIENCES DEEMED TO BE UNIVERSITY, NEAR DHEBEWADI ROAD, MALKAPUR TAL - KARAD. DIST. - SATARA, MAHARASHTRA, INDIA,-415539 INDIAN
12. Names, addresses and nationalities of other persons, if any, authorised to assign or licence of rights comprising the copyright : N.A.
13. If the work is an 'Artistic work', the location of the original work, including name, address and nationality of the person in possession of the work. (In the case of an architectural work, the year of completion of the work should also be shown). : N.A.
14. If the work is an 'Artistic work' which is used or capable of being used in relation to any goods or services, the application should include a certification from the Registrar of Trade Marks in terms of the provision to Sub-Section (i) of Section 45 of the Copyright Act, 1957. : N.A.
15. If the work is an 'Artistic work', whether it is registered under the Designs Act, 2000 if yes give details. : N.A.
16. If the work is an 'Artistic work', capable of being registered as a design under the Designs Act 2000.whether it has been applied to an article, the material process and ,if yes ,the number of times : N.A.
17. :



9448/2020-CO/L

Date of Registration : 11/07/2020

Date of Receipt : 11/07/2020



DEPUTY REGISTRAR OF COPYRIGHTS



Dated : 29/09/2020

1. Registration Number : **L-95170/2020**
2. Name, address and nationality of the applicant : KRISHNA INSTITUTE OF MEDICAL SCIENCES "DEEMED TO BE UNIVERSITY", KARAD , KRISHNA INSTITUTE OF MEDICAL SCIENCES "DEEMED TO BE UNIVERSITY", KARAD, MALKAPUR, KARAD, DIST. SATARA, MAHARASHTRA, INDIA-415539
INDIAN
3. Nature of the applicant's interest in the copyright of the work : OWNER
4. Class and description of the work : LITERARY/ DRAMATIC WORK
5. Title of the work : TOOLS TO ASSESS AND MONITOR PROGRESS OF SELF STUDY REPORT BY INTERNAL QUALITY ASSURANCE CELL OF KRISHNA INSTITUTE OF MEDICAL SCIENCES "DEEMED TO BE UNIVERSITY", KARAD, MAHARASHTRA
6. Language of the work : ENGLISH
7. Name, address and nationality of the author and if the author is deceased, date of his decease : DR. SATISH R. PATIL , QUALITY ASSURANCE CELL, KRISHNA INSTITUTE OF MEDICAL SCIENCES "DEEMED TO BE UNIVERSITY", KARAD, MALKAPUR, KARAD, DIST. SATARA, MAHARASHTRA, INDIA-415539
INDIAN

DR. SUPRIYA S. PATIL , DEPT OF COMMUNITY MEDICINE, KRISHNA INSTITUTE OF MEDICAL SCIENCES "DEEMED TO BE UNIVERSITY", KARAD, MALKAPUR, KARAD, DIST. SATARA, MAHARASHTRA, INDIA-415539
INDIAN
8. Whether the work is published or unpublished : UNPUBLISHED
9. Year and country of first publication and name, address and nationality of the publisher : N.A.
10. Years and countries of subsequent publications, if any, and names, addresses and nationalities of the publishers : N.A.
11. Names, addresses and nationalities of the owners of various rights comprising the copyright in the work and the extent of rights held by each, together with particulars of assignments and licences, if any : KRISHNA INSTITUTE OF MEDICAL SCIENCES "DEEMED TO BE UNIVERSITY", KARAD , KRISHNA INSTITUTE OF MEDICAL SCIENCES "DEEMED TO BE UNIVERSITY", KARAD, MALKAPUR, KARAD, DIST. SATARA, MAHARASHTRA, INDIA-415539
INDIAN
12. Names, addresses and nationalities of other persons, if any, authorised to assign or licence of rights comprising the copyright : N.A.
13. If the work is an 'Artistic work', the location of the original work, including name, address and nationality of the person in possession of the work. (In the case of an architectural work, the year of completion of the work should also be shown). : N.A.
14. If the work is an 'Artistic work' which is used or capable of being used in relation to any goods or services, the application should include a certification from the Registrar of Trade Marks in terms of the provision to Sub-Section (i) of Section 45 of the Copyright Act, 1957. : N.A.
15. If the work is an 'Artistic work', whether it is registered under the Designs Act 2000 if yes give details. : N.A.
16. If the work is an 'Artistic work', capable of being registered as a design under the Designs Act 2000, whether it has been applied to an article, the date of application, the date of registration, if any, the date of the design process and ,if yes ,the number of times : N.A.
17. :



9809/2020-CO/L

Date of Receipt : 17/07/2020

Date of Receipt : 17/07/2020

DEPUTY REGISTRAR OF COPYRIGHTS



Dated : 15/09/2020

1. Registration Number : **L-94690/2020**
2. Name, address and nationality of the applicant : KRISHNA INSTITUTE OF MEDICAL SCIENCES "DEEMED TO BE UNIVERSITY", KARAD , KRISHNA INSTITUTE OF MEDICAL SCIENCES "DEEMED TO BE UNIVERSITY", KARAD, MALKAPUR, DIST. SATARA, MAHARASHTRA, INDIA-415539 INDIAN
3. Nature of the applicant's interest in the copyright of the work : OWNER
4. Class and description of the work : LITERARY/ DRAMATIC WORK PROCEDURE FOR MENTAL HEALTH CARE IN MARATHI FOR HEALTH WORKERS DURING COVID 19 PANDEMIC PERIOD
5. Title of the work : PRATHAMIK MANASIK UPACHAR TANTRE (AAROGYA KARMACHARI YANCHESAATHI) - COVID-19 MAHAMARI KALAT AAPLYA MANASIK AAROGYACHI KALAJI KASHI GHYAL?
6. Language of the work : MARATHI
7. Name, address and nationality of the author and if the author is deceased, date of his decease : MRS. VAISHALI YADAV , DEPARTMENT OF PSYCHIATRY, KRISHNA INSTITUTE OF MEDICAL SCIENCES "DEEMED TO BE UNIVERSITY", KARAD, MALKAPUR, DIST. SATARA, MAHARASHTRA, INDIA-415539 INDIAN
MRS. SHUBHANGI JAMALE , DEPARTMENT OF PSYCHIATRY, KRISHNA INSTITUTE OF MEDICAL SCIENCES "DEEMED TO BE UNIVERSITY", KARAD, MALKAPUR, DIST. SATARA, MAHARASHTRA, INDIA-415539 INDIAN
DR. AJISH MANGOT , DEPARTMENT OF PSYCHIATRY, KRISHNA INSTITUTE OF MEDICAL SCIENCES "DEEMED TO BE UNIVERSITY", KARAD, MALKAPUR, DIST. SATARA, MAHARASHTRA, INDIA-415539 INDIAN
DR. VASANTMEGHNA MURTHY , DEPARTMENT OF PSYCHIATRY, KRISHNA INSTITUTE OF MEDICAL SCIENCES "DEEMED TO BE UNIVERSITY", KARAD, MALKAPUR, DIST. SATARA, MAHARASHTRA, INDIA-415539 INDIAN
8. Whether the work is published or unpublished : UNPUBLISHED
9. Year and country of first publication and name, address and nationality of the publisher : N.A.
10. Years and countries of subsequent publications, if any, and names, addresses and nationalities of the publishers : N.A.
11. Names, addresses and nationalities of the owners of various rights comprising the copyright in the work and the extent of rights held by each, together with particulars of assignments and licences, if any : KRISHNA INSTITUTE OF MEDICAL SCIENCES "DEEMED TO BE UNIVERSITY", KARAD , KRISHNA INSTITUTE OF MEDICAL SCIENCES "DEEMED TO BE UNIVERSITY", KARAD, MALKAPUR, DIST. SATARA, MAHARASHTRA, INDIA-415539 INDIAN
12. Nationalities of other persons, if any, and the extent of rights comprising the copyright : N.A.
13. If the work is an 'Artistic work', the location of the original work, the name and nationality of the person in possession of the work, and if the work is an architectural work, the year of construction (if any) should also be shown). : N.A.
14. If the work is an 'Artistic work' which is used or capable of being used in relation to any goods or services, the application should include a certification from the Registrar of Trade Marks in terms of the provision to Sub-Section (i) of Section 45 of the Copyright Act, 1957. : N.A.
15. If the work is an 'Artistic work', whether it is registered under the Designs Act 2000 if yes give details. : N.A.





DEPUTY REGISTRAR OF COPYRIGHTS

16. If the work is an 'Artistic work', capable of being registered as a : N.A.
design under the Designs Act 2000.whether it has been applied to an
article though an industrial process and ,if yes ,the number of times
it is reproduced.

17. Remarks, if any :

Diary Number : 9765/2020-CO/L

Date of Application : 16/07/2020

Date of Receipt : 16/07/2020



A handwritten signature in blue ink, written in a cursive style, is positioned above the title of the official.

DEPUTY REGISTRAR OF COPYRIGHTS



Dated : 29/09/2020

1. Registration Number : **L-95171/2020**
2. Name, address and nationality of the applicant : KRISHNA INSTITUTE OF MEDICAL SCIENCES "DEEMED TO BE UNIVERSITY", KARAD , KRISHNA INSTITUTE OF MEDICAL SCIENCES "DEEMED TO BE UNIVERSITY", KARAD, MALKAPUR, DIST. SATARA, MAHARASHTRA, INDIA-415539 INDIAN
3. Nature of the applicant's interest in the copyright of the work : OWNER
4. Class and description of the work : LITERARY/ DRAMATIC WORK
5. Title of the work : PRATHAMIK MANASIK UPACHAR TANTRE (RUGNA AANI NATEVAIKANSAATHI) - COVID -19 MAHAMARI KALAT AAPLYA MANASIK AAROgyACHI KALAJI KASHI GHYAL
6. Language of the work : MARATHI
7. Name, address and nationality of the author and if the author is deceased, date of his decease : MRS. SHUBHANGI JAMALE , DEPARTMENT OF PSYCHIATRY, KRISHNA INSTITUTE OF MEDICAL SCIENCES "DEEMED TO BE UNIVERSITY", KARAD, MALKAPUR, DIST. SATARA, MAHARASHTRA, INDIA-415539 INDIAN
MRS. VAISHALI YADAV , DEPARTMENT OF PSYCHIATRY, KRISHNA INSTITUTE OF MEDICAL SCIENCES "DEEMED TO BE UNIVERSITY", KARAD, MALKAPUR, DIST. SATARA, MAHARASHTRA, INDIA-415539 INDIAN
DR. AJISH MANGOT , DEPARTMENT OF PSYCHIATRY, KRISHNA INSTITUTE OF MEDICAL SCIENCES "DEEMED TO BE UNIVERSITY", KARAD, MALKAPUR, DIST. SATARA, MAHARASHTRA, INDIA-415539 INDIAN
DR. VASANTMEGHNA MURTHY , DEPARTMENT OF PSYCHIATRY, KRISHNA INSTITUTE OF MEDICAL SCIENCES "DEEMED TO BE UNIVERSITY", KARAD, MALKAPUR, DIST. SATARA, MAHARASHTRA, INDIA-415539 INDIAN
8. Whether the work is published or unpublished : UNPUBLISHED
9. Year and country of first publication and name, address and nationality of the publisher : N.A.
10. Years and countries of subsequent publications, if any, and names, addresses and nationalities of the publishers : N.A.
11. Names, addresses and nationalities of the owners of various rights comprising the copyright in the work and the extent of rights held by each, together with particulars of assignments and licences, if any : KRISHNA INSTITUTE OF MEDICAL SCIENCES "DEEMED TO BE UNIVERSITY", KARAD , KRISHNA INSTITUTE OF MEDICAL SCIENCES "DEEMED TO BE UNIVERSITY", KARAD, MALKAPUR, DIST. SATARA, MAHARASHTRA, INDIA-415539 INDIAN
12. Names, addresses and nationalities of other persons, if any, authorised to assign or licence of rights comprising the copyright : N.A.
13. If the work is an 'Artistic work', the location of the original work, names and nationality of the person in possession of an architectural work, the year of construction (if any) should also be shown). : N.A.
14. If the work is an 'Artistic work' which is used or capable of being used in goods or services, the application should be filed from the Registrar of Trade Marks in terms of the Trade Marks Act, 1999-Section (i) of Section 45 of the Copyright Act, 1957. : N.A.
15. If the work is an 'Artistic work', whether it is registered under the Designs Act 2000 if yes give details. : N.A.
16. If the work is an 'Artistic work', capable of being registered as a design under the Designs Act 2000, whether it has been applied to an article though an industrial process and, if yes, the number of times it is reproduced. : N.A.





DEPUTY REGISTRAR OF COPYRIGHTS

17. Remarks, if any :

Diary Number : 9802/2020-CO/L

Date of Application : 17/07/2020

Date of Receipt : 17/07/2020



A handwritten signature in blue ink, written in a cursive style, is positioned above the printed name of the Deputy Registrar of Copyrights.

DEPUTY REGISTRAR OF COPYRIGHTS



Dated : 21/09/2020

1. Registration Number : **L-94898/2020**
2. Name, address and nationality of the applicant : KRISHNA INSTITUTE OF MEDICAL SCIENCES "DEEMED TO BE UNIVERSITY" KARAD , KRISHNA INSTITUTE OF PHARMACY, KARAD, NEAR DHEBEWADI ROAD, MALKAPUR, TAL – KARAD. DIST. – SATARA, MAHARASHTRA, INDIA-415539 INDIAN
3. Nature of the applicant's interest in the copyright of the work : OWNER
4. Class and description of the work : LITERARY/ DRAMATIC WORK
5. Title of the work : QUANTITATIVE STRUCTURE PROPERTY RELATIONSHIP
6. Language of the work : ENGLISH
7. Name, address and nationality of the author and if the author is deceased, date of his decease : VISHAL VILAS SHAH , DEPARTMENT OF PHARMACEUTICAL CHEMISTRY, KRISHNA INSTITUTE OF PHARMACY, KARAD, NEAR DHEBEWADI ROAD, MALKAPUR, TAL – KARAD., DIST. – SATARA, MAHARASHTRA, INDIA-415539 INDIAN
R. C. DOJAD , DEPARTMENT OF PHARMACEUTICAL CHEMISTRY, KRISHNA INSTITUTE OF PHARMACY, KARAD, NEAR DHEBEWADI ROAD, MALKAPUR, TAL – KARAD., DIST. – SATARA, MAHARASHTRA, INDIA-415539 INDIAN
8. Whether the work is published or unpublished : UNPUBLISHED
9. Year and country of first publication and name, address and nationality of the publisher : N.A.
10. Years and countries of subsequent publications, if any, and names, addresses and nationalities of the publishers : N.A.
11. Names, addresses and nationalities of the owners of various rights comprising the copyright in the work and the extent of rights held by each, together with particulars of assignments and licences, if any : KRISHNA INSTITUTE OF MEDICAL SCIENCES "DEEMED TO BE UNIVERSITY" KARAD , KRISHNA INSTITUTE OF PHARMACY, KARAD, NEAR DHEBEWADI ROAD, MALKAPUR, TAL – KARAD. DIST. – SATARA, MAHARASHTRA, INDIA-415539 INDIAN
12. Names, addresses and nationalities of other persons, if any, authorised to assign or licence of rights comprising the copyright : N.A.
13. If the work is an 'Artistic work', the location of the original work, including name, address and nationality of the person in possession of the work. (In the case of an architectural work, the year of completion of the work should also be shown). : N.A.
14. If the work is an 'Artistic work' which is used or capable of being used in relation to any goods or services, the application should include a certification from the Registrar of Trade Marks in terms of the provision to Sub-Section (i) of Section 45 of the Copyright Act, 1957. : N.A.
15. If the work is an 'Artistic work', whether it is registered under the Designs Act 2000 if yes give details. : N.A.
16. If the work is an 'Artistic work', capable of being registered as a design under the Designs Act 2000, whether it has been applied to an article, or to an industrial process and ,if yes ,the number of times it has been so applied : N.A.
17. :



10774/2020-CO/L

04/08/2020

Date

04/08/2020



DEPUTY REGISTRAR OF COPYRIGHTS



Dated : 23/09/2020

1. Registration Number : **L-94958/2020**
2. Name, address and nationality of the applicant : SCHOOL OF DENTAL SCIENCES, KRISHNA INSTITUTE OF MEDICAL SCIENCES "DEEMED TO BE UNIVERSITY", KARAD , KRISHNA INSTITUTE OF MEDICAL SCIENCES "DEEMED TO BE UNIVERSITY", NEAR DHEBEWADI ROAD, MALKAPUR, TAL – KARAD, DIST. – SATARA, MAHARASHTRA, INDIA-415539 INDIAN
3. Nature of the applicant's interest in the copyright of the work : OWNER
4. Class and description of the work : LITERARY/ DRAMATIC WORK
5. Title of the work : INTRA ORAL MASSAGER
6. Language of the work : ENGLISH
7. Name, address and nationality of the author and if the author is deceased, date of his decease : DR. SHUBHA JOSHI , ASSOC. PROFESSOR, SCHOOL OF DENTAL SCIENCES, KRISHNA INSTITUTE OF MEDICAL SCIENCES "DEEMED TO BE UNIVERSITY", NEAR DHEBEWADI ROAD, MALKAPUR, TAL – KARAD, DIST. – SATARA, MAHARASHTRA, INDIA,-415539 INDIAN
8. Whether the work is published or unpublished : UNPUBLISHED
9. Year and country of first publication and name, address and nationality of the publisher : N.A.
10. Years and countries of subsequent publications, if any, and names, addresses and nationalities of the publishers : N.A.
11. Names, addresses and nationalities of the owners of various rights comprising the copyright in the work and the extent of rights held by each, together with particulars of assignments and licences, if any : SCHOOL OF DENTAL SCIENCES, KRISHNA INSTITUTE OF MEDICAL SCIENCES "DEEMED TO BE UNIVERSITY", KARAD , KRISHNA INSTITUTE OF MEDICAL SCIENCES "DEEMED TO BE UNIVERSITY", NEAR DHEBEWADI ROAD, MALKAPUR, TAL – KARAD, DIST. – SATARA, MAHARASHTRA, INDIA-415539 INDIAN
12. Names, addresses and nationalities of other persons, if any, authorised to assign or licence of rights comprising the copyright : N.A.
13. If the work is an 'Artistic work', the location of the original work, including name, address and nationality of the person in possession of the work. (In the case of an architectural work, the year of completion of the work should also be shown). : N.A.
14. If the work is an 'Artistic work' which is used or capable of being used in relation to any goods or services, the application should include a certification from the Registrar of Trade Marks in terms of the provision to Sub-Section (i) of Section 45 of the Copyright Act, 1957. : N.A.
15. If the work is an 'Artistic work', whether it is registered under the Designs Act 2000 if yes give details. : N.A.
16. If the work is an 'Artistic work', capable of being registered as a design under the Designs Act 2000, whether it has been applied to an article though an industrial process and ,if yes ,the number of times it is reproduced. : N.A.
17. Remarks :



10703/2020-CO/L

03/08/2020

03/08/2020



DEPUTY REGISTRAR OF COPYRIGHTS



Dated : 23/09/2020

1. Registration Number : **L-94957/2020**
2. Name, address and nationality of the applicant : SCHOOL OF DENTAL SCIENCES, KRISHNA INSTITUTE OF MEDICAL SCIENCES "DEEMED TO BE UNIVERSITY", KARAD , KRISHNA INSTITUTE OF MEDICAL SCIENCES "DEEMED TO BE UNIVERSITY", NEAR DHEBEWADI ROAD, MALKAPUR, TAL – KARAD, DIST. – SATARA, MAHARASHTRA, INDIA-415539 INDIAN
3. Nature of the applicant's interest in the copyright of the work : OWNER
4. Class and description of the work : LITERARY/ DRAMATIC WORK
5. Title of the work : RUGAE DUPLICATION USING RUGAL STAMPS
6. Language of the work : ENGLISH
7. Name, address and nationality of the author and if the author is deceased, date of his decease : DR. SHUBHA JOSHI , ASSOC. PROFESSOR, SCHOOL OF DENTAL SCIENCES, KRISHNA INSTITUTE OF MEDICAL SCIENCES "DEEMED TO BE UNIVERSITY", NEAR DHEBEWADI ROAD, MALKAPUR, TAL – KARAD, DIST. – SATARA, MAHARASHTRA, INDIA-415539 INDIAN
8. Whether the work is published or unpublished : UNPUBLISHED
9. Year and country of first publication and name, address and nationality of the publisher : N.A.
10. Years and countries of subsequent publications, if any, and names, addresses and nationalities of the publishers : N.A.
11. Names, addresses and nationalities of the owners of various rights comprising the copyright in the work and the extent of rights held by each, together with particulars of assignments and licences, if any : SCHOOL OF DENTAL SCIENCES, KRISHNA INSTITUTE OF MEDICAL SCIENCES "DEEMED TO BE UNIVERSITY", KARAD , KRISHNA INSTITUTE OF MEDICAL SCIENCES "DEEMED TO BE UNIVERSITY", NEAR DHEBEWADI ROAD, MALKAPUR, TAL – KARAD, DIST. – SATARA, MAHARASHTRA, INDIA-415539 INDIAN
12. Names, addresses and nationalities of other persons, if any, authorised to assign or licence of rights comprising the copyright : N.A.
13. If the work is an 'Artistic work', the location of the original work, including name, address and nationality of the person in possession of the work. (In the case of an architectural work, the year of completion of the work should also be shown). : N.A.
14. If the work is an 'Artistic work' which is used or capable of being used in relation to any goods or services, the application should include a certification from the Registrar of Trade Marks in terms of the provision to Sub-Section (i) of Section 45 of the Copyright Act, 1957. : N.A.
15. If the work is an 'Artistic work', whether it is registered under the Designs Act 2000 if yes give details. : N.A.
16. If the work is an 'Artistic work', capable of being registered as a design under the Designs Act 2000, whether it has been applied to an article though an industrial process and ,if yes ,the number of times it is reproduced. : N.A.
17. Remarks :



10768/2020-CO/L

04/08/2020

04/08/2020



DEPUTY REGISTRAR OF COPYRIGHTS



Dated : 23/09/2020

1. Registration Number : **L-94959/2020**
2. Name, address and nationality of the applicant : SCHOOL OF DENTAL SCIENCES, KRISHNA INSTITUTE OF MEDICAL SCIENCES "DEEMED TO BE UNIVERSITY", KARAD , KRISHNA INSTITUTE OF MEDICAL SCIENCES DEEMED TO BE UNIVERSITY, KARAD, MALKAPUR, MAHARASHTRA, INDIA-415539 INDIAN
3. Nature of the applicant's interest in the copyright of the work : OWNER
4. Class and description of the work : LITERARY/ DRAMATIC WORK
5. Title of the work : ORAL HEALTH EDUCATION FOR ELDERLY PEOPLE USING MOBILE PHONE
6. Language of the work : ENGLISH
7. Name, address and nationality of the author and if the author is deceased, date of his decease : DR ASHWINI RANI SR , DEPARTMENT OF ORAL MEDICINE & RADIOLOGY SCHOOL OF DENTAL SCIENCES, KRISHNA INSTITUTE OF MEDICAL SCIENCES "DEEMED TO BE UNIVERSITY", KARAD-415539 INDIAN
DR GIRISH SURAGIMATH , DEPARTMENT OF ORAL MEDICINE & RADIOLOGY SCHOOL OF DENTAL SCIENCES, KRISHNA INSTITUTE OF MEDICAL SCIENCES "DEEMED TO BE UNIVERSITY", KARAD-415539 INDIAN
8. Whether the work is published or unpublished : UNPUBLISHED
9. Year and country of first publication and name, address and nationality of the publisher : N.A.
10. Years and countries of subsequent publications, if any, and names, addresses and nationalities of the publishers : N.A.
11. Names, addresses and nationalities of the owners of various rights comprising the copyright in the work and the extent of rights held by each, together with particulars of assignments and licences, if any : SCHOOL OF DENTAL SCIENCES, KRISHNA INSTITUTE OF MEDICAL SCIENCES "DEEMED TO BE UNIVERSITY", KARAD , KRISHNA INSTITUTE OF MEDICAL SCIENCES DEEMED TO BE UNIVERSITY, KARAD, MALKAPUR, MAHARASHTRA, INDIA-415539 INDIAN
12. Names, addresses and nationalities of other persons, if any, authorised to assign or licence of rights comprising the copyright : N.A.
13. If the work is an 'Artistic work', the location of the original work, including name, address and nationality of the person in possession of the work. (In the case of an architectural work, the year of completion of the work should also be shown). : N.A.
14. If the work is an 'Artistic work' which is used or capable of being used in relation to any goods or services, the application should include a certification from the Registrar of Trade Marks in terms of the provision to Sub-Section (i) of Section 45 of the Copyright Act, 1957. : N.A.
15. If the work is an 'Artistic work', whether it is registered under the Designs Act, 2000, if yes give details. : N.A.
16. If the work is an 'Artistic work', capable of being registered as a trademark under the Trademarks Act 2000, whether it has been applied to an application for registration, if yes, the number of times : N.A.
17. :



Di : 10642/2020-CO/L
Date of Application : 02/08/2020
Date of Receipt : 02/08/2020

DEPUTY REGISTRAR OF COPYRIGHTS



Dated : 15/09/2020

1. Registration Number : **L-94738/2020**
2. Name, address and nationality of the applicant : KRISHNA INSTITUTE OF MEDICAL SCIENCES "DEEMED TO BE UNIVERSITY", KARAD , KRISHNA INSTITUTE OF MEDICAL SCIENCES "DEEMED TO BE UNIVERSITY", KARAD , NEAR DHEBEWADI ROAD, MALKAPUR, TAL – KARAD, DIST. – SATARA, MAHARASHTRA, INDIA-415539 INDIAN
3. Nature of the applicant's interest in the copyright of the work : OWNER
4. Class and description of the work : LITERARY/ DRAMATIC WORK
5. Title of the work : DEMONSTRATION OF MECHANICAL INJURIES STAB, INCISION AND LACERATION ON A CLOTH MATERIAL
6. Language of the work : ENGLISH
7. Name, address and nationality of the author and if the author is deceased, date of his decease : DR. VINAY BANNUR , DEPARTMENT OF FORENSIC MEDICINE & TOXICOLOGY, KRISHNA INSTITUTE OF MEDICAL SCIENCES "DEEMED TO BE UNIVERSITY", KARAD , NEAR DHEBEWADI ROAD, MALKAPUR, TAL – KARAD, DIST. – SATARA, MAHARASHTRA, INDIA-415539 INDIAN
8. Whether the work is published or unpublished : UNPUBLISHED
9. Year and country of first publication and name, address and nationality of the publisher : N.A.
10. Years and countries of subsequent publications, if any, and names, addresses and nationalities of the publishers : N.A.
11. Names, addresses and nationalities of the owners of various rights comprising the copyright in the work and the extent of rights held by each, together with particulars of assignments and licences, if any : KRISHNA INSTITUTE OF MEDICAL SCIENCES "DEEMED TO BE UNIVERSITY", KARAD , KRISHNA INSTITUTE OF MEDICAL SCIENCES "DEEMED TO BE UNIVERSITY", KARAD , NEAR DHEBEWADI ROAD, MALKAPUR, TAL – KARAD, DIST. – SATARA, MAHARASHTRA, INDIA-415539 INDIAN
12. Names, addresses and nationalities of other persons, if any, authorised to assign or licence of rights comprising the copyright : N.A.
13. If the work is an 'Artistic work', the location of the original work, including name, address and nationality of the person in possession of the work. (In the case of an architectural work, the year of completion of the work should also be shown). : N.A.
14. If the work is an 'Artistic work' which is used or capable of being used in relation to any goods or services, the application should include a certification from the Registrar of Trade Marks in terms of the provision to Sub-Section (i) of Section 45 of the Copyright Act, 1957. : N.A.
15. If the work is an 'Artistic work', whether it is registered under the Designs Act 2000 if yes give details. : N.A.
16. If the work is an 'Artistic work', capable of being registered as a design under the Designs Act 2000.whether it has been applied to an article though an industrial process and ,if yes ,the number of times it is reproduced. : N.A.
17. Remarks, if any :



Dis : 10771/2020-CO/L
04/08/2020
04/08/2020



DEPUTY REGISTRAR OF COPYRIGHTS



Dated : 21/09/2020

1. Registration Number : **L-94897/2020**
2. Name, address and nationality of the applicant : KRISHNA INSTITUTE OF MEDICAL SCIENCES "DEEMED TO BE UNIVERSITY", KARAD , KRISHNA INSTITUTE OF MEDICAL SCIENCES "DEEMED TO BE UNIVERSITY", KARAD, NEAR DHEBEWADI ROAD, MALKAPUR, TAL – KARAD, DIST. – SATARA, MAHARASHTRA, INDIA,-415539 INDIAN
3. Nature of the applicant's interest in the copyright of the work : OWNER
4. Class and description of the work : LITERARY/ DRAMATIC WORK
5. Title of the work : STUDENT LEARNING BY PERFORMING UNDER FACULTY SUPERVISION DEMONSTRATION OF MECHANICAL INJURIES STAB, INCISION AND LACERATION ON CLOTH MATERIAL
6. Language of the work : ENGLISH
7. Name, address and nationality of the author and if the author is deceased, date of his decease : DR. VINAY BANNUR , DEPARTMENT OF FORENSIC MEDICINE & TOXICOLOGY, KRISHNA INSTITUTE OF MEDICAL SCIENCES "DEEMED TO BE UNIVERSITY", KARAD, NEAR DHEBEWADI ROAD, MALKAPUR, TAL – KARAD, DIST. – SATARA, MAHARASHTRA, INDIA,-415539 INDIAN
8. Whether the work is published or unpublished : UNPUBLISHED
9. Year and country of first publication and name, address and nationality of the publisher : N.A.
10. Years and countries of subsequent publications, if any, and names, addresses and nationalities of the publishers : N.A.
11. Names, addresses and nationalities of the owners of various rights comprising the copyright in the work and the extent of rights held by each, together with particulars of assignments and licences, if any : KRISHNA INSTITUTE OF MEDICAL SCIENCES "DEEMED TO BE UNIVERSITY", KARAD , KRISHNA INSTITUTE OF MEDICAL SCIENCES "DEEMED TO BE UNIVERSITY", KARAD, NEAR DHEBEWADI ROAD, MALKAPUR, TAL – KARAD, DIST. – SATARA, MAHARASHTRA, INDIA,-415539 INDIAN
12. Names, addresses and nationalities of other persons, if any, authorised to assign or licence of rights comprising the copyright : N.A.
13. If the work is an 'Artistic work', the location of the original work, including name, address and nationality of the person in possession of the work. (In the case of an architectural work, the year of completion of the work should also be shown). : N.A.
14. If the work is an 'Artistic work' which is used or capable of being used in relation to any goods or services, the application should include a certification from the Registrar of Trade Marks in terms of the provision to Sub-Section (i) of Section 45 of the Copyright Act, 1957. : N.A.
15. If the work is an 'Artistic work', whether it is registered under the Designs Act 2000 if yes give details. : N.A.
16. If the work is an 'Artistic work', capable of being registered as a design under the Designs Act 2000, whether it has been applied to an article though an industrial process and, if yes, the number of times it is reproduced. : N.A.
17. Re : :



10772/2020-CO/L

04/08/2020

04/08/2020



DEPUTY REGISTRAR OF COPYRIGHTS



Dated : 24/09/2020

1. Registration Number : **L-95043/2020**
2. Name, address and nationality of the applicant : KRISHNA INSTITUTE OF MEDICAL SCIENCES "DEEMED TO BE UNIVERSITY", KARAD , NH4, PUNE - BANGALORE HIGHWAY, DIST.SATARA, AGASHIVNAGAR, MALKAPUR, MAHARASHTRA-415539 INDIAN
3. Nature of the applicant's interest in the copyright of the work : OWNER
4. Class and description of the work : LITERARY/ DRAMATIC WORK
5. Title of the work : EXTRACTION SCHEME FOR ISOLATION OF PHENANTHRENE ALKALOIDS FROM EULOPHIA OCHREATA LINDL
6. Language of the work : ENGLISH
7. Name, address and nationality of the author and if the author is deceased, date of his decease : MRS. AKSHADA AMIT KOPARDE , DEPARTMENT OF PHARMACEUTICAL CHEMISTRY, KRISHNA INSTITUTE OF PHARMACY, KRISHNA INSTITUTE OF MEDICAL SCIENCES DEEMED TO BE UNIVERSITY NH4, PUNE - BANGALORE HIGHWAY, DIST.SATARA, AGASHIVNAGAR, MALKAPUR,- 415539 INDIAN
MR.ANUP PATIL , DEPARTMENT OF PHARMACEUTICAL CHEMISTRY, KRISHNA INSTITUTE OF PHARMACY, KRISHNA INSTITUTE OF MEDICAL SCIENCES DEEMED TO BE UNIVERSITY NH4, PUNE - BANGALORE HIGHWAY, DIST.SATARA, AGASHIVNAGAR, MALKAPUR,-415539 INDIAN
DR.R.C.DOIJAD , DEPARTMENT OF PHARMACEUTICAL CHEMISTRY, KRISHNA INSTITUTE OF PHARMACY, KRISHNA INSTITUTE OF MEDICAL SCIENCES DEEMED TO BE UNIVERSITY NH4, PUNE - BANGALORE HIGHWAY, DIST.SATARA, AGASHIVNAGAR, MALKAPUR,-415539 INDIAN
8. Whether the work is published or unpublished : UNPUBLISHED
9. Year and country of first publication and name, address and nationality of the publisher : N.A.
10. Years and countries of subsequent publications, if any, and names, addresses and nationalities of the publishers : N.A.
11. Names, addresses and nationalities of the owners of various rights comprising the copyright in the work and the extent of rights held by each, together with particulars of assignments and licences, if any : KRISHNA INSTITUTE OF MEDICAL SCIENCES "DEEMED TO BE UNIVERSITY", KARAD , NH4, PUNE - BANGALORE HIGHWAY, DIST.SATARA, AGASHIVNAGAR, MALKAPUR, MAHARASHTRA-415539 INDIAN
12. Names, addresses and nationalities of other persons, if any, authorised to assign or licence of rights comprising the copyright : KRISHNA INSTITUTE OF MEDICAL SCIENCES "DEEMED TO BE UNIVERSITY", KARAD , NH4, PUNE - BANGALORE HIGHWAY, DIST.SATARA, AGASHIVNAGAR, MALKAPUR, MAHARASHTRA-415539 INDIAN
13. If the work is an 'Artistic work', the location of the original work, including the address and nationality of the person in possession of the work, and in the case of an architectural work, the year of construction (if any) should also be shown). : N.A.
14. If the work is a 'work' which is used or capable of being used in goods or services, the application should be filed with the Registrar of Trade Marks in terms of Section (i) of Section 45 of the Copyright Act, : N.A.
15. If the work is an 'Artistic work', whether it is registered under the Designs Act 2000 if yes give details. : N.A.
16. If the work is an 'Artistic work', capable of being registered as a design under the Designs Act 2000.whether it has been applied to an article though an industrial process and ,if yes ,the number of times it is reproduced. : N.A.
17. Remarks, if any :





DEPUTY REGISTRAR OF COPYRIGHTS

Diary Number : 11358/2020-CO/L
Date of Application : 14/08/2020
Date of Receipt : 14/08/2020



A handwritten signature in blue ink, written in a cursive style, is positioned above the official title.

DEPUTY REGISTRAR OF COPYRIGHTS



Dated : 24/09/2020

1. Registration Number : **L-95044/2020**
2. Name, address and nationality of the applicant : KRISHNA INSTITUTE OF MEDICAL SCIENCES "DEEMED TO BE UNIVERSITY", KARAD , NH4, PUNE - BANGALORE HIGHWAY, DIST.SATARA, AGASHIVNAGAR, MALKAPUR, MAHARASHTRA-415539 INDIAN
3. Nature of the applicant's interest in the copyright of the work : OWNER
4. Class and description of the work : LITERARY/ DRAMATIC WORK
5. Title of the work : QUESTIONNAIRE ON VIEWS OF STUDENTS ON THEIR CHOSEN PHARMACY AS A PROFESSIONAL CAREER
6. Language of the work : ENGLISH
7. Name, address and nationality of the author and if the author is deceased, date of his decease : MRS. AKSHADA AMIT KOPARDE , DEPARTMENT OF PHARMACEUTICAL CHEMISTRY, KRISHNA INSTITUTE OF PHARMACY, KRISHNA INSTITUTE OF MEDICAL SCIENCES DEEMED TO BE UNIVERSITY NH4, PUNE - BANGALORE HIGHWAY, DIST.SATARA, AGASHIVNAGAR, MALKAPUR,- 415539 INDIAN
DR.R.C.DOIJAD , DEPARTMENT OF PHARMACEUTICAL CHEMISTRY, KRISHNA INSTITUTE OF PHARMACY, KRISHNA INSTITUTE OF MEDICAL SCIENCES DEEMED TO BE UNIVERSITY NH4, PUNE - BANGALORE HIGHWAY, DIST.SATARA, AGASHIVNAGAR, MALKAPUR,-415539 INDIAN
MR.ANUP PATIL , DEPARTMENT OF PHARMACEUTICAL CHEMISTRY, KRISHNA INSTITUTE OF PHARMACY, KRISHNA INSTITUTE OF MEDICAL SCIENCES DEEMED TO BE UNIVERSITY NH4, PUNE - BANGALORE HIGHWAY, DIST.SATARA, AGASHIVNAGAR, MALKAPUR,-415539 INDIAN
8. Whether the work is published or unpublished : UNPUBLISHED
9. Year and country of first publication and name, address and nationality of the publisher : N.A.
10. Years and countries of subsequent publications, if any, and names, addresses and nationalities of the publishers : N.A.
11. Names, addresses and nationalities of the owners of various rights comprising the copyright in the work and the extent of rights held by each, together with particulars of assignments and licences, if any : KRISHNA INSTITUTE OF MEDICAL SCIENCES "DEEMED TO BE UNIVERSITY", KARAD , NH4, PUNE - BANGALORE HIGHWAY, DIST.SATARA, AGASHIVNAGAR, MALKAPUR, MAHARASHTRA-415539 INDIAN
12. Names, addresses and nationalities of other persons, if any, authorised to assign or licence of rights comprising the copyright : KRISHNA INSTITUTE OF MEDICAL SCIENCES "DEEMED TO BE UNIVERSITY", KARAD , NH4, PUNE - BANGALORE HIGHWAY, DIST.SATARA, AGASHIVNAGAR, MALKAPUR, MAHARASHTRA-415539 INDIAN
13. If the work is an 'Artistic work', the location of the original work, including the address and nationality of the person in possession of the work (in the case of an architectural work, the year of construction of the work should also be shown). : N.A.
14. If the work is a 'work' which is used or capable of being used in goods or services, the application should be filed with the Registrar of Trade Marks in terms of section (i) of Section 45 of the Copyright Act, : N.A.
15. If the work is an 'Artistic work', whether it is registered under the Designs Act 2000 if yes give details. : N.A.
16. If the work is an 'Artistic work', capable of being registered as a design under the Designs Act 2000, whether it has been applied to an article though an industrial process and ,if yes ,the number of times it is reproduced. : N.A.
17. Remarks, if any :



[Handwritten Signature]

DEPUTY REGISTRAR OF COPYRIGHTS

Diary Number : 11351/2020-CO/L
Date of Application : 14/08/2020
Date of Receipt : 14/08/2020



A handwritten signature in blue ink, written in a cursive style, is positioned above the official title.

DEPUTY REGISTRAR OF COPYRIGHTS



Dated : 24/09/2020

1. Registration Number : **L-95042/2020**
2. Name, address and nationality of the applicant : KRISHNA INSTITUTE OF MEDICAL SCIENCES "DEEMED TO BE UNIVERSITY", KARAD , NH4, PUNE - BANGALORE HIGHWAY, DIST.SATARA, AGASHIVNAGAR, MALKAPUR, MAHARASHTRA-415539 INDIAN
3. Nature of the applicant's interest in the copyright of the work : OWNER
4. Class and description of the work : LITERARY/ DRAMATIC WORK
5. Title of the work : HOMEOPATHIC MEDICINES FOR TREATMENT FOR SKIN DISEASES
6. Language of the work : ENGLISH
7. Name, address and nationality of the author and if the author is deceased, date of his decease : MR.ANUP ASHOK PATIL , DEPARTMENT OF PHARMACOLOGY KRISHNA INSTITUTE OF PHARMACY NH4, PUNE - BANGALORE HIGHWAY, DIST.SATARA, AGASHIVNAGAR, MALKAPUR, MAHARASHTRA-415539 INDIAN
DR.R.C.DOIJAD , DEPARTMENT OF PHARMACOLOGY KRISHNA INSTITUTE OF PHARMACY NH4, PUNE - BANGALORE HIGHWAY, DIST.SATARA, AGASHIVNAGAR, MALKAPUR, MAHARASHTRA-415539 INDIAN
MRS.A.A.KOPARDE , DEPARTMENT OF PHARMACOLOGY KRISHNA INSTITUTE OF PHARMACY NH4, PUNE - BANGALORE HIGHWAY, DIST.SATARA, AGASHIVNAGAR, MALKAPUR, MAHARASHTRA-415539 INDIAN
8. Whether the work is published or unpublished : UNPUBLISHED
9. Year and country of first publication and name, address and nationality of the publisher : N.A.
10. Years and countries of subsequent publications, if any, and names, addresses and nationalities of the publishers : N.A.
11. Names, addresses and nationalities of the owners of various rights comprising the copyright in the work and the extent of rights held by each, together with particulars of assignments and licences, if any : KRISHNA INSTITUTE OF MEDICAL SCIENCES "DEEMED TO BE UNIVERSITY", KARAD , NH4, PUNE - BANGALORE HIGHWAY, DIST.SATARA, AGASHIVNAGAR, MALKAPUR, MAHARASHTRA-415539 INDIAN
12. Names, addresses and nationalities of other persons, if any, authorised to assign or licence of rights comprising the copyright : KRISHNA INSTITUTE OF MEDICAL SCIENCES "DEEMED TO BE UNIVERSITY", KARAD , NH4, PUNE - BANGALORE HIGHWAY, DIST.SATARA, AGASHIVNAGAR, MALKAPUR, MAHARASHTRA-415539 INDIAN
13. If the work is an 'Artistic work', the location of the original work, including name, address and nationality of the person in possession of the work. (In the case of an architectural work, the year of completion of the work should also be shown). : N.A.
14. If the work is an 'Artistic work' which is used or capable of being used in connection with goods or services, the application should be filed with the Registrar of Trade Marks in terms of Section (i) of Section 45 of the Copyright Act, 1957. : N.A.
15. If the work is an 'Artistic work', whether it is registered under the Designs Act, 2000, give details. : N.A.
16. If the work is an 'Artistic work', capable of being registered as a design under the Designs Act 2000, whether it has been applied to an article though an industrial process and ,if yes ,the number of times it is reproduced. : N.A.
17. Remarks, if any : N.A.





DEPUTY REGISTRAR OF COPYRIGHTS



A handwritten signature in black ink, written in a cursive style, is positioned above the printed name of the Deputy Registrar of Copyrights.

DEPUTY REGISTRAR OF COPYRIGHTS



Dated : 24/09/2020

1. Registration Number : **L-95041/2020**
 2. Name, address and nationality of the applicant : KRISHNA INSTITUTE OF MEDICAL SCIENCES "DEEMED TO BE UNIVERSITY", KARAD , NH4, PUNE - BANGALORE HIGHWAY, DIST.SATARA, AGASHIVNAGAR, MALKAPUR, MAHARASHTRA-415539 INDIAN
 3. Nature of the applicant's interest in the copyright of the work : OWNER
 4. Class and description of the work : LITERARY/ DRAMATIC WORK
 5. Title of the work : BEEWARE! - PHYSIOTHERAPIST'S CHECKLIST FOR TREATING A COVID 19 PATIENT
 6. Language of the work : ENGLISH
 7. Name, address and nationality of the author and if the author is deceased, date of his decease : DR.PRASANNAJEET PRAMOD NIKAM , FACULTY OF PHYSIOTHERAPY, KRISHNA INSTITUTE OF MEDICAL SCIENCES DEEMED TO BE UNIVERSITY, NH4, PUNE - BANGALORE HIGHWAY, DIST.SATARA, AGASHIVNAGAR, MALKAPUR, MAHARASHTRA-415539 INDIAN
DR.GOVINDHAN VARADHARAJULU , FACULTY OF PHYSIOTHERAPY, KRISHNA INSTITUTE OF MEDICAL SCIENCES DEEMED TO BE UNIVERSITY, NH4, PUNE - BANGALORE HIGHWAY, DIST.SATARA, AGASHIVNAGAR, MALKAPUR, MAHARASHTRA-415539 INDIAN
 8. Whether the work is published or unpublished : UNPUBLISHED
 9. Year and country of first publication and name, address and nationality of the publisher : N.A.
 10. Years and countries of subsequent publications, if any, and names, addresses and nationalities of the publishers : N.A.
 11. Names, addresses and nationalities of the owners of various rights comprising the copyright in the work and the extent of rights held by each, together with particulars of assignments and licences, if any : KRISHNA INSTITUTE OF MEDICAL SCIENCES "DEEMED TO BE UNIVERSITY", KARAD , NH4, PUNE - BANGALORE HIGHWAY, DIST.SATARA, AGASHIVNAGAR, MALKAPUR, MAHARASHTRA-415539 INDIAN
 12. Names, addresses and nationalities of other persons, if any, authorised to assign or licence of rights comprising the copyright : KRISHNA INSTITUTE OF MEDICAL SCIENCES "DEEMED TO BE UNIVERSITY", KARAD , NH4, PUNE - BANGALORE HIGHWAY, DIST.SATARA, AGASHIVNAGAR, MALKAPUR, MAHARASHTRA-415539 INDIAN
 13. If the work is an 'Artistic work', the location of the original work, including name, address and nationality of the person in possession of the work. (In the case of an architectural work, the year of completion of the work should also be shown). : N.A.
 14. If the work is an 'Artistic work' which is used or capable of being used in relation to any goods or services, the application should include a certification from the Registrar of Trade Marks in terms of the provision to Sub-Section (i) of Section 45 of the Copyright Act, 1957. : N.A.
 15. If the work is an 'Artistic work', whether it is registered under the : N.A.
 16. If the work is an 'Artistic work', capable of being registered as a : N.A.
 17. Registrar : 
DEPUTY REGISTRAR OF COPYRIGHTS
- Diary Number : 11362/2020-CO/L
Date of Application : 14/08/2020
Date of Receipt : 14/08/2020





Dated : 24/09/2020

1. Registration Number : **L-95040/2020**
2. Name, address and nationality of the applicant : KRISHNA INSTITUTE OF MEDICAL SCIENCES "DEEMED TO BE UNIVERSITY", KARAD , NH4, PUNE - BANGALORE HIGHWAY, DIST.SATARA, AGASHIVNAGAR, MALKAPUR, MAHARASHTRA-415539 INDIAN
3. Nature of the applicant's interest in the copyright of the work : OWNER
4. Class and description of the work : LITERARY/ DRAMATIC WORK
5. Title of the work : ONLINE SEMINAR-ON HOW TO USE PROFORMA FOR AGE DETERMINATION PRACTICAL WITH HELP OF AUDIO-VIDEO PRESENTATION USING LAPTOP & MOBILE
6. Language of the work : ENGLISH
7. Name, address and nationality of the author and if the author is deceased, date of his decease : DR AJAY VINAYAK PATIL , DEPARTMENT OF FORENSIC MEDICINE & TOXICOLOGY, KRISHNA INSTITUTE OF MEDICAL SCIENCES "DEEMED TO BE UNIVERSITY, KARAD , NH4, PUNE - BANGALORE HIGHWAY, DIST.SATARA, AGASHIVNAGAR, MALKAPUR, MAHARASHTRA-415539 INDIAN

DR CHANDRAKANT M. KOKATANUR , DEPARTMENT OF FORENSIC MEDICINE & TOXICOLOGY, KRISHNA INSTITUTE OF MEDICAL SCIENCES "DEEMED TO BE UNIVERSITY, KARAD , NH4, PUNE - BANGALORE HIGHWAY, DIST.SATARA, AGASHIVNAGAR, MALKAPUR, MAHARASHTRA-415539 INDIAN

DR VINAY BANNUR , DEPARTMENT OF FORENSIC MEDICINE & TOXICOLOGY, KRISHNA INSTITUTE OF MEDICAL SCIENCES "DEEMED TO BE UNIVERSITY, KARAD , NH4, PUNE - BANGALORE HIGHWAY, DIST.SATARA, AGASHIVNAGAR, MALKAPUR, MAHARASHTRA-415539 INDIAN

MS. YOSHI CHAWLA , DEPARTMENT OF FORENSIC MEDICINE & TOXICOLOGY, KRISHNA INSTITUTE OF MEDICAL SCIENCES "DEEMED TO BE UNIVERSITY, KARAD , NH4, PUNE - BANGALORE HIGHWAY, DIST.SATARA, AGASHIVNAGAR, MALKAPUR, MAHARASHTRA-415539 INDIAN
8. Whether the work is published or unpublished : UNPUBLISHED
9. Year and country of first publication and name, address and nationality of the publisher : N.A.
10. Years and countries of subsequent publications, if any, and names, addresses and nationalities of the publishers : N.A.
11. Names, addresses and nationalities of the owners of various rights comprising the copyright in the work and the extent of rights held by each, together with particulars of assignments and licences, if any : KRISHNA INSTITUTE OF MEDICAL SCIENCES "DEEMED TO BE UNIVERSITY", KARAD , NH4, PUNE - BANGALORE HIGHWAY, DIST.SATARA, AGASHIVNAGAR, MALKAPUR, MAHARASHTRA-415539 INDIAN
12. Names, addresses and nationalities of other persons, if any, and the extent of rights comprising the copyright : KRISHNA INSTITUTE OF MEDICAL SCIENCES "DEEMED TO BE UNIVERSITY", KARAD , NH4, PUNE - BANGALORE HIGHWAY, DIST.SATARA, AGASHIVNAGAR, MALKAPUR, MAHARASHTRA-415539 INDIAN
13. If the work is an 'Artistic work', the location of the original work, including the name, address and nationality of the person in possession of the work. (In the case of an architectural work, the year of completion of the work should also be shown). : N.A. **DEPUTY REGISTRAR OF COPYRIGHTS**
14. If the work is an 'Artistic work' which is used or capable of being used in relation to any goods or services, the application should include a certification from the Registrar of Trade Marks in terms of the provision to Sub-Section (i) of Section 45 of the Copyright Act, 1957. : N.A.



15. If the work is an 'Artistic work', whether it is registered under the Designs Act 2000 if yes give details. : N.A.
16. If the work is an 'Artistic work', capable of being registered as a design under the Designs Act 2000.whether it has been applied to an article though an industrial process and ,if yes ,the number of times it is reproduced. : N.A.
17. Remarks, if any :
- Diary Number : 11365/2020-CO/L
- Date of Application : 14/08/2020
- Date of Receipt : 14/08/2020



A handwritten signature in blue ink, written in a cursive style, is positioned above the title of the official.

DEPUTY REGISTRAR OF COPYRIGHTS



Dated : 25/09/2020

1. Registration Number : **L-95074/2020**
2. Name, address and nationality of the applicant : KRISHNA INSTITUTE OF MEDICAL SCIENCES "DEEMED TO BE UNIVERSITY", KARAD , KRISHNA INSTITUTE OF MEDICAL SCIENCES DEEMED TO BE UNIVERSITY, NEAR DHEBEWADI ROAD, MALKAPUR TAL – KARAD. DIST. – SATARA, MAHARASHTRA, INDIA-415539
INDIAN
3. Nature of the applicant's interest in the copyright of the work : OWNER
4. Class and description of the work : LITERARY/ DRAMATIC WORK
5. Title of the work : PREVENTIVE CARDIOLOGY CLINIC
6. Language of the work : ENGLISH
7. Name, address and nationality of the author and if the author is deceased, date of his decease : DR. UDDHAV KUMBHAR , DEPARTMENT OF COMMUNITY MEDICINE
KRISHNA INSTITUTE OF MEDICAL SCIENCES,
KRISHNA INSTITUTE OF MEDICAL SCIENCES "DEEMED TO BE UNIVERSITY", KARAD, DIST. – SATARA,
MAHARASHTRA, INDIA,-415539
INDIAN
8. Whether the work is published or unpublished : UNPUBLISHED
9. Year and country of first publication and name, address and nationality of the publisher : N.A.
10. Years and countries of subsequent publications, if any, and names, addresses and nationalities of the publishers : N.A.
11. Names, addresses and nationalities of the owners of various rights comprising the copyright in the work and the extent of rights held by each, together with particulars of assignments and licences, if any : KRISHNA INSTITUTE OF MEDICAL SCIENCES "DEEMED TO BE UNIVERSITY", KARAD , KRISHNA INSTITUTE OF MEDICAL SCIENCES DEEMED TO BE UNIVERSITY, NEAR DHEBEWADI ROAD, MALKAPUR TAL – KARAD. DIST. – SATARA, MAHARASHTRA, INDIA-415539
INDIAN
12. Names, addresses and nationalities of other persons, if any, authorised to assign or licence of rights comprising the copyright : N.A.
13. If the work is an 'Artistic work', the location of the original work, including name, address and nationality of the person in possession of the work. (In the case of an architectural work, the year of completion of the work should also be shown). : N.A.
14. If the work is an 'Artistic work' which is used or capable of being used in relation to any goods or services, the application should include a certification from the Registrar of Trade Marks in terms of the provision to Sub-Section (i) of Section 45 of the Copyright Act, 1957. : N.A.
15. If the work is an 'Artistic work', whether it is registered under the Designs Act 2000 if yes give details. : N.A.
16. If the work is an 'Artistic work', capable of being registered as a design under the Designs Act 2000. whether it has been applied to an article though an industrial process and ,if yes ,the number of times it is reproduced. : N.A.
17. Remarks, if any :



Dis : 11545/2020-CO/L
18/08/2020
18/08/2020



DEPUTY REGISTRAR OF COPYRIGHTS



Dated : 23/09/2020

1. Registration Number : **L-94950/2020**
2. Name, address and nationality of the applicant : KRISHNA INSTITUTE OF MEDICAL SCIENCES DEEMED TO BE UNIVERSITY, KARAD, MAHARASHTRA. , KRISHNA INSTITUTE OF MEDICAL SCIENCES "DEEMED TO BE UNIVERSITY" NEAR DHEBEWADI ROAD, MALKAPUR, TAL-KARAD, DIST: SATARA, MAHARASHTRA, INDIA-415539 INDIAN
3. Nature of the applicant's interest in the copyright of the work : OWNER
4. Class and description of the work : LITERARY/ DRAMATIC WORK
5. Title of the work : VIDEO ASSISTED BREATHING TECHNIQUE COVID 19
6. Language of the work : ENGLISH
7. Name, address and nationality of the author and if the author is deceased, date of his decease : DR.CHANDRAKANT PATIL , ASSISTANT PROFESSOR, KRISHNA COLLEGE OF PHYSIOTHERAPY; KRISHNA INSTITUTE OF MEDICAL SCIENCES, DEEMED TO BE UNIVERSITY KARAD, MAHARASHTRA-415539 INDIAN
DR.SMITA PATIL , ASSISTANT PROFESSOR, KRISHNA COLLEGE OF PHYSIOTHERAPY; KRISHNA INSTITUTE OF MEDICAL SCIENCES, DEEMED TO BE UNIVERSITY KARAD, MAHARASHTRA-415539 INDIAN
8. Whether the work is published or unpublished : UNPUBLISHED
9. Year and country of first publication and name, address and nationality of the publisher : N.A.
10. Years and countries of subsequent publications, if any, and names, addresses and nationalities of the publishers : N.A.
11. Names, addresses and nationalities of the owners of various rights comprising the copyright in the work and the extent of rights held by each, together with particulars of assignments and licences, if any : KRISHNA INSTITUTE OF MEDICAL SCIENCES DEEMED TO BE UNIVERSITY, KARAD, MAHARASHTRA. , KRISHNA INSTITUTE OF MEDICAL SCIENCES "DEEMED TO BE UNIVERSITY" NEAR DHEBEWADI ROAD, MALKAPUR, TAL-KARAD, DIST: SATARA, MAHARASHTRA, INDIA-415539 INDIAN
12. Names, addresses and nationalities of other persons, if any, authorised to assign or licence of rights comprising the copyright : N.A.
13. If the work is an 'Artistic work', the location of the original work, including name, address and nationality of the person in possession of the work. (In the case of an architectural work, the year of completion of the work should also be shown). : N.A.
14. If the work is an 'Artistic work' which is used or capable of being used in relation to any goods or services, the application should include a certification from the Registrar of Trade Marks in terms of the provision to Sub-Section (i) of Section 45 of the Copyright Act, 1957. : N.A.
15. If the work is an 'Artistic work', whether it is registered under the Designs Act 2000 if yes give details. : N.A.
16. If the work is an 'Artistic work', capable of being registered as a design under the Designs Act 2000, whether it has been applied to an article, if yes, the number of times : N.A.

17. :
11600/2020-CO/L
19/08/2020
Date of registration : 19/08/2020





DEPUTY REGISTRAR OF COPYRIGHTS



Dated : 23/09/2020

1. Registration Number : **L-94951/2020**
2. Name, address and nationality of the applicant : KRISHNA INSTITUTE OF MEDICAL SCIENCES DEEMED TO BE UNIVERSITY, KARAD, MAHARASHTRA , KRISHNA INSTITUTE OF MEDICAL SCIENCES "DEEMED TO BE UNIVERSITY" NEAR DHEBEWADI ROAD, MALKAPUR, TAL-KARAD, DIST: SATARA, MAHARASHTRA, INDIA-415539 INDIAN
3. Nature of the applicant's interest in the copyright of the work : OWNER
4. Class and description of the work : LITERARY/ DRAMATIC WORK
5. Title of the work : TEACHING METHODOLOGY USING YOU TUBE VIDEOS
6. Language of the work : ENGLISH
7. Name, address and nationality of the author and if the author is deceased, date of his decease : DR GIRISH SURAGIMATH , DEPARTMENT OF PERIODONTOLOGY, SCHOOL OF DENTAL SCIENCES, KRISHNA INSTITUTE OF MEDICAL SCIENCES "DEEMED TO BE UNIVERSITY", KARAD-415539 INDIAN
DR SIDDHARTH VARMA , DEPARTMENT OF PERIODONTOLOGY, SCHOOL OF DENTAL SCIENCES, KRISHNA INSTITUTE OF MEDICAL SCIENCES "DEEMED TO BE UNIVERSITY", KARAD-415539 INDIAN
DR SAMEER ZOPE , DEPARTMENT OF PERIODONTOLOGY, SCHOOL OF DENTAL SCIENCES, KRISHNA INSTITUTE OF MEDICAL SCIENCES "DEEMED TO BE UNIVERSITY", KARAD-415539 INDIAN
DR ASHWINI RANI SR , DEPARTMENT OF PERIODONTOLOGY, SCHOOL OF DENTAL SCIENCES, KRISHNA INSTITUTE OF MEDICAL SCIENCES "DEEMED TO BE UNIVERSITY", KARAD-415539 INDIAN
8. Whether the work is published or unpublished : UNPUBLISHED
9. Year and country of first publication and name, address and nationality of the publisher : N.A.
10. Years and countries of subsequent publications, if any, and names, addresses and nationalities of the publishers : N.A.
11. Names, addresses and nationalities of the owners of various rights comprising the copyright in the work and the extent of rights held by each, together with particulars of assignments and licences, if any : KRISHNA INSTITUTE OF MEDICAL SCIENCES DEEMED TO BE UNIVERSITY, KARAD, MAHARASHTRA , KRISHNA INSTITUTE OF MEDICAL SCIENCES "DEEMED TO BE UNIVERSITY" NEAR DHEBEWADI ROAD, MALKAPUR, TAL-KARAD, DIST: SATARA, MAHARASHTRA, INDIA-415539 INDIAN
12. Names, addresses and nationalities of other persons, if any, authorised to assign or licence of rights comprising the copyright : N.A.
13. If the work is an 'Artistic work', the location of the original work, including name, address and nationality of the person in possession of the work. In the case of an architectural work, the year of completion of the work should also be shown). : N.A.
14. If the work is an 'Artistic work' which is used or capable of being used in connection with goods or services, the application should be made to the Registrar of Trade Marks in terms of Section (i) of Section 45 of the Copyright Act, : N.A.
15. If the work is an 'Artistic work', whether it is registered under the Designs Act 2000, if yes give details. : N.A.
16. If the work is an 'Artistic work', capable of being registered as a design under the Designs Act 2000, whether it has been applied to an article though an industrial process and, if yes, the number of times it is reproduced. : N.A.
17. Remarks, if any :





DEPUTY REGISTRAR OF COPYRIGHTS

Date of Application : 19/08/2020
Date of Receipt : 19/08/2020



A handwritten signature in blue ink, written in a cursive style, is positioned above the official title.

DEPUTY REGISTRAR OF COPYRIGHTS



Dated : 23/09/2020

1. Registration Number : **L-94949/2020**
2. Name, address and nationality of the applicant : KRISHNA INSTITUTE OF MEDICAL SCIENCES "DEEMED TO BE UNIVERSITY", KARAD , KRISHNA INSTITUTE OF MEDICAL SCIENCES "DEEMED TO BE UNIVERSITY" NEAR DHEBEWADI ROAD, MALKAPUR, TAL-KARAD, DIST: SATARA, MAHARASHTRA, INDIA-415539
INDIAN
3. Nature of the applicant's interest in the copyright of the work : OWNER
4. Class and description of the work : LITERARY/ DRAMATIC WORK
5. Title of the work : PANORAMIC TERERADIOLOGY: A TOOL TO TEACH TO DENTAL INTERNS ABOUT PANORAMIC
6. Language of the work : ENGLISH
7. Name, address and nationality of the author and if the author is deceased, date of his decease : DR ASHWINI RANI SR , SCHOOL OF DENTAL SCIENCES,KRISHNA INSTITUTE OF MEDICAL SCIENCES DEEMED TO BE UNIVERSITY, KARAD-415539
INDIAN

DR GIRISH SURAGIMATH , SCHOOL OF DENTAL SCIENCES,KRISHNA INSTITUTE OF MEDICAL SCIENCES DEEMED TO BE UNIVERSITY, KARAD-415539
INDIAN

DR SHASHI KIRAN ND , SCHOOL OF DENTAL SCIENCES,KRISHNA INSTITUTE OF MEDICAL SCIENCES DEEMED TO BE UNIVERSITY, KARAD-415539
INDIAN
8. Whether the work is published or unpublished : UNPUBLISHED
9. Year and country of first publication and name, address and nationality of the publisher : N.A.
10. Years and countries of subsequent publications, if any, and names, addresses and nationalities of the publishers : N.A.
11. Names, addresses and nationalities of the owners of various rights comprising the copyright in the work and the extent of rights held by each, together with particulars of assignments and licences, if any : KRISHNA INSTITUTE OF MEDICAL SCIENCES "DEEMED TO BE UNIVERSITY", KARAD , KRISHNA INSTITUTE OF MEDICAL SCIENCES "DEEMED TO BE UNIVERSITY" NEAR DHEBEWADI ROAD, MALKAPUR, TAL-KARAD, DIST: SATARA, MAHARASHTRA, INDIA-415539
INDIAN
12. Names, addresses and nationalities of other persons, if any, authorised to assign or licence of rights comprising the copyright : N.A.
13. If the work is an 'Artistic work', the location of the original work, including name, address and nationality of the person in possession of the work. (In the case of an architectural work, the year of completion of the work should also be shown). : N.A.
14. If the work is an 'Artistic work' which is used or capable of being used in relation to any goods or services, the application should include a certification from the Registrar of Trade Marks in terms of the provision to Sub-Section (i) of Section 45 of the Copyright Act, 1957. : N.A.
15. If the work is an 'Artistic work', whether it is registered under the Designs Act 2000 if yes give details. : N.A.
16. If the work is an 'Artistic work', capable of being registered as a design under the Designs Act 2000, whether it has been applied to an article, the date of application, the date of registration, the date of publication and, if yes, the number of times : N.A.
17. :



11594/2020-CO/L
Date of Application : 19/08/2020
Date of Receipt : 19/08/2020



DEPUTY REGISTRAR OF COPYRIGHTS



Dated : 29/09/2020

1. Registration Number : **L-95175/2020**
2. Name, address and nationality of the applicant :
DR VEDPRAKASH MISHRA , PRO CHANCELLOR, DATTA MEGHE INSTITUTE OF MEDICAL SCIENCE DEEMED TO BE UNIVERSITY, SAWANGI MEGHE, WARDHA-442107
INDIAN
DR LALITBHUSHAN WAGHMARE , PRO VICE CHANCELLOR, DATTA MEGHE INSTITUTE OF MEDICAL SCIENCE DEEMED TO BE UNIVERSITY, SAWANGI MEGHE, WARDHA-442107
INDIAN
DR RAJIV BORLE , VICE CHANCELLOR, DATTA MEGHE INSTITUTE OF MEDICAL SCIENCE DEEMED TO BE UNIVERSITY, SAWANGI MEGHE, WARDHA-442107
INDIAN
DR S P THYAGRAJAN , PROF OF EMINENCE, DEAN RESEARCH, SRI RAMACHANDRA INSTITUTE OF HIGHER EDUCATION AND RESEARCH DEEMED TO BE UNIVERSITY, CHENNAI-600116
INDIAN
DR DILIP MHAISEKAR , VICE CHANCELLOR, MAHARASHTRA UNIVERSITY OF HEALTH SCIENCES, NASHIK-422004
INDIAN
DR MOHANAN KUNNUMMAL , VICE CHANCELLOR, KERALA UNIVERSITY OF HEALTH SCIENCES, THRISSUR, KERALA-680596
INDIAN
DR O P KALRA , PT. BHAGWAT DAYAL SHARMA UNIVERSITY OF HEALTH SCIENCES, ROHTAK-124001
INDIAN
DR NEELAM MISHRA , VICE CHANCELLOR, KRISHNA INSTITUTE OF MEDICAL SCIENCES DEEMED TO BE UNIVERSITY, KARAD, MAHARASHTRA, INDIA-415539
INDIAN
3. Nature of the applicant's interest in the copyright of the work : AUTHOR
4. Class and description of the work : LITERARY/ DRAMATIC WORK
5. Title of the work : SEVEN PRONGED BLENDED LEARNING MODEL FOR INDIAN MEDICAL GRADUATE
6. Language of the work : ENGLISH





DEPUTY REGISTRAR OF COPYRIGHTS

7. Name, address and nationality of the author and if the author is deceased, date of his decease : DR VEDPRAKASH MISHRA , PRO CHANCELLOR, DATTA MEGHE INSTITUTE OF MEDICAL SCIENCE DEEMED TO BE UNIVERSITY, SAWANGI MEGHE, WARDHA-442107 INDIAN
DR LALITBHUSHAN WAGHMARE , PRO VICE CHANCELLOR, DATTA MEGHE INSTITUTE OF MEDICAL SCIENCE DEEMED TO BE UNIVERSITY, SAWANGI MEGHE, WARDHA-442107 INDIAN
DR RAJIV BORLE , VICE CHANCELLOR, DATTA MEGHE INSTITUTE OF MEDICAL SCIENCE DEEMED TO BE UNIVERSITY, SAWANGI MEGHE, WARDHA-442107 INDIAN
DR S P THYAGRAJAN , PROF OF EMINENCE, DEAN RESEARCH, SRI RAMACHANDRA INSTITUTE OF HIGHER EDUCATION AND RESEARCH DEEMED TO BE UNIVERSITY, CHENNAI-600116 INDIAN
DR DILIP MHAISEKAR , VICE CHANCELLOR, MAHARASHTRA UNIVERSITY OF HEALTH SCIENCES, NASHIK-422004 INDIAN
DR MOHANAN KUNNUMMAL , VICE CHANCELLOR, KERALA UNIVERSITY OF HEALTH SCIENCES, THRISSUR, KERALA-680596 INDIAN
DR O P KALRA , PT. BHAGWAT DAYAL SHARMA UNIVERSITY OF HEALTH SCIENCES, ROHTAK-124001 INDIAN
DR NEELAM MISHRA , VICE CHANCELLOR, KRISHNA INSTITUTE OF MEDICAL SCIENCES DEEMED TO BE UNIVERSITY, KARAD, MAHARASHTRA, INDIA-415539 INDIAN
8. Whether the work is published or unpublished : UNPUBLISHED
9. Year and country of first publication and name, address and nationality of the publisher : N.A.
10. Years and countries of subsequent publications, if any, and names, addresses and nationalities of the publishers : N.A.
11. Names, addresses and nationalities of the owners of various rights comprising the copyright in the work and the extent of rights held by each, together with particulars of assignments and licences, if any : DR VEDPRAKASH MISHRA , PRO CHANCELLOR, DATTA MEGHE INSTITUTE OF MEDICAL SCIENCE DEEMED TO BE UNIVERSITY, SAWANGI MEGHE, WARDHA-442107 INDIAN
DR LALITBHUSHAN WAGHMARE , PRO VICE CHANCELLOR, DATTA MEGHE INSTITUTE OF MEDICAL SCIENCE DEEMED TO BE UNIVERSITY, SAWANGI MEGHE, WARDHA-442107 INDIAN
DR RAJIV BORLE , VICE CHANCELLOR, DATTA MEGHE INSTITUTE OF MEDICAL SCIENCE DEEMED TO BE UNIVERSITY, SAWANGI MEGHE, WARDHA-442107 INDIAN
DR S P THYAGRAJAN , PROF OF EMINENCE, DEAN RESEARCH, SRI RAMACHANDRA INSTITUTE OF HIGHER EDUCATION AND RESEARCH DEEMED TO BE UNIVERSITY, CHENNAI-600116 INDIAN
DR DILIP MHAISEKAR , VICE CHANCELLOR, MAHARASHTRA UNIVERSITY OF HEALTH SCIENCES, NASHIK-422004 INDIAN
DR MOHANAN KUNNUMMAL , VICE CHANCELLOR, KERALA UNIVERSITY OF HEALTH SCIENCES, THRISSUR, KERALA-680596 INDIAN
DR O P KALRA , PT. BHAGWAT DAYAL SHARMA UNIVERSITY OF HEALTH SCIENCES, ROHTAK-124001 INDIAN
DR NEELAM MISHRA , VICE CHANCELLOR, KRISHNA INSTITUTE OF MEDICAL SCIENCES DEEMED TO BE UNIVERSITY, KARAD, MAHARASHTRA, INDIA-415539 INDIAN
12. Names, addresses and nationalities of other persons, if any, authorised to assign or licence of rights comprising the copyright : DR VEDPRAKASH MISHRA , PRO CHANCELLOR, DATTA MEGHE INSTITUTE OF MEDICAL SCIENCE DEEMED TO BE UNIVERSITY, SAWANGI MEGHE, WARDHA-442107 INDIAN
DR LALITBHUSHAN WAGHMARE , PRO VICE CHANCELLOR, DATTA MEGHE INSTITUTE OF MEDICAL SCIENCE DEEMED TO BE UNIVERSITY, SAWANGI MEGHE, WARDHA-442107 INDIAN
DR RAJIV BORLE , VICE CHANCELLOR, DATTA MEGHE INSTITUTE OF MEDICAL SCIENCE DEEMED TO BE UNIVERSITY, SAWANGI MEGHE, WARDHA-442107 INDIAN
DR S P THYAGRAJAN , PROF OF EMINENCE, DEAN RESEARCH, SRI RAMACHANDRA INSTITUTE OF HIGHER EDUCATION AND RESEARCH DEEMED TO BE UNIVERSITY, CHENNAI-600116 INDIAN
DR DILIP MHAISEKAR , VICE CHANCELLOR, MAHARASHTRA UNIVERSITY OF HEALTH SCIENCES, NASHIK-422004 INDIAN
DR MOHANAN KUNNUMMAL , VICE CHANCELLOR, KERALA UNIVERSITY OF HEALTH SCIENCES, THRISSUR, KERALA-680596 INDIAN
DR O P KALRA , PT. BHAGWAT DAYAL SHARMA UNIVERSITY OF HEALTH SCIENCES, ROHTAK-124001 INDIAN
DR NEELAM MISHRA , VICE CHANCELLOR, KRISHNA INSTITUTE OF MEDICAL SCIENCES DEEMED TO BE UNIVERSITY, KARAD, MAHARASHTRA, INDIA-415539 INDIAN
13. If the work is an 'Artistic work', the location of the original work, including name, address and nationality of the person in possession of the work. (In the case of an architectural work, the year of completion of the work should also be shown). : N.A.



DEPT. OF MULTIMEDIA REGISTRY OF COPYRIGHTS

14. If the work is an 'Artistic work' which is used or capable of being used in relation to any goods or services, the application should include a certification from the Registrar of Trade Marks in terms of the provision to Sub-Section (i) of Section 45 of the Copyright Act, 1957. : N.A.
15. If the work is an 'Artistic work', whether it is registered under the Designs Act 2000 if yes give details. : N.A.
16. If the work is an 'Artistic work', capable of being registered as a design under the Designs Act 2000.whether it has been applied to an article though an industrial process and ,if yes ,the number of times it is reproduced. : N.A.
17. Remarks, if any :
- Diary Number : 9348/2020-CO/L
- Date of Application : 10/07/2020
- Date of Receipt : 10/07/2020



[Handwritten Signature]

DEPUTY REGISTRAR OF COPYRIGHTS

Dated : 19/08/2020

1. Registration Number : **CF-4638/2020**
2. Name, address and nationality of the applicant : KRISHNA INSTITUTE OF MEDICAL SCIENCES "DEEMED TO BE UNIVERSITY", KARAD , NH4, PUNE - BANGALORE HIGHWAY, DIST.SATARA, AGASHIVNAGAR, MALKAPUR, MAHARASHTRA-415539 INDIAN
3. Nature of the applicant's interest in the copyright of the work : OWNER
4. Class and description of the work : CINEMATOGRAPH FILM WORK
5. Title of the work : DO NOT USE HEADPHONES AND LISTEN TO LOUD MUSIC WHILE DRIVING
6. Language of the work : ENGLISH
7. Name, address and nationality of the author and if the author is deceased, date of his decease : DR. CHANDRAKANT M KOKATANUR , NH4, PUNE - BANGALORE HIGHWAY, DIST.SATARA, AGASHIVNAGAR, MALKAPUR, MAHARASHTRA-415539 INDIAN
DR AJAY V PATIL , NH4, PUNE - BANGALORE HIGHWAY, DIST.SATARA, AGASHIVNAGAR, MALKAPUR, MAHARASHTRA-415539 INDIAN
DR VINAY BANNUR , NH4, PUNE - BANGALORE HIGHWAY, DIST.SATARA, AGASHIVNAGAR, MALKAPUR, MAHARASHTRA-415539 INDIAN
SWARAJ GANDHI , NH4, PUNE - BANGALORE HIGHWAY, DIST.SATARA, AGASHIVNAGAR, MALKAPUR, MAHARASHTRA-415539 INDIAN
TAMANNA RAI , NH4, PUNE - BANGALORE HIGHWAY, DIST.SATARA, AGASHIVNAGAR, MALKAPUR, MAHARASHTRA-415539 INDIAN
NAZREEN FATEMA , NH4, PUNE - BANGALORE HIGHWAY, DIST.SATARA, AGASHIVNAGAR, MALKAPUR, MAHARASHTRA-415539 INDIAN
8. Whether the work is published or unpublished : UNPUBLISHED
9. Year and country of first publication and name, address and nationality of the publisher : N.A.
10. Years and countries of subsequent publications, if any, and names, addresses and nationalities of the publishers : N.A.
11. Names, addresses and nationalities of the owners of various rights comprising the copyright in the work and the extent of rights held by each, together with particulars of assignments and licences, if any : KRISHNA INSTITUTE OF MEDICAL SCIENCES "DEEMED TO BE UNIVERSITY", KARAD , NH4, PUNE - BANGALORE HIGHWAY, DIST.SATARA, AGASHIVNAGAR, MALKAPUR, MAHARASHTRA-415539 INDIAN
12. Names, addresses and nationalities of other persons, if any, authorised to assign or licence of rights comprising the copyright : KRISHNA INSTITUTE OF MEDICAL SCIENCES "DEEMED TO BE UNIVERSITY", KARAD , NH4, PUNE - BANGALORE HIGHWAY, DIST.SATARA, AGASHIVNAGAR, MALKAPUR, MAHARASHTRA-415539 INDIAN
13. If the work is an 'Artistic work', the location of the original work, including name, address and nationality of the person in possession of the work. (In the case of an architectural work, the year of completion of the work should also be shown) : N.A.
14. If the work is an 'Artistic work' which is used or capable of being used in relation to any goods or services, the application should include a certification from the Registrar of Trade Marks in terms of the provision to Sub-Section (1) of Section 45 of the Copyright Act, 1957 : N.A.
15. If the work is an 'Artistic work', whether it is registered under the Designs Act 2000 if use same details : N.A.

Dated : 15/09/2020

1. Registration Number : **CF-4660/2020**
2. Name, address and nationality of the applicant : KRISHNA INSTITUTE OF MEDICAL SCIENCES "DEEMED TO BE UNIVERSITY", KARAD , NH4, PUNE - BANGALORE HIGHWAY, DIST.SATARA, AGASHIVNAGAR, MALKAPUR, MAHARASHTRA-415539
INDIAN
3. Nature of the applicant's interest in the copyright of the work : OWNER
4. Class and description of the work : CINEMATOGRAPH FILM WORK
5. Title of the work : AUDIO VIDEO PRESENTATION OF HAND WASHING TECHNIQUES
6. Language of the work : ENGLISH, HINDI
7. Name, address and nationality of the author and if the author is deceased. date of his decease : DR. KAPIL MANTK MORE , A/P- SARIID, NAVEEN VASAHAT, TAL-SHAHIWADI, DIST- KOLHAPUR, MAHARASHTRA, INDIA-416214
INDIAN

DR. AJAY V. PATIL , B2/8, STAFF QUARTERS, KIMS CAMPUS, MALKAPUR, KARAD, MAHARASHTRA, INDIA-415539
INDIAN
8. Whether the work is published or unpublished : UNPUBLISHED
9. Year and country of first publication and name, address and nationality of the publisher : N.A.
10. Years and countries of subsequent publications, if any, and names, addresses and nationalities of the publishers : N.A.
11. Names, addresses and nationalities of the owners of various rights comprising the copyright in the work and the extent of rights held by each, together with particulars of assignments and licences, if any : KRISHNA INSTITUTE OF MEDICAL SCIENCES "DEEMED TO BE UNIVERSITY", KARAD , NH4, PUNE - BANGALORE HIGHWAY, DIST.SATARA, AGASHIVNAGAR, MALKAPUR, MAHARASHTRA-415539
INDIAN
12. Names, addresses and nationalities of other persons, if any, authorised to assign or licence of rights comprising the copyright : KRISHNA INSTITUTE OF MEDICAL SCIENCES "DEEMED TO BE UNIVERSITY", KARAD , NH4, PUNE - BANGALORE HIGHWAY, DIST.SATARA, AGASHIVNAGAR, MALKAPUR, MAHARASHTRA-415539
INDIAN
13. If the work is an 'Artistic work', the location of the original work, including name, address and nationality of the person in possession of the work. (In the case of an architectural work, the year of completion of the work should also be shown). : N.A.
14. If the work is an 'Artistic work' which is used or capable of being used in relation to any goods or services, the application should include a certification from the Registrar of Trade Marks in terms of the provision to Sub-Section (i) of Section 45 of the Copyright Act, 1957 : N.A.
15. If the work is an 'Artistic work', whether it is registered under the Designs Act 2000 if yes give details. : N.A.
16. If the work is an 'Artistic work', capable of being registered as a design under the Designs Act 2000, whether it has been applied to an article through an industrial process and if yes the number of times it is reproduced : N.A.

17. Remarks, if any

Diary Number : 10346/2020-CO/CF
Date of Application : 27/07/2020
Date of Receipt : 27/07/2020

DEPUTY REGISTRAR OF COPYRIGHTS

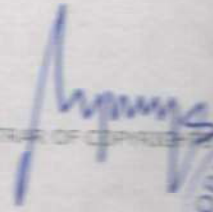

Dated : 15/09/2020

1. Registration Number : **CF-4659/2020**
2. Name, address and nationality of the applicant : KRISHNA INSTITUTE OF MEDICAL SCIENCES "DEEMED TO BE UNIVERSITY", KARAD , NH4, PUNE - BANGALORE HIGHWAY, DIST.SATARA, AGASHIVNAGAR, MALKAPUR, MAHARASHTRA-415539
INDIAN
3. Nature of the applicant's interest in the copyright of the work : OWNER
4. Class and description of the work : CINEMATOGRAPH FILM WORK
5. Title of the work : AUDIO VIDEO PRESENTATION OF TRUTH & MISCONCEPTIONS ABOUT COVID 19
6. Language of the work : ENGLISH, HINDI
7. Name, address and nationality of the author and if the author is deceased, date of his decease : DR. KAPIL MANTK MORE , A/P- SARUD, NAVEEN VASAIAT, TAL-SHAHIWADI, DIST- KOLHAPUR, MAHARASHTRA, INDIA-416214
INDIAN

DR. AJAY V. PATIL , B2/8, STAFF QUARTERS, KIMS CAMPUS, MALKAPUR, KARAD, MAHARASHTRA, INDIA-415539
INDIAN
8. Whether the work is published or unpublished : UNPUBLISHED
9. Year and country of first publication and name, address and nationality of the publisher : N.A.
10. Years and countries of subsequent publications, if any, and names, addresses and nationalities of the publishers : N.A.
11. Names, addresses and nationalities of the owners of various rights comprising the copyright in the work and the extent of rights held by each, together with particulars of assignments and licences, if any : KRISHNA INSTITUTE OF MEDICAL SCIENCES "DEEMED TO BE UNIVERSITY", KARAD , NH4, PUNE - BANGALORE HIGHWAY, DIST.SATARA, AGASHIVNAGAR, MALKAPUR, MAHARASHTRA-415539
INDIAN
12. Names, addresses and nationalities of other persons, if any, authorised to assign or licence of rights comprising the copyright : KRISHNA INSTITUTE OF MEDICAL SCIENCES "DEEMED TO BE UNIVERSITY", KARAD , NH4, PUNE - BANGALORE HIGHWAY, DIST.SATARA, AGASHIVNAGAR, MALKAPUR, MAHARASHTRA-415539
INDIAN
13. If the work is an 'Artistic work', the location of the original work, including name, address and nationality of the person in possession of the work. (In the case of an architectural work, the year of completion of the work should also be shown). : N.A.
14. If the work is an 'Artistic work' which is used or capable of being used in relation to any goods or services, the application should include a certification from the Registrar of Trade Marks in terms of the provision to Sub-Section (1) of Section 45 of the Copyright Act, 1957 : N.A.
15. If the work is an 'Artistic work', whether it is registered under the Designs Act 2000 if yes give details. : N.A.
16. If the work is an 'Artistic work', capable of being registered as a design under the Designs Act 2000, whether it has been applied to an article through an industrial process and : N.A.

16. If the work is an 'Artistic work', capable of being registered as a design under the Designs Act 2000. whether it has been applied to an article through an industrial process and, if yes, the number of times it is reproduced. : N.A.

17. Remarks, if any

Diary Number : 10350/2020-CO/CF
Date of Application : 27/07/2020
Date of Receipt : 27/07/2020

DEPUTY REGISTRAR OF COPYRIGHT





Dated : 27/07/2020

1. Registration Number : **L-93108/2020**
2. Name, address and nationality of the applicant : KRISHNA INSTITUTE OF MEDICAL SCIENCES "DEEMED TO BE UNIVERSITY", KARAD , NH4, PUNE - BANGALORE HIGHWAY, DIST.SATARA, AGASHIVNAGAR, MALKAPUR, MAHARASHTRA-NH4, PUNE - BANGALORE HIGHWAY, DIST.SATARA, AGASHIVNAGAR, MALKAPUR, MAHARASHTRA-415539 INDIAN
3. Nature of the applicant's interest in the copyright of the work : OWNER
4. Class and description of the work : LITERARY/ DRAMATIC WORK
5. Title of the work : SELF-STRUCTURED SCALE FOR EVALUATING COPING STRATEGIES IN MENOPAUSAL WOMEN
6. Language of the work : ENGLISH
7. Name, address and nationality of the author and if the author is deceased, date of his decease : MRS. NUTAN POTDAR , NH4, PUNE - BANGALORE HIGHWAY, DIST.SATARA, AGASHIVNAGAR, MALKAPUR, MAHARASHTRA-NH4, PUNE - BANGALORE HIGHWAY, DIST.SATARA, AGASHIVNAGAR, MALKAPUR, MAHARASHTRA-415539 INDIAN

MRS. VAISHALI MOHITE , NH4, PUNE - BANGALORE HIGHWAY, DIST.SATARA, AGASHIVNAGAR, MALKAPUR, MAHARASHTRA-NH4, PUNE - BANGALORE HIGHWAY, DIST.SATARA, AGASHIVNAGAR, MALKAPUR, MAHARASHTRA-415539 INDIAN
8. Whether the work is published or unpublished : UNPUBLISHED
9. Year and country of first publication and name, address and nationality of the publisher : N.A.
10. Years and countries of subsequent publications, if any, and names, addresses and nationalities of the publishers : N.A.
11. Names, addresses and nationalities of the owners of various rights comprising the copyright in the work and the extent of rights held by each, together with particulars of assignments and licences, if any : KRISHNA INSTITUTE OF MEDICAL SCIENCES "DEEMED TO BE UNIVERSITY", KARAD , NH4, PUNE - BANGALORE HIGHWAY, DIST.SATARA, AGASHIVNAGAR, MALKAPUR, MAHARASHTRA-NH4, PUNE - BANGALORE HIGHWAY, DIST.SATARA, AGASHIVNAGAR, MALKAPUR, MAHARASHTRA-415539 INDIAN
12. Names, addresses and nationalities of other persons, if any, authorised to assign or licence of rights comprising the copyright : KRISHNA INSTITUTE OF MEDICAL SCIENCES "DEEMED TO BE UNIVERSITY", KARAD , NH4, PUNE - BANGALORE HIGHWAY, DIST.SATARA, AGASHIVNAGAR, MALKAPUR, MAHARASHTRA-NH4, PUNE - BANGALORE HIGHWAY, DIST.SATARA, AGASHIVNAGAR, MALKAPUR, MAHARASHTRA-415539 INDIAN
13. If the work is an 'Artistic work', the location of the original work, including the address and nationality of the person in possession of the work, in the case of an architectural work, the year of construction (if any) should also be shown). : N.A.
14. If the work is a 'work' which is used or capable of being used in connection with goods or services, the application should be made to the Registrar of Trade Marks in terms of Section 45 of the Copyright Act, 1957. : N.A.
15. If the work is an 'Artistic work', whether it is registered under the Designs Act 2000 if yes give details. : N.A.
16. If the work is an 'Artistic work', capable of being registered as a design under the Designs Act 2000, whether it has been applied to an article though an industrial process and, if yes, the number of times it is reproduced. : N.A.
17. Remarks, if any :

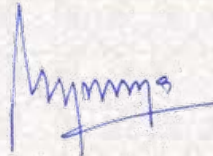
DEPUTY REGISTRAR OF COPYRIGHTS

Diary Number : 7797/2020-CO/L
Date of Application : 13/06/2020
Date of Receipt : 13/06/2020



A handwritten signature in blue ink, appearing to read "M. M. M. S.", is written over a faint rectangular stamp.

DEPUTY REGISTRAR OF COPYRIGHTS



Dated : 19/08/2020

1. Registration Number : **L-93784/2020**
2. Name, address and nationality of the applicant : KRISHNA INSTITUTE OF MEDICAL SCIENCES "DEEMED TO BE UNIVERSITY", KARAD , NH4, PUNE - BANGALORE HIGHWAY, DIST.SATARA, AGASHIVNAGAR, MALKAPUR, MAHARASHTRA-415539 INDIAN
3. Nature of the applicant's interest in the copyright of the work : OWNER
4. Class and description of the work : LITERARY/ DRAMATIC WORK
5. Title of the work : CONCEPTUAL FRAMEWORK FOR "A STUDY TO ASSESS THE KNOWLEDGE ABOUT DECREASING SEX RATIO AND ATTITUDE TOWARDS FEMALE FETICIDE OF PREGNANT WOMEN ATTENDING ANTENATAL CLINIC" BASED ON WIEDENBACHS PERCEPTIVE THEORY (MEETING THE REALITIES IN CLINICAL SETTING)
6. Language of the work : ENGLISH
7. Name, address and nationality of the author and if the author is deceased, date of his decease : DR. JYOTI A. SALUNKHE , KRISHNA INSTITUTE OF MEDICAL SCIENCES "DEEMED TO BE UNIVERSITY", KARAD, NH4, PUNE - BANGALORE HIGHWAY, DIST.SATARA, AGASHIVNAGAR, MALKAPUR, MAHARASHTRA-415539 INDIAN

DR. AVINASH H. SALUNKHE , KRISHNA INSTITUTE OF MEDICAL SCIENCES "DEEMED TO BE UNIVERSITY", KARAD, NH4, PUNE - BANGALORE HIGHWAY, DIST.SATARA, AGASHIVNAGAR, MALKAPUR, MAHARASHTRA-415539 INDIAN
8. Whether the work is published or unpublished : UNPUBLISHED
9. Year and country of first publication and name, address and nationality of the publisher : N.A.
10. Years and countries of subsequent publications, if any, and names, addresses and nationalities of the publishers : N.A.
11. Names, addresses and nationalities of the owners of various rights comprising the copyright in the work and the extent of rights held by each, together with particulars of assignments and licences, if any : KRISHNA INSTITUTE OF MEDICAL SCIENCES "DEEMED TO BE UNIVERSITY", KARAD , NH4, PUNE - BANGALORE HIGHWAY, DIST.SATARA, AGASHIVNAGAR, MALKAPUR, MAHARASHTRA-415539 INDIAN
12. Names, addresses and nationalities of other persons, if any, authorised to assign or licence of rights comprising the copyright : KRISHNA INSTITUTE OF MEDICAL SCIENCES "DEEMED TO BE UNIVERSITY", KARAD , NH4, PUNE - BANGALORE HIGHWAY, DIST.SATARA, AGASHIVNAGAR, MALKAPUR, MAHARASHTRA-415539 INDIAN
13. If the work is an 'Artistic work', the location of the original work, including name, address and nationality of the person in possession of the work. (In the case of an architectural work, the year of completion of the work should also be shown). : N.A.
14. If the work is an 'Artistic work' which is used or capable of being used in connection with any goods or services, the application should be made to the Registrar of Trade Marks in terms of Section (i) of Section 45 of the Copyright Act, : N.A.
15. If the work is an 'Artistic work', whether it is registered under the Designs Act 2000, if yes, give details. : N.A.
16. If the work is an 'Artistic work', capable of being registered as a design under the Designs Act 2000, whether it has been applied to an article by an industrial process and, if yes, the number of times it is reproduced. : N.A.
17. Remarks, if any :

Diary Number : 8555/2020-CO/L

Date of Application : 26/06/2020

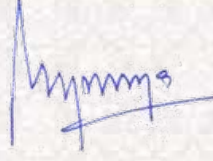
DEPUTY REGISTRAR OF COPYRIGHTS



A handwritten signature in blue ink, appearing to read "M. M. M. S.", is written over a faint rectangular stamp.

DEPUTY REGISTRAR OF COPYRIGHTS



Dated : 03/11/2020

1. Registration Number : **L-96318/2020**
2. Name, address and nationality of the applicant : KRISHNA INSTITUTE OF MEDICAL SCIENCES "DEEMED TO BE UNIVERSITY", KARAD , KRISHNA INSTITUTE OF MEDICAL SCIENCES "DEEMED TO BE UNIVERSITY", KARAD, MALKAPUR, KARAD, DIST. SATARA, MAHARASHTRA, INDIA-415539 INDIAN
3. Nature of the applicant's interest in the copyright of the work : OWNER
4. Class and description of the work : LITERARY/ DRAMATIC WORK
5. Title of the work : RUGAL STAMP
6. Language of the work : ENGLISH
7. Name, address and nationality of the author and if the author is deceased, date of his decease : DR. SHUBHA JOSHI , KRISHNA INSTITUTE OF MEDICAL SCIENCES "DEEMED TO BE UNIVERSITY", KARAD, MALKAPUR, KARAD, DIST. SATARA, MAHARASHTRA, INDIA-415539 INDIAN
DR. OMKAR SAKPAL , KRISHNA INSTITUTE OF MEDICAL SCIENCES "DEEMED TO BE UNIVERSITY", KARAD, MALKAPUR, KARAD, DIST. SATARA, MAHARASHTRA, INDIA-415539 INDIAN
8. Whether the work is published or unpublished : UNPUBLISHED
9. Year and country of first publication and name, address and nationality of the publisher : N.A.
10. Years and countries of subsequent publications, if any, and names, addresses and nationalities of the publishers : N.A.
11. Names, addresses and nationalities of the owners of various rights comprising the copyright in the work and the extent of rights held by each, together with particulars of assignments and licences, if any : KRISHNA INSTITUTE OF MEDICAL SCIENCES "DEEMED TO BE UNIVERSITY", KARAD , KRISHNA INSTITUTE OF MEDICAL SCIENCES "DEEMED TO BE UNIVERSITY", KARAD, MALKAPUR, KARAD, DIST. SATARA, MAHARASHTRA, INDIA-415539 INDIAN
12. Names, addresses and nationalities of other persons, if any, authorised to assign or licence of rights comprising the copyright : N.A.
13. If the work is an 'Artistic work', the location of the original work, including name, address and nationality of the person in possession of the work. (In the case of an architectural work, the year of completion of the work should also be shown). : N.A.
14. If the work is an 'Artistic work' which is used or capable of being used in relation to any goods or services, the application should include a certification from the Registrar of Trade Marks in terms of the provision to Sub-Section (i) of Section 45 of the Copyright Act, 1957. : N.A.
15. If the work is an 'Artistic work', whether it is registered under the Designs Act 2000 if yes give details. : N.A.
16. If the work is an 'Artistic work', capable of being registered as a design under the Designs Act 2000, whether it has been applied to an article or to an industrial process and ,if yes ,the number of times it is : N.A.
17. :



14740/2020-CO/L
02/10/2020
02/10/2020



DEPUTY REGISTRAR OF COPYRIGHTS



Dated : 03/11/2020

1. Registration Number : **L-96343/2020**
2. Name, address and nationality of the applicant : KRISHNA INSTITUTE OF MEDICAL SCIENCES "DEEMED TO BE UNIVERSITY", KARAD , KRISHNA INSTITUTE OF MEDICAL SCIENCES "DEEMED TO BE UNIVERSITY", KARAD, MALKAPUR, KARAD, DIST. SATARA, MAHARASHTRA, INDIA-415539
INDIAN
3. Nature of the applicant's interest in the copyright of the work : OWNER
4. Class and description of the work : LITERARY/ DRAMATIC WORK
5. Title of the work : INTRODUCTION AND CLASSIFICATION OF PRODRUGS
6. Language of the work : ENGLISH
7. Name, address and nationality of the author and if the author is deceased, date of his decease : MRS. MANISHA NITIN VEER , KRISHNA INSTITUTE OF MEDICAL SCIENCES "DEEMED TO BE UNIVERSITY", KARAD, MALKAPUR, KARAD, DIST. SATARA, MAHARASHTRA, INDIA-415539
INDIAN

DR. RAJENDRA C. DOJJAD , KRISHNA INSTITUTE OF MEDICAL SCIENCES "DEEMED TO BE UNIVERSITY", KARAD, MALKAPUR, KARAD, DIST. SATARA, MAHARASHTRA, INDIA-415539
INDIAN
8. Whether the work is published or unpublished : UNPUBLISHED
9. Year and country of first publication and name, address and nationality of the publisher : N.A.
10. Years and countries of subsequent publications, if any, and names, addresses and nationalities of the publishers : N.A.
11. Names, addresses and nationalities of the owners of various rights comprising the copyright in the work and the extent of rights held by each, together with particulars of assignments and licences, if any : KRISHNA INSTITUTE OF MEDICAL SCIENCES "DEEMED TO BE UNIVERSITY", KARAD , KRISHNA INSTITUTE OF MEDICAL SCIENCES "DEEMED TO BE UNIVERSITY", KARAD, MALKAPUR, KARAD, DIST. SATARA, MAHARASHTRA, INDIA-415539
INDIAN
12. Names, addresses and nationalities of other persons, if any, authorised to assign or licence of rights comprising the copyright : N.A.
13. If the work is an 'Artistic work', the location of the original work, including name, address and nationality of the person in possession of the work. (In the case of an architectural work, the year of completion of the work should also be shown). : N.A.
14. If the work is an 'Artistic work' which is used or capable of being used in relation to any goods or services, the application should include a certification from the Registrar of Trade Marks in terms of the provision to Sub-Section (i) of Section 45 of the Copyright Act, 1957. : N.A.
15. If the work is an 'Artistic work', whether it is registered under the Designs Act 2000 if yes give details. : N.A.
16. If the work is an 'Artistic work', capable of being registered as a design under the Designs Act 2000, whether it has been applied to an article or to an industrial process and ,if yes ,the number of times it is : N.A.
17. :



14735/2020-CO/L
02/10/2020
02/10/2020



DEPUTY REGISTRAR OF COPYRIGHTS



Dated : 03/11/2020

1. Registration Number : **L-96342/2020**
2. Name, address and nationality of the applicant : KRISHNA INSTITUTE OF MEDICAL SCIENCES "DEEMED TO BE UNIVERSITY", KARAD , KRISHNA INSTITUTE OF MEDICAL SCIENCES "DEEMED TO BE UNIVERSITY", KARAD, MALKAPUR, KARAD, DIST. SATARA, MAHARASHTRA, INDIA-415539 INDIAN
3. Nature of the applicant's interest in the copyright of the work : OWNER
4. Class and description of the work : LITERARY/ DRAMATIC WORK
5. Title of the work : MECHANISM OF ACTION OF NITROGEN MUSTARD (ANTINEOPLASTIC AGENT)
6. Language of the work : ENGLISH
7. Name, address and nationality of the author and if the author is deceased, date of his decease : MRS. MANISHA NITIN VEER , KRISHNA INSTITUTE OF MEDICAL SCIENCES "DEEMED TO BE UNIVERSITY", KARAD, MALKAPUR, KARAD, DIST. SATARA, MAHARASHTRA, INDIA-415539 INDIAN
DR. RAJENDRA C. DOIJAD , KRISHNA INSTITUTE OF MEDICAL SCIENCES "DEEMED TO BE UNIVERSITY", KARAD, MALKAPUR, KARAD, DIST. SATARA, MAHARASHTRA, INDIA-415539 INDIAN
8. Whether the work is published or unpublished : UNPUBLISHED
9. Year and country of first publication and name, address and nationality of the publisher : N.A.
10. Years and countries of subsequent publications, if any, and names, addresses and nationalities of the publishers : N.A.
11. Names, addresses and nationalities of the owners of various rights comprising the copyright in the work and the extent of rights held by each, together with particulars of assignments and licences, if any : KRISHNA INSTITUTE OF MEDICAL SCIENCES "DEEMED TO BE UNIVERSITY", KARAD , KRISHNA INSTITUTE OF MEDICAL SCIENCES "DEEMED TO BE UNIVERSITY", KARAD, MALKAPUR, KARAD, DIST. SATARA, MAHARASHTRA, INDIA-415539 INDIAN
12. Names, addresses and nationalities of other persons, if any, authorised to assign or licence of rights comprising the copyright : N.A.
13. If the work is an 'Artistic work', the location of the original work, including name, address and nationality of the person in possession of the work. (In the case of an architectural work, the year of completion of the work should also be shown). : N.A.
14. If the work is an 'Artistic work' which is used or capable of being used in relation to any goods or services, the application should include a certification from the Registrar of Trade Marks in terms of the provision to Sub-Section (i) of Section 45 of the Copyright Act, 1957. : N.A.
15. If the work is an 'Artistic work', whether it is registered under the Designs Act 2000 if yes give details. : N.A.
16. If the work is an 'Artistic work', capable of being registered as a design under the Designs Act 2000, whether it has been applied to an article, industrial process and ,if yes ,the number of times : N.A.
17. :



14736/2020-CO/L

02/10/2020

Date

02/10/2020



DEPUTY REGISTRAR OF COPYRIGHTS



Dated : 09/11/2020

- | | | |
|--|---|--|
| 1. Registration Number | : | CF-4738/2020 |
| 2. Name, address and nationality of the applicant | : | KRISHNA INSTITUTE OF MEDICAL SCIENCES "DEEMED TO BE UNIVERSITY", KARAD , NH4, PUNE - BANGALORE HIGHWAY, DIST.SATARA, AGASHIVNAGAR, MALKAPUR, MAHARASHTRA-415539 INDIAN |
| 3. Nature of the applicant's interest in the copyright of the work | : | OWNER |
| 4. Class and description of the work | : | CINEMATOGRAPH FILM WORK |
| 5. Title of the work | : | FORENSIC MEDICINE AND TOXICOLOGY MOOT COURT 2020 |
| 6. Language of the work | : | ENGLISH, HINDI |
| 7. Name, address and nationality of the author and if the author is deceased, date of his decease | : | DR.CHANDRAKANT M KOKATANUR , NH4, PUNE - BANGALORE HIGHWAY, DIST.SATARA, AGASHIVNAGAR, MALKAPUR, MAHARASHTRA-415539 INDIAN

DR. AJAY PATIL , NH4, PUNE - BANGALORE HIGHWAY, DIST.SATARA, AGASHIVNAGAR, MALKAPUR, MAHARASHTRA-415539 INDIAN

DR. VINAY BANNUR , NH4, PUNE - BANGALORE HIGHWAY, DIST.SATARA, AGASHIVNAGAR, MALKAPUR, MAHARASHTRA-415539 INDIAN

DR. KAPIL M MORE , NH4, PUNE - BANGALORE HIGHWAY, DIST.SATARA, AGASHIVNAGAR, MALKAPUR, MAHARASHTRA-415539 INDIAN |
| 8. Whether the work is published or unpublished | : | UNPUBLISHED |
| 9. Year and country of first publication and name, address and nationality of the publisher | : | N.A. |
| 10. Years and countries of subsequent publications, if any, and names, addresses and nationalities of the publishers | : | N.A. |
| 11. Names, addresses and nationalities of the owners of various rights comprising the copyright in the work and the extent of rights held by each, together with particulars of assignments and licences, if any | : | KRISHNA INSTITUTE OF MEDICAL SCIENCES "DEEMED TO BE UNIVERSITY", KARAD , NH4, PUNE - BANGALORE HIGHWAY, DIST.SATARA, AGASHIVNAGAR, MALKAPUR, MAHARASHTRA-415539 INDIAN |
| 12. Names, addresses and nationalities of other persons, if any, authorised to assign or licence of rights comprising the copyright | : | KRISHNA INSTITUTE OF MEDICAL SCIENCES "DEEMED TO BE UNIVERSITY", KARAD , NH4, PUNE - BANGALORE HIGHWAY, DIST.SATARA, AGASHIVNAGAR, MALKAPUR, MAHARASHTRA-415539 INDIAN |
| 13. If the work is an 'Artistic work', the location of the original work, including the address and nationality of the person in possession of the original work, and in the case of an architectural work, the year of construction (if any) should also be shown). | : | N.A. |
| 14. If the work is a 'work' which is used or capable of being used in goods or services, the application should be filed with the Registrar of Trade Marks in terms of Section (i) of Section 45 of the Copyright Act, | : | N.A. |
| 15. If the work is an 'Artistic work', whether it is registered under the Designs Act 2000 if yes give details. | : | N.A. |
| 16. If the work is an 'Artistic work', capable of being registered as a design under the Designs Act 2000.whether it has been applied to an article though an industrial process and ,if yes ,the number of times it is reproduced. | : | N.A. |
| 17. Remarks, if any | : | |



DEPUTY REGISTRAR OF COPYRIGHTS

Diary Number : 10514/2020-CO/CF
Date of Application : 30/07/2020
Date of Receipt : 30/07/2020



A handwritten signature in blue ink, appearing to be "M. M. M. S.", is written over a faint rectangular stamp.

DEPUTY REGISTRAR OF COPYRIGHTS



Dated : 09/11/2020

1. Registration Number : **L-96569/2020**
2. Name, address and nationality of the applicant : KRISHNA INSTITUTE OF MEDICAL SCIENCES "DEEMED TO BE UNIVERSITY", KARAD , KRISHNA INSTITUTE OF MEDICAL SCIENCES "DEEMED TO BE UNIVERSITY", KARAD, MALKAPUR, KARAD, DIST. SATARA, MAHARASHTRA, INDIA-415539
INDIAN
3. Nature of the applicant's interest in the copyright of the work : OWNER
4. Class and description of the work : LITERARY/ DRAMATIC WORK
5. Title of the work : FUNDAMENTALS OF ACTION RESEARCH
6. Language of the work : ENGLISH
7. Name, address and nationality of the author and if the author is deceased, date of his decease : MR. MAHENDRA ALATE , KRISHNA INSTITUTE OF MEDICAL SCIENCES "DEEMED TO BE UNIVERSITY", KARAD, MALKAPUR, KARAD, DIST. SATARA, MAHARASHTRA, INDIA-415539
INDIAN

MR. DHIRAJKUMAR A. MANE , KRISHNA INSTITUTE OF MEDICAL SCIENCES "DEEMED TO BE UNIVERSITY", KARAD, MALKAPUR, KARAD, DIST. SATARA, MAHARASHTRA, INDIA-415539
INDIAN
8. Whether the work is published or unpublished : UNPUBLISHED
9. Year and country of first publication and name, address and nationality of the publisher : N.A.
10. Years and countries of subsequent publications, if any, and names, addresses and nationalities of the publishers : N.A.
11. Names, addresses and nationalities of the owners of various rights comprising the copyright in the work and the extent of rights held by each, together with particulars of assignments and licences, if any : KRISHNA INSTITUTE OF MEDICAL SCIENCES "DEEMED TO BE UNIVERSITY", KARAD , KRISHNA INSTITUTE OF MEDICAL SCIENCES "DEEMED TO BE UNIVERSITY", KARAD, MALKAPUR, KARAD, DIST. SATARA, MAHARASHTRA, INDIA-415539
INDIAN
12. Names, addresses and nationalities of other persons, if any, authorised to assign or licence of rights comprising the copyright : N.A.
13. If the work is an 'Artistic work', the location of the original work, including name, address and nationality of the person in possession of the work. (In the case of an architectural work, the year of completion of the work should also be shown). : N.A.
14. If the work is an 'Artistic work' which is used or capable of being used in relation to any goods or services, the application should include a certification from the Registrar of Trade Marks in terms of the provision to Sub-Section (i) of Section 45 of the Copyright Act, 1957. : N.A.
15. If the work is an 'Artistic work', whether it is registered under the Designs Act 2000 if yes give details. : N.A.
16. If the work is an 'Artistic work', capable of being registered as a design under the Designs Act 2000, whether it has been applied to an article or to an industrial process and ,if yes ,the number of times it is : N.A.
17. :



14742/2020-CO/L
02/10/2020
02/10/2020



DEPUTY REGISTRAR OF COPYRIGHTS



Dated : 09/11/2020

1. Registration Number : **CF-4739/2020**
2. Name, address and nationality of the applicant : KRISHNA INSTITUTE OF MEDICAL SCIENCES "DEEMED TO BE UNIVERSITY", KARAD , NH4, PUNE - BANGALORE HIGHWAY, DIST.SATARA, AGASHIVNAGAR, MALKAPUR, MAHARASHTRA-415539 INDIAN
3. Nature of the applicant's interest in the copyright of the work : OWNER
4. Class and description of the work : CINEMATOGRAPH FILM WORK
5. Title of the work : SHORT FILM ON RESPONSIBILITIES OF PEOPLE IN COVID 19 PANDEMIC
6. Language of the work : HINDI
7. Name, address and nationality of the author and if the author is deceased, date of his decease : DR. KAPIL MANIK MORE , A/P- SARUD, NAVEEN VASAHAT, TAL-SHAHUWADI, DIST-KOLHAPUR,MAHARASHTRA, INDIA-416214 INDIAN
DR. AJAY V. PATIL , B2/8, STAFF QUARTERS, KIMS CAMPUS, MALKAPUR, KARAD, MAHARASHTRA, INDIA-415539 INDIAN
8. Whether the work is published or unpublished : UNPUBLISHED
9. Year and country of first publication and name, address and nationality of the publisher : N.A.
10. Years and countries of subsequent publications, if any, and names, addresses and nationalities of the publishers : N.A.
11. Names, addresses and nationalities of the owners of various rights comprising the copyright in the work and the extent of rights held by each, together with particulars of assignments and licences, if any : KRISHNA INSTITUTE OF MEDICAL SCIENCES "DEEMED TO BE UNIVERSITY", KARAD , NH4, PUNE - BANGALORE HIGHWAY, DIST.SATARA, AGASHIVNAGAR, MALKAPUR, MAHARASHTRA-415539 INDIAN
12. Names, addresses and nationalities of other persons, if any, authorised to assign or licence of rights comprising the copyright : KRISHNA INSTITUTE OF MEDICAL SCIENCES "DEEMED TO BE UNIVERSITY", KARAD , NH4, PUNE - BANGALORE HIGHWAY, DIST.SATARA, AGASHIVNAGAR, MALKAPUR, MAHARASHTRA-415539 INDIAN
13. If the work is an 'Artistic work', the location of the original work, including name, address and nationality of the person in possession of the work. (In the case of an architectural work, the year of completion of the work should also be shown). : N.A.
14. If the work is an 'Artistic work' which is used or capable of being used in relation to any goods or services, the application should include a certification from the Registrar of Trade Marks in terms of the provision to Sub-Section (i) of Section 45 of the Copyright Act, 1957. : N.A.
15. If the work is an 'Artistic work', whether it is registered under the Designs Act 2000 if yes give details. : N.A.
16. If the work is an 'Artistic work', capable of being registered as a design under the Designs Act 2000, whether it has been applied to an industrial process and, if yes, the number of times : N.A.
17. :



10351/2020-CO/CF

Date of Receipt : 27/07/2020

Date of Receipt : 27/07/2020

DEPUTY REGISTRAR OF COPYRIGHTS



Dated : 10/11/2020

1. Registration Number : **L-96627/2020**
2. Name, address and nationality of the applicant : KRISHNA INSTITUTE OF MEDICAL SCIENCES "DEEMED TO BE UNIVERSITY", KARAD , KRISHNA INSTITUTE OF MEDICAL SCIENCES "DEEMED TO BE UNIVERSITY", KARAD, MALKAPUR, KARAD, DIST. SATARA, MAHARASHTRA, INDIA-415539
INDIAN
3. Nature of the applicant's interest in the copyright of the work : OWNER
4. Class and description of the work : LITERARY/ DRAMATIC WORK
5. Title of the work : TABLES FOR CALCULATION OF SOLUBILITY PARAMETERS OF ALBENDAZOLE BY DIFFERENT METHODS
6. Language of the work : ENGLISH
7. Name, address and nationality of the author and if the author is deceased, date of his decease : DR. AMOL S.SHETE , KRISHNA INSTITUTE OF MEDICAL SCIENCES "DEEMED TO BE UNIVERSITY", KARAD, MALKAPUR, KARAD, DIST. SATARA, MAHARASHTRA, INDIA-415539
INDIAN

DR. RAJENDRA C. DOJAD , KRISHNA INSTITUTE OF MEDICAL SCIENCES "DEEMED TO BE UNIVERSITY", KARAD, MALKAPUR, KARAD, DIST. SATARA, MAHARASHTRA, INDIA-415539
INDIAN
8. Whether the work is published or unpublished : UNPUBLISHED
9. Year and country of first publication and name, address and nationality of the publisher : N.A.
10. Years and countries of subsequent publications, if any, and names, addresses and nationalities of the publishers : N.A.
11. Names, addresses and nationalities of the owners of various rights comprising the copyright in the work and the extent of rights held by each, together with particulars of assignments and licences, if any : KRISHNA INSTITUTE OF MEDICAL SCIENCES "DEEMED TO BE UNIVERSITY", KARAD , KRISHNA INSTITUTE OF MEDICAL SCIENCES "DEEMED TO BE UNIVERSITY", KARAD, MALKAPUR, KARAD, DIST. SATARA, MAHARASHTRA, INDIA-415539
INDIAN
12. Names, addresses and nationalities of other persons, if any, authorised to assign or licence of rights comprising the copyright : N.A.
13. If the work is an 'Artistic work', the location of the original work, including name, address and nationality of the person in possession of the work. (In the case of an architectural work, the year of completion of the work should also be shown). : N.A.
14. If the work is an 'Artistic work' which is used or capable of being used in relation to any goods or services, the application should include a certification from the Registrar of Trade Marks in terms of the provision to Sub-Section (i) of Section 45 of the Copyright Act, 1957. : N.A.
15. If the work is an 'Artistic work', whether it is registered under the Designs Act 2000 if yes give details. : N.A.
16. If the work is an 'Artistic work', capable of being registered as a design under the Designs Act 2000, whether it has been applied to an article, the number of times it has been applied to an industrial process and ,if yes ,the number of times : N.A.



14235/2020-CO/L

25/09/2020

Date of registration : 25/09/2020

DEPUTY REGISTRAR OF COPYRIGHTS



Dated : 11/11/2020

1. Registration Number : **L-96671/2020**
2. Name, address and nationality of the applicant : KRISHNA INSTITUTE OF MEDICAL SCIENCES "DEEMED TO BE UNIVERSITY", KARAD , KRISHNA INSTITUTE OF MEDICAL SCIENCES "DEEMED TO BE UNIVERSITY", KARAD, MALKAPUR, KARAD, DIST. SATARA, MAHARASHTRA, INDIA-415539 INDIAN
3. Nature of the applicant's interest in the copyright of the work : OWNER
4. Class and description of the work : LITERARY/ DRAMATIC WORK
5. Title of the work : TABLES FOR CALCULATION OF SOLUBILITY PARAMETERS OF ITRACONAZOLE BY DIFFERENT METHODS
6. Language of the work : ENGLISH
7. Name, address and nationality of the author and if the author is deceased, date of his decease : DR. AMOL S.SHETE , KRISHNA INSTITUTE OF MEDICAL SCIENCES "DEEMED TO BE UNIVERSITY", KARAD, MALKAPUR, KARAD, DIST. SATARA, MAHARASHTRA, INDIA-415539 INDIAN
DR. RAJENDRA C.DOIJAD , KRISHNA INSTITUTE OF MEDICAL SCIENCES "DEEMED TO BE UNIVERSITY", KARAD, MALKAPUR, KARAD, DIST. SATARA, MAHARASHTRA, INDIA-415539 INDIAN
8. Whether the work is published or unpublished : UNPUBLISHED
9. Year and country of first publication and name, address and nationality of the publisher : N.A.
10. Years and countries of subsequent publications, if any, and names, addresses and nationalities of the publishers : N.A.
11. Names, addresses and nationalities of the owners of various rights comprising the copyright in the work and the extent of rights held by each, together with particulars of assignments and licences, if any : KRISHNA INSTITUTE OF MEDICAL SCIENCES "DEEMED TO BE UNIVERSITY", KARAD , KRISHNA INSTITUTE OF MEDICAL SCIENCES "DEEMED TO BE UNIVERSITY", KARAD, MALKAPUR, KARAD, DIST. SATARA, MAHARASHTRA, INDIA-415539 INDIAN
12. Names, addresses and nationalities of other persons, if any, authorised to assign or licence of rights comprising the copyright : N.A.
13. If the work is an 'Artistic work', the location of the original work, including name, address and nationality of the person in possession of the work. (In the case of an architectural work, the year of completion of the work should also be shown). : N.A.
14. If the work is an 'Artistic work' which is used or capable of being used in relation to any goods or services, the application should include a certification from the Registrar of Trade Marks in terms of the provision to Sub-Section (i) of Section 45 of the Copyright Act, 1957. : N.A.
15. If the work is an 'Artistic work', whether it is registered under the Designs Act 2000 if yes give details. : N.A.
16. If the work is an 'Artistic work', capable of being registered as a design under the Designs Act 2000, whether it has been applied to an article, the number of times it has been applied to an industrial process and ,if yes ,the number of times : N.A.



14234/2020-CO/L

25/09/2020

Date of registration : 25/09/2020

DEPUTY REGISTRAR OF COPYRIGHTS



Dated : 27/08/2020

1. Registration Number : **L-94157/2020**
2. Name, address and nationality of the applicant : KRISHNA INSTITUTE OF MEDICAL SCIENCES "DEEMED TO BE UNIVERSITY", KARAD , NH4, PUNE - BANGALORE HIGHWAY, DIST.SATARA, AGASHIVNAGAR, MALKAPUR, MAHARASHTRA-415539 INDIAN
3. Nature of the applicant's interest in the copyright of the work : OWNER
4. Class and description of the work : LITERARY/ DRAMATIC WORK
5. Title of the work : IASTM COMBINED THROWER'S TEN EXERCISE PROTOCOL
6. Language of the work : ENGLISH
7. Name, address and nationality of the author and if the author is deceased, date of his decease : DR.PRASANNAJEET PRAMOD NIKAM , KRISHNA INSTITUTE OF MEDICAL SCIENCES DEEMED TO BE UNIVERSITY, NEAR DHEBEWADI ROAD, MALKAPUR TAL – KARAD-415539 INDIAN
DR.G.VARADHARAJULU , KRISHNA INSTITUTE OF MEDICAL SCIENCES DEEMED TO BE UNIVERSITY, NEAR DHEBEWADI ROAD, MALKAPUR TAL – KARAD-415539 INDIAN
8. Whether the work is published or unpublished : UNPUBLISHED
9. Year and country of first publication and name, address and nationality of the publisher : N.A.
10. Years and countries of subsequent publications, if any, and names, addresses and nationalities of the publishers : N.A.
11. Names, addresses and nationalities of the owners of various rights comprising the copyright in the work and the extent of rights held by each, together with particulars of assignments and licences, if any : KRISHNA INSTITUTE OF MEDICAL SCIENCES "DEEMED TO BE UNIVERSITY", KARAD , NH4, PUNE - BANGALORE HIGHWAY, DIST.SATARA, AGASHIVNAGAR, MALKAPUR, MAHARASHTRA-415539 INDIAN
12. Names, addresses and nationalities of other persons, if any, authorised to assign or licence of rights comprising the copyright : KRISHNA INSTITUTE OF MEDICAL SCIENCES "DEEMED TO BE UNIVERSITY", KARAD , NH4, PUNE - BANGALORE HIGHWAY, DIST.SATARA, AGASHIVNAGAR, MALKAPUR, MAHARASHTRA-415539 INDIAN
13. If the work is an 'Artistic work', the location of the original work, including name, address and nationality of the person in possession of the work. (In the case of an architectural work, the year of completion of the work should also be shown). : N.A.
14. If the work is an 'Artistic work' which is used or capable of being used in relation to any goods or services, the application should include a certification from the Registrar of Trade Marks in terms of the provision to Sub-Section (i) of Section 45 of the Copyright Act, 1957. : N.A.
15. If the work is an 'Artistic work', whether it is registered under the Designs Act, 2000 if yes give details. : N.A.
16. If the work is an 'Artistic work', capable of being registered as a design under the Designs Act 2000.whether it has been applied to an article, the date of application, the date of registration, the date of publication and ,if yes ,the number of times : N.A.
17. :



10057/2020-CO/L
Date of Registration : 22/07/2020
Date of Receipt : 22/07/2020

DEPUTY REGISTRAR OF COPYRIGHTS



Dated : 04/11/2020

1. Registration Number : **L-96438/2020**
2. Name, address and nationality of the applicant : KRISHNA INSTITUTE OF MEDICAL SCIENCES "DEEMED TO BE UNIVERSITY", KARAD , KRISHNA INSTITUTE OF MEDICAL SCIENCES "DEEMED TO BE UNIVERSITY", KARAD, MALKAPUR, KARAD, DIST. SATARA, MAHARASHTRA, INDIA-415539
INDIAN
3. Nature of the applicant's interest in the copyright of the work : OWNER
4. Class and description of the work : LITERARY/ DRAMATIC WORK AN ARTICLE
INTERDISCIPLINARY CASE PRESENTATIONS
5. Title of the work : INTERDISCIPLINARY POST GRADUATE CASE
PRESENTATIONS
6. Language of the work : ENGLISH
7. Name, address and nationality of the author and if the author is deceased, date of his decease : DR. APURVA KALE , KRISHNA INSTITUTE OF MEDICAL SCIENCES "DEEMED TO BE UNIVERSITY", KARAD, MALKAPUR, KARAD, DIST. SATARA, MAHARASHTRA, INDIA-415539
INDIAN

DR. SHASHIKIRAN N.D. , KRISHNA INSTITUTE OF MEDICAL SCIENCES "DEEMED TO BE UNIVERSITY", KARAD, MALKAPUR, KARAD, DIST. SATARA, MAHARASHTRA, INDIA-415539
INDIAN
8. Whether the work is published or unpublished : UNPUBLISHED
9. Year and country of first publication and name, address and nationality of the publisher : N.A.
10. Years and countries of subsequent publications, if any, and names, addresses and nationalities of the publishers : N.A.
11. Names, addresses and nationalities of the owners of various rights comprising the copyright in the work and the extent of rights held by each, together with particulars of assignments and licences, if any : KRISHNA INSTITUTE OF MEDICAL SCIENCES "DEEMED TO BE UNIVERSITY", KARAD , KRISHNA INSTITUTE OF MEDICAL SCIENCES "DEEMED TO BE UNIVERSITY", KARAD, MALKAPUR, KARAD, DIST. SATARA, MAHARASHTRA, INDIA-415539
INDIAN
12. Names, addresses and nationalities of other persons, if any, authorised to assign or licence of rights comprising the copyright : N.A.
13. If the work is an 'Artistic work', the location of the original work, including name, address and nationality of the person in possession of the work. (In the case of an architectural work, the year of completion of the work should also be shown). : N.A.
14. If the work is an 'Artistic work' which is used or capable of being used in relation to any goods or services, the application should include a certification from the Registrar of Trade Marks in terms of the provision to Sub-Section (i) of Section 45 of the Copyright Act, 1957. : N.A.
15. If the work is an 'Artistic work', whether it is registered under the Designs Act 2000 if yes give details. : N.A.
16. If the work is an 'Artistic work', capable of being registered as a design under the Designs Act 2000, whether it has been applied to an article, if yes, the number of times : N.A.
17. :



14798/2020-CO/L

03/10/2020

Date of registration : 03/10/2020



DEPUTY REGISTRAR OF COPYRIGHTS



Dated : 04/11/2020

1. Registration Number : **L-96437/2020**
2. Name, address and nationality of the applicant : KRISHNA INSTITUTE OF MEDICAL SCIENCES "DEEMED TO BE UNIVERSITY", KARAD , KRISHNA INSTITUTE OF MEDICAL SCIENCES "DEEMED TO BE UNIVERSITY", KARAD, MALKAPUR, KARAD, DIST. SATARA, MAHARASHTRA, INDIA-415539
INDIAN
3. Nature of the applicant's interest in the copyright of the work : OWNER
4. Class and description of the work : LITERARY/ DRAMATIC WORK AN ARTICLE ON AN INITIATIVE OF STUDENT OF THE WEEK
5. Title of the work : "STUDENT OF THE WEEK"- AN INITIATIVE TO BOOST UP KNOWLEDGE AND CONFIDENCE AMONG UNDERGRADUATE STUDENTS
6. Language of the work : ENGLISH
7. Name, address and nationality of the author and if the author is deceased, date of his decease : DR. SHASHIKIRAN N. D. , KRISHNA INSTITUTE OF MEDICAL SCIENCES "DEEMED TO BE UNIVERSITY", KARAD, MALKAPUR, KARAD, DIST. SATARA, MAHARASHTRA, INDIA-415539
INDIAN

DR. KAMALA K. A. , KRISHNA INSTITUTE OF MEDICAL SCIENCES "DEEMED TO BE UNIVERSITY", KARAD, MALKAPUR, KARAD, DIST. SATARA, MAHARASHTRA, INDIA-415539
INDIAN
8. Whether the work is published or unpublished : UNPUBLISHED
9. Year and country of first publication and name, address and nationality of the publisher : N.A.
10. Years and countries of subsequent publications, if any, and names, addresses and nationalities of the publishers : N.A.
11. Names, addresses and nationalities of the owners of various rights comprising the copyright in the work and the extent of rights held by each, together with particulars of assignments and licences, if any : KRISHNA INSTITUTE OF MEDICAL SCIENCES "DEEMED TO BE UNIVERSITY", KARAD , KRISHNA INSTITUTE OF MEDICAL SCIENCES "DEEMED TO BE UNIVERSITY", KARAD, MALKAPUR, KARAD, DIST. SATARA, MAHARASHTRA, INDIA-415539
INDIAN
12. Names, addresses and nationalities of other persons, if any, authorised to assign or licence of rights comprising the copyright : N.A.
13. If the work is an 'Artistic work', the location of the original work, including name, address and nationality of the person in possession of the work. (In the case of an architectural work, the year of completion of the work should also be shown). : N.A.
14. If the work is an 'Artistic work' which is used or capable of being used in relation to any goods or services, the application should include a certification from the Registrar of Trade Marks in terms of the provision to Sub-Section (i) of Section 45 of the Copyright Act, 1957. : N.A.
15. If the work is an 'Artistic work', whether it is registered under the Designs Act 2000 if yes give details. : N.A.
16. If the work is an 'Artistic work', capable of being registered as a design under the Designs Act 2000, whether it has been applied to an article, the date of application, the date of registration, if any, the date of the design process and ,if yes ,the number of times : N.A.
17. :



14800/2020-CO/L

Date of Receipt : 03/10/2020

Date of Receipt : 03/10/2020



DEPUTY REGISTRAR OF COPYRIGHTS



Dated : 04/11/2020

1. Registration Number : **L-96436/2020**
2. Name, address and nationality of the applicant : KRISHNA INSTITUTE OF MEDICAL SCIENCES "DEEMED TO BE UNIVERSITY", KARAD , KRISHNA INSTITUTE OF MEDICAL SCIENCES "DEEMED TO BE UNIVERSITY", KARAD, MALKAPUR, KARAD, DIST. SATARA, MAHARASHTRA, INDIA-415539 INDIAN
3. Nature of the applicant's interest in the copyright of the work : OWNER
4. Class and description of the work : LITERARY/ DRAMATIC WORK A POEM
5. Title of the work : POEM- AT THE END OF THE DAY
6. Language of the work : ENGLISH
7. Name, address and nationality of the author and if the author is deceased, date of his decease : DR. PRASHANT A. PUNDE , KRISHNA INSTITUTE OF MEDICAL SCIENCES "DEEMED TO BE UNIVERSITY", KARAD, MALKAPUR, KARAD, DIST. SATARA, MAHARASHTRA, INDIA-415539 INDIAN
8. Whether the work is published or unpublished : UNPUBLISHED
9. Year and country of first publication and name, address and nationality of the publisher : N.A.
10. Years and countries of subsequent publications, if any, and names, addresses and nationalities of the publishers : N.A.
11. Names, addresses and nationalities of the owners of various rights comprising the copyright in the work and the extent of rights held by each, together with particulars of assignments and licences, if any : KRISHNA INSTITUTE OF MEDICAL SCIENCES "DEEMED TO BE UNIVERSITY", KARAD , KRISHNA INSTITUTE OF MEDICAL SCIENCES "DEEMED TO BE UNIVERSITY", KARAD, MALKAPUR, KARAD, DIST. SATARA, MAHARASHTRA, INDIA-415539 INDIAN
12. Names, addresses and nationalities of other persons, if any, authorised to assign or licence of rights comprising the copyright : N.A.
13. If the work is an 'Artistic work', the location of the original work, including name, address and nationality of the person in possession of the work. (In the case of an architectural work, the year of completion of the work should also be shown). : N.A.
14. If the work is an 'Artistic work' which is used or capable of being used in relation to any goods or services, the application should include a certification from the Registrar of Trade Marks in terms of the provision to Sub-Section (i) of Section 45 of the Copyright Act, 1957. : N.A.
15. If the work is an 'Artistic work', whether it is registered under the Designs Act 2000 if yes give details. : N.A.
16. If the work is an 'Artistic work', capable of being registered as a design under the Designs Act 2000.whether it has been applied to an article though an industrial process and ,if yes ,the number of times it is reproduced. : N.A.
17. Remarks, if any :

Diary Number : 14803/2020-CO/L

Date : 03/10/2020

03/10/2020





DEPUTY REGISTRAR OF COPYRIGHTS



Dated : 12/11/2020

1. Registration Number : **L-96693/2020**
2. Name, address and nationality of the applicant : KRISHNA INSTITUTE OF MEDICAL SCIENCES DEEMED TO BE UNIVERSITY, KARAD, MAHARASHTRA , KRISHNA INSTITUTE OF MEDICAL SCIENCES "DEEMED TO BE UNIVERSITY" NEAR DHEBEWADI ROAD, MALKAPUR, TAL-KARAD, DIST: SATARA, MAHARASHTRA, INDIA-415539
INDIAN
3. Nature of the applicant's interest in the copyright of the work : OWNER
4. Class and description of the work : LITERARY/ DRAMATIC WORK
5. Title of the work : BEING A TEACHER
6. Language of the work : ENGLISH
7. Name, address and nationality of the author and if the author is deceased, date of his decease : DR GIRISH SURAGIMATH , DEPARTMENT OF PERIODONTOLOGY, SCHOOL OF DENTAL SCIENCES, KRISHNA INSTITUTE OF MEDICAL SCIENCES "DEEMED TO BE UNIVERSITY", KARAD-415539
INDIAN

DR ASHWINI RANI SR , DEPARTMENT OF PERIODONTOLOGY, SCHOOL OF DENTAL SCIENCES, KRISHNA INSTITUTE OF MEDICAL SCIENCES "DEEMED TO BE UNIVERSITY", KARAD-415539
INDIAN
8. Whether the work is published or unpublished : UNPUBLISHED
9. Year and country of first publication and name, address and nationality of the publisher : N.A.
10. Years and countries of subsequent publications, if any, and names, addresses and nationalities of the publishers : N.A.
11. Names, addresses and nationalities of the owners of various rights comprising the copyright in the work and the extent of rights held by each, together with particulars of assignments and licences, if any : KRISHNA INSTITUTE OF MEDICAL SCIENCES DEEMED TO BE UNIVERSITY, KARAD, MAHARASHTRA , KRISHNA INSTITUTE OF MEDICAL SCIENCES "DEEMED TO BE UNIVERSITY" NEAR DHEBEWADI ROAD, MALKAPUR, TAL-KARAD, DIST: SATARA, MAHARASHTRA, INDIA-415539
INDIAN
12. Names, addresses and nationalities of other persons, if any, authorised to assign or licence of rights comprising the copyright : N.A.
13. If the work is an 'Artistic work', the location of the original work, including name, address and nationality of the person in possession of the work. (In the case of an architectural work, the year of completion of the work should also be shown). : N.A.
14. If the work is an 'Artistic work' which is used or capable of being used in relation to any goods or services, the application should include a certification from the Registrar of Trade Marks in terms of the provision to Sub-Section (i) of Section 45 of the Copyright Act, 1957. : N.A.
15. If the work is an 'Artistic work', whether it is registered under the Copyright Act, 1957, give details. : N.A.
16. If the work is an 'Artistic work', capable of being registered as a trademark under the Trademarks Act 2000, whether it has been applied to an article or service, and if yes, the number of times it has been so applied. : N.A.
17. If the work is a computer program, give details. : N.A.



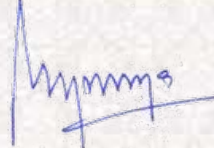

DEPUTY REGISTRAR OF COPYRIGHTS

Diary : 13888/2020-CO/L

Date of Application : 22/09/2020

Date of Receipt : 22/09/2020



Dated : 12/11/2020

1. Registration Number : **L-96698/2020**
2. Name, address and nationality of the applicant : KRISHNA INSTITUTE OF MEDICAL SCIENCES DEEMED TO BE UNIVERSITY, KARAD, MAHARASHTRA. , KRISHNA INSTITUTE OF MEDICAL SCIENCES "DEEMED TO BE UNIVERSITY" NEAR DHEBEWADI ROAD, MALKAPUR, TAL-KARAD, DIST: SATARA, MAHARASHTRA, INDIA-415539
INDIAN
3. Nature of the applicant's interest in the copyright of the work : OWNER
4. Class and description of the work : LITERARY/ DRAMATIC WORK
5. Title of the work : RELEVANCE OF BIOETHICAL PRINCIPLES IN GENETIC ENGINEERING IN BIOTECHNOLOGY
6. Language of the work : ENGLISH
7. Name, address and nationality of the author and if the author is deceased, date of his decease : MRS. SNEHAL ANAND MASURKAR , FACULTY OF ALLIED SCIENCES, MICROBIOLOGY, BIOTECHNOLOGY, KRISHNA INSTITUTE OF MEDICAL SCIENCES "DEEMED TO BE" UNIVERSITY, MALKAPUR, KARAD. MAHARASHTRA-415539
INDIAN
8. Whether the work is published or unpublished : UNPUBLISHED
9. Year and country of first publication and name, address and nationality of the publisher : N.A.
10. Years and countries of subsequent publications, if any, and names, addresses and nationalities of the publishers : N.A.
11. Names, addresses and nationalities of the owners of various rights comprising the copyright in the work and the extent of rights held by each, together with particulars of assignments and licences, if any : KRISHNA INSTITUTE OF MEDICAL SCIENCES DEEMED TO BE UNIVERSITY, KARAD, MAHARASHTRA. , KRISHNA INSTITUTE OF MEDICAL SCIENCES "DEEMED TO BE UNIVERSITY" NEAR DHEBEWADI ROAD, MALKAPUR, TAL-KARAD, DIST: SATARA, MAHARASHTRA, INDIA-415539
INDIAN
12. Names, addresses and nationalities of other persons, if any, authorised to assign or licence of rights comprising the copyright : N.A.
13. If the work is an 'Artistic work', the location of the original work, including name, address and nationality of the person in possession of the work. (In the case of an architectural work, the year of completion of the work should also be shown). : N.A.
14. If the work is an 'Artistic work' which is used or capable of being used in relation to any goods or services, the application should include a certification from the Registrar of Trade Marks in terms of the provision to Sub-Section (i) of Section 45 of the Copyright Act, 1957. : N.A.
15. If the work is an 'Artistic work', whether it is registered under the Designs Act 2000 if yes give details. : N.A.
16. If the work is an 'Artistic work', capable of being registered as a design under the Designs Act 2000. whether it has been applied to an article though an industrial process and ,if yes ,the number of times it is registered. : N.A.
17. F :



13879/2020-CO/L

22/09/2020

22/09/2020

DEPUTY REGISTRAR OF COPYRIGHTS



Dated : 12/11/2020

1. Registration Number : **L-96694/2020**
2. Name, address and nationality of the applicant : KRISHNA INSTITUTE OF MEDICAL SCIENCES DEEMED TO BE UNIVERSITY, KARAD, MAHARASHTRA , KRISHNA INSTITUTE OF MEDICAL SCIENCES "DEEMED TO BE UNIVERSITY" NEAR DHEBEWADI ROAD, MALKAPUR, TAL-KARAD, DIST: SATARA, MAHARASHTRA, INDIA-415539
INDIAN
3. Nature of the applicant's interest in the copyright of the work : OWNER
4. Class and description of the work : LITERARY/ DRAMATIC WORK
5. Title of the work : PARENT TEACHER MEETING IN PROFESSIONAL COLLEGE
6. Language of the work : ENGLISH
7. Name, address and nationality of the author and if the author is deceased, date of his decease : DR VIDYA KADASHETTI , DEPARTMENT OF ORAL PATHOLOGY AND MICROBIOLOGY, SCHOOL OF DENTAL SCIENCES, KRISHNA INSTITUTE OF MEDICAL SCIENCES "DEEMED TO BE UNIVERSITY", KARAD-415539
INDIAN

DR SHASHIKIRAN ND , DEPARTMENT OF ORAL PATHOLOGY AND MICROBIOLOGY, SCHOOL OF DENTAL SCIENCES, KRISHNA INSTITUTE OF MEDICAL SCIENCES "DEEMED TO BE UNIVERSITY", KARAD-415539
INDIAN

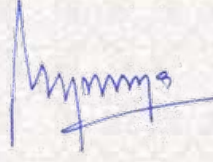
DR SHIVAKUMAR K M , DEPARTMENT OF ORAL PATHOLOGY AND MICROBIOLOGY, SCHOOL OF DENTAL SCIENCES, KRISHNA INSTITUTE OF MEDICAL SCIENCES "DEEMED TO BE UNIVERSITY", KARAD-415539
INDIAN
8. Whether the work is published or unpublished : UNPUBLISHED
9. Year and country of first publication and name, address and nationality of the publisher : N.A.
10. Years and countries of subsequent publications, if any, and names, addresses and nationalities of the publishers : N.A.
11. Names, addresses and nationalities of the owners of various rights comprising the copyright in the work and the extent of rights held by each, together with particulars of assignments and licences, if any : KRISHNA INSTITUTE OF MEDICAL SCIENCES DEEMED TO BE UNIVERSITY, KARAD, MAHARASHTRA , KRISHNA INSTITUTE OF MEDICAL SCIENCES "DEEMED TO BE UNIVERSITY" NEAR DHEBEWADI ROAD, MALKAPUR, TAL-KARAD, DIST: SATARA, MAHARASHTRA, INDIA-415539
INDIAN
12. Names, addresses and nationalities of other persons, if any, authorised to assign or licence of rights comprising the copyright : N.A.
13. If the work is an 'Artistic work', the location of the original work, including name, address and nationality of the person in possession of the work. (In the case of an architectural work, the year of completion of the work should also be shown). : N.A.
14. If the work is an 'Artistic work' which is used or capable of being used in relation to any goods or services, the application should include a certification from the Registrar of Trade Marks in terms of the provisions of Sub-Section (i) of Section 45 of the Copyright Act, 1957. : N.A.
15. If the work is an 'Artistic work', whether it is registered under the provisions of the Copyright Act, 1957, give details. : N.A.
16. If the work is an 'Artistic work', capable of being registered as a trademark under the provisions of the Trademarks Act 2000, whether it has been applied to an article, or to a process, or to a material, or to a substance, or to a service, or to a process and, if yes, the number of times it has been so registered. : N.A.
17. Remarks : 

DEPUTY REGISTRAR OF COPYRIGHTS

Diary Number : 13896/2020-CO/L
Date of Application : 22/09/2020
Date of Receipt : 22/09/2020



Dated : 19/11/2020

1. Registration Number : **L-96809/2020**
2. Name, address and nationality of the applicant : KRISHNA INSTITUTE OF MEDICAL SCIENCES "DEEMED TO BE UNIVERSITY", KARAD , KRISHNA INSTITUTE OF MEDICAL SCIENCES "DEEMED TO BE UNIVERSITY", KARAD, MALKAPUR, KARAD, DIST. SATARA, MAHARASHTRA, INDIA-415539
INDIAN
3. Nature of the applicant's interest in the copyright of the work : OWNER
4. Class and description of the work : LITERARY/ DRAMATIC WORK
5. Title of the work : FEEDBACK OF STUDENTS ABOUT ONLINE SEMINAR ON TOPIC DETERMINATION OF AGE DURING COVID-19 PANDEMIC
6. Language of the work : ENGLISH
7. Name, address and nationality of the author and if the author is deceased, date of his decease : DR. CHANDRAKANT M KOKATANUR , KRISHNA INSTITUTE OF MEDICAL SCIENCES "DEEMED TO BE UNIVERSITY", KARAD, MALKAPUR, KARAD, DIST. SATARA, MAHARASHTRA, INDIA-415539
INDIAN

DR. AJAY VINAYAK PATIL , KRISHNA INSTITUTE OF MEDICAL SCIENCES "DEEMED TO BE UNIVERSITY", KARAD, MALKAPUR, KARAD, DIST. SATARA, MAHARASHTRA, INDIA-415539
INDIAN

DR. VINAY BANNUR , KRISHNA INSTITUTE OF MEDICAL SCIENCES "DEEMED TO BE UNIVERSITY", KARAD, MALKAPUR, KARAD, DIST. SATARA, MAHARASHTRA, INDIA-415539
INDIAN
8. Whether the work is published or unpublished : UNPUBLISHED
9. Year and country of first publication and name, address and nationality of the publisher : N.A.
10. Years and countries of subsequent publications, if any, and names, addresses and nationalities of the publishers : N.A.
11. Names, addresses and nationalities of the owners of various rights comprising the copyright in the work and the extent of rights held by each, together with particulars of assignments and licences, if any : KRISHNA INSTITUTE OF MEDICAL SCIENCES "DEEMED TO BE UNIVERSITY", KARAD , KRISHNA INSTITUTE OF MEDICAL SCIENCES "DEEMED TO BE UNIVERSITY", KARAD, MALKAPUR, KARAD, DIST. SATARA, MAHARASHTRA, INDIA-415539
INDIAN
12. Names, addresses and nationalities of other persons, if any, authorised to assign or licence of rights comprising the copyright : N.A.
13. If the work is an 'Artistic work', the location of the original work, including name, address and nationality of the person in possession of the work. (In the case of an architectural work, the year of completion of the work should also be shown). : N.A.
14. If the work is an 'Artistic work' which is used or capable of being used in relation to any goods or services, the application should include a certification from the Registrar of Trade Marks in terms of the provisions of Sub-Section (i) of Section 45 of the Copyright Act, 1957 : N.A.
15. If the work is an 'Artistic work', whether it is registered under the provisions of the Copyright Act, 1957, give details. : N.A.
16. If the work is an 'Artistic work', capable of being registered as a trademark under the provisions of the Trademarks Act 2000, whether it has been applied to an article, or is in the process of being so applied, if yes, the number of times it has been so applied : N.A.
17. Remarks :

Diary Number : 15531/2020-CO/L
Date of Application : 10/10/2020
Date of Receipt : 10/10/2020

DEPUTY REGISTRAR OF COPYRIGHTS



Dated : 19/11/2020

1. Registration Number : **L-96806/2020**
2. Name, address and nationality of the applicant : KRISHNA INSTITUTE OF MEDICAL SCIENCES DEEMED TO BE UNIVERSITY, KARAD, MAHARASHTRA , KRISHNA INSTITUTE OF MEDICAL SCIENCES "DEEMED TO BE UNIVERSITY" NEAR DHEBEWADI ROAD, MALKAPUR, TAL-KARAD, DIST: SATARA, MAHARASHTRA, INDIA-415539
INDIAN
3. Nature of the applicant's interest in the copyright of the work : OWNER
4. Class and description of the work : LITERARY/ DRAMATIC WORK
5. Title of the work : SELF HELP STRATEGIES FOR RURAL INDIAN POPULATION WITH OSTEOARTHRITIS DURING COVID 19 PANDEMIC
6. Language of the work : ENGLISH
7. Name, address and nationality of the author and if the author is deceased, date of his decease : DR.SANDEEP BABASAHEB SHINDE , ASSOCIATE PROFESSOR ; DEPARTMENT OF MUSCULOSKELETAL SCIENCES ; KRISHNA COLLEGE OF PHYSIOTHERAPY, KARAD; KRISHNA INSTITUTE OF MEDICAL SCIENCES DEEMED TO BE UNIVERSITY, KARAD, MAHARASHTRA, INDIA.-415539
INDIAN

DR. G. VARADHARAJULU , DEAN, KRISHNA COLLEGE OF PHYSIOTHERAPY, KRISHNA INSTITUTE OF MEDICAL SCIENCES "DEEMED TO BE" UNIVERSITY, KARAD-415539
INDIAN
8. Whether the work is published or unpublished : UNPUBLISHED
9. Year and country of first publication and name, address and nationality of the publisher : N.A.
10. Years and countries of subsequent publications, if any, and names, addresses and nationalities of the publishers : N.A.
11. Names, addresses and nationalities of the owners of various rights comprising the copyright in the work and the extent of rights held by each, together with particulars of assignments and licences, if any : KRISHNA INSTITUTE OF MEDICAL SCIENCES DEEMED TO BE UNIVERSITY, KARAD, MAHARASHTRA , KRISHNA INSTITUTE OF MEDICAL SCIENCES "DEEMED TO BE UNIVERSITY" NEAR DHEBEWADI ROAD, MALKAPUR, TAL-KARAD, DIST: SATARA, MAHARASHTRA, INDIA-415539
INDIAN
12. Names, addresses and nationalities of other persons, if any, authorised to assign or licence of rights comprising the copyright : N.A.
13. If the work is an 'Artistic work', the location of the original work, including name, address and nationality of the person in possession of the work. (In the case of an architectural work, the year of completion of the work should also be shown). : N.A.
14. If the work is an 'Artistic work' which is used or capable of being used in relation to any goods or services, the application should include a certification from the Registrar of Trade Marks in terms of the provision to Sub-Section (i) of Section 45 of the Copyright Act, 1957. : N.A.
15. If the work is an 'Artistic work', whether it is registered under the Designs Act 2000 if yes give details. : N.A.
16. If the work is an 'Artistic work', capable of being registered as a design under the Designs Act 2000, whether it has been applied to an article, the date of application, the date of registration, if any, and the number of times it has been applied to an article. : N.A.
17. :



Registration Number : 15538/2020-CO/L
Date of Application : 10/10/2020
Date of Receipt : 10/10/2020



DEPUTY REGISTRAR OF COPYRIGHTS



Dated : 19/10/2020

1. Registration Number : **L-95844/2020**
2. Name, address and nationality of the applicant : KRISHNA INSTITUTE OF MEDICAL SCIENCES "DEEMED TO BE UNIVERSITY," KARAD , KRISHNA INSTITUTE OF MEDICAL SCIENCES "DEEMED TO BE UNIVERSITY" NEAR DHEBEWADI ROAD, MALKAPUR, TAL-KARAD, DIST: SATARA, MAHARASHTRA, INDIA,-415539 INDIAN
3. Nature of the applicant's interest in the copyright of the work : OWNER
4. Class and description of the work : LITERARY/ DRAMATIC WORK DIGITAL NEXUS ONLINE NATIONAL CONFERENCE CONCEPT TO MOTIVATE STUDENTS AND PRESENT THEIR SKILLS ON NATIONAL PLATFORM WITHIN THE GUIDELINES OF PANDEMIC
5. Title of the work : DIGITAL NEXUS- ONLINE NATIONAL CONFERENCE CONCEPT TO MOTIVATE STUDENTS AND PRESENT THEIR SKILLS ON NATIONAL PLATFORM WITHIN THE GUIDELINES OF PANDEMIC
6. Language of the work : ENGLISH
7. Name, address and nationality of the author and if the author is deceased, date of his decease : DR SHASHIKIRAN ND , DEAN, SCHOOL OF DENTAL SCIENCES, KRISHNA INSTITUTE OF MEDICAL SCIENCES "DEEMED TO BE UNIVERSITY" KARAD, MAHARASHTRA-415539 INDIAN
DR ABHIJEET SANDE , ASSISTANT PROFESSOR, DEPARTMENT OF ORAL MEDICINE DIAGNOSIS AND RADIOLOGY, SCHOOL OF DENTAL SCIENCES, KRISHNA INSTITUTE OF MEDICAL SCIENCES "DEEMED TO BE UNIVERSITY" KARAD, MAHARASHTRA-415539 INDIAN
DR. AMIT JADHAV , ASSISTANT PROFESSOR, DEPARTMENT OF PROSTHODONTICS CROWN AND BRIDGE , SCHOOL OF DENTAL SCIENCES, KRISHNA INSTITUTE OF MEDICAL SCIENCES "DEEMED TO BE UNIVERSITY" KARAD, MAHARASHTRA-415539 INDIAN
DR. PANKAJ PATIL , ASSISTANT PROFESSOR, DEPARTMENT OF ORAL AND MAXILLOFACIAL SURGERY , SCHOOL OF DENTAL SCIENCES, KRISHNA INSTITUTE OF MEDICAL SCIENCES "DEEMED TO BE UNIVERSITY" KARAD, MAHARASHTRA-415539 INDIAN
8. Whether the work is published or unpublished : UNPUBLISHED
9. Year and country of first publication and name, address and nationality of the publisher : N.A.
10. Years and countries of subsequent publications, if any, and names, addresses and nationalities of the publishers : N.A.
11. Names, addresses and nationalities of the owners of various rights comprising the copyright in the work and the extent of rights held by each owner with particulars of assignments and licences, if any : KRISHNA INSTITUTE OF MEDICAL SCIENCES "DEEMED TO BE UNIVERSITY," KARAD , KRISHNA INSTITUTE OF MEDICAL SCIENCES "DEEMED TO BE UNIVERSITY" NEAR DHEBEWADI ROAD, MALKAPUR, TAL-KARAD, DIST: SATARA, MAHARASHTRA, INDIA,-415539 INDIAN
12. Nationalities of other persons, if any, and the nature of rights comprising the copyright : N.A.
13. In the case of 'artistic work', the location of the original work, the name, address and nationality of the person in possession of the work, and in the case of an architectural work, the year of completion of the work should also be shown). : N.A.
14. If the work is an 'Artistic work' which is used or capable of being used in relation to any goods or services, the application should include a certification from the Registrar of Trade Marks in terms of the provision to Sub-Section (i) of Section 45 of the Copyright Act, 1957. : N.A.



[Signature]
DEPUTY REGISTRAR OF COPYRIGHTS

15. If the work is an 'Artistic work', whether it is registered under the Designs Act 2000 if yes give details. : N.A.
16. If the work is an 'Artistic work', capable of being registered as a design under the Designs Act 2000.whether it has been applied to an article though an industrial process and ,if yes ,the number of times it is reproduced. : N.A.
17. Remarks, if any :
- Diary Number : 11513/2020-CO/L
- Date of Application : 18/08/2020
- Date of Receipt : 18/08/2020



[Handwritten signature]

DEPUTY REGISTRAR OF COPYRIGHTS



Dated : 19/10/2020

1. Registration Number : **L-95843/2020**
2. Name, address and nationality of the applicant : KRISHNA INSTITUTE OF MEDICAL SCIENCES "DEEMED TO BE UNIVERSITY," KARAD , KRISHNA INSTITUTE OF MEDICAL SCIENCES "DEEMED TO BE UNIVERSITY" NEAR DHEBEWADI ROAD, MALKAPUR, TAL-KARAD, DIST: SATARA, MAHARASHTRA, INDIA,-415539 INDIAN
3. Nature of the applicant's interest in the copyright of the work : OWNER
4. Class and description of the work : LITERARY/ DRAMATIC WORK A NOVEL TEACHING TOOL TO MOTIVATE STUDENTS FOR COMPETITIVE SKILLS AND LEARNING METHODOLOGY
5. Title of the work : CASE OF THE MONTH- A NOVEL TEACHING TOOL TO MOTIVATE STUDENTS FOR COMPETITIVE SKILLS AND LEARNING METHODOLOGY
6. Language of the work : ENGLISH
7. Name, address and nationality of the author and if the author is deceased, date of his decease : DR. ABHIJEET SANDE , ASSISTANT PROFESSOR, DEPARTMENT OF ORAL MEDICINE DIAGNOSIS AND RADIOLOGY, SCHOOL OF DENTAL SCIENCES, KRISHNA INSTITUTE OF MEDICAL SCIENCES "DEEMED TO BE UNIVERSITY" KARAD, MAHARASHTRA-415539 INDIAN

DR. AJAY NAYAK , ASSOCIATE PROFESSOR, DEPARTMENT OF ORAL MEDICINE DIAGNOSIS AND RADIOLOGY, SCHOOL OF DENTAL SCIENCES, KRISHNA INSTITUTE OF MEDICAL SCIENCES "DEEMED TO BE UNIVERSITY" KARAD, MAHARASHTRA-415539 INDIAN

DR. ASHWINIRANI SR , ASSISTANT PROFESSOR, DEPARTMENT OF ORAL MEDICINE DIAGNOSIS AND RADIOLOGY, SCHOOL OF DENTAL SCIENCES, KRISHNA INSTITUTE OF MEDICAL SCIENCES "DEEMED TO BE UNIVERSITY" KARAD, MAHARASHTRA-415539 INDIAN

DR SHASHIKIRAN ND , DEAN, SCHOOL OF DENTAL SCIENCES, KRISHNA INSTITUTE OF MEDICAL SCIENCES "DEEMED TO BE UNIVERSITY" KARAD, MAHARASHTRA-415539 INDIAN
8. Whether the work is published or unpublished : UNPUBLISHED
9. Year and country of first publication and name, address and nationality of the publisher : N.A.
10. Years and countries of subsequent publications, if any, and names, addresses and nationalities of the publishers : N.A.
11. Names, addresses and nationalities of the owners of various rights comprising the copyright in the work and the extent of rights held by each, together with particulars of assignments and licences, if any : KRISHNA INSTITUTE OF MEDICAL SCIENCES "DEEMED TO BE UNIVERSITY," KARAD , KRISHNA INSTITUTE OF MEDICAL SCIENCES "DEEMED TO BE UNIVERSITY" NEAR DHEBEWADI ROAD, MALKAPUR, TAL-KARAD, DIST: SATARA, MAHARASHTRA, INDIA,-415539 INDIAN
12. Names, addresses and nationalities of other persons, if any, and the extent of rights comprising the copyright : N.A.
13. If the work is an 'Artistic work', the location of the original work, the name and nationality of the person in possession of the work and if it is an architectural work, the year of completion of the work should also be shown). : N.A.
14. If the work is an 'Artistic work' which is used or capable of being used in relation to any goods or services, the application should include a certification from the Registrar of Trade Marks in terms of the provision to Sub-Section (i) of Section 45 of the Copyright Act, 1957. : N.A.
15. If the work is an 'Artistic work', whether it is registered under the Designs Act 2000 if yes give details. : N.A.



[Handwritten Signature]

DEPUTY REGISTRAR OF COPYRIGHTS

16. If the work is an 'Artistic work', capable of being registered as a design under the Designs Act 2000, whether it has been applied to an article through an industrial process and, if yes, the number of times it is reproduced. : N.A.

17. Remarks, if any :

Diary Number : 11508/2020-CO/L

Date of Application : 18/08/2020

Date of Receipt : 18/08/2020



A handwritten signature in blue ink, written in a cursive style, is positioned above the title of the official.

DEPUTY REGISTRAR OF COPYRIGHTS



Dated : 19/10/2020

1. Registration Number : **L-95847/2020**
2. Name, address and nationality of the applicant : KRISHNA INSTITUTE OF MEDICAL SCIENCES DEEMED TO BE UNIVERSITY, KARAD, MAHARASHTRA , KRISHNA INSTITUTE OF MEDICAL SCIENCES DEEMED TO BE UNIVERSITY, NEAR DHEBEWADI ROAD, MALKAPUR TAL – KARAD. DIST. – SATARA, MAHARASHTRA, INDIA-415539 INDIAN
3. Nature of the applicant's interest in the copyright of the work : OWNER
4. Class and description of the work : LITERARY/ DRAMATIC WORK PHYSIOTHERAPY READINESS SCREENING TOOL PRST FOR ICU BOUND COVID 19 PATIENTS
5. Title of the work : PHYSIOTHERAPY READINESS SCREENING TOOL (PRST) FOR ICU-BOUND COVID-19 PATIENTS
6. Language of the work : ENGLISH
7. Name, address and nationality of the author and if the author is deceased, date of his decease : DR.PRASANNAJEET PRAMOD NIKAM , ASSISTANT PROFESSOR ; KRISHNA COLLEGE OF PHYSIOTHERAPY, KARAD; DEPARTMENT OF SPORTS PHYSIOTHERAPY; KRISHNA INSTITUTE OF MEDICAL SCIENCES DEEMED TO BE UNIVERSITY, KARAD, MAHARASHTRA, INDIA-415539 INDIAN
DR.G.VARADHARAJULU , DEAN; FACULTY OF PHYSIOTHERAPY; KRISHNA COLLEGE OF PHYSIOTHERAPY, KARAD; DEPARTMENT OF NEUROSCIENCES; KRISHNA INSTITUTE OF MEDICAL SCIENCES DEEMED TO BE UNIVERSITY, KARAD, MAHARASHTRA, INDIA.-415539 INDIAN
8. Whether the work is published or unpublished : UNPUBLISHED
9. Year and country of first publication and name, address and nationality of the publisher : N.A.
10. Years and countries of subsequent publications, if any, and names, addresses and nationalities of the publishers : N.A.
11. Names, addresses and nationalities of the owners of various rights comprising the copyright in the work and the extent of rights held by each, together with particulars of assignments and licences, if any : KRISHNA INSTITUTE OF MEDICAL SCIENCES DEEMED TO BE UNIVERSITY, KARAD, MAHARASHTRA , KRISHNA INSTITUTE OF MEDICAL SCIENCES DEEMED TO BE UNIVERSITY, NEAR DHEBEWADI ROAD, MALKAPUR TAL – KARAD. DIST. – SATARA, MAHARASHTRA, INDIA-415539 INDIAN
12. Names, addresses and nationalities of other persons, if any, authorised to assign or licence of rights comprising the copyright : N.A.
13. If the work is an 'Artistic work', the location of the original work, including name, address and nationality of the person in possession of the work. (In the case of an architectural work, the year of completion of the work should also be shown). : N.A.
14. If the work is an 'Artistic work' which is used or capable of being used in relation to any goods or services, the application should include a certification from the Registrar of Trade Marks in terms of the provisions of Sub-Section (i) of Section 45 of the Copyright Act, 1957. : N.A.
15. If the work is an 'Artistic work', whether it is registered under the provisions of the Copyright Act, 1957, give details. : N.A.
16. If the work is an 'Artistic work', capable of being registered as a trademark under the provisions of the Trademarks Act 2000, whether it has been applied to an article, or is in the process of being so applied, if yes, the number of times it has been so applied. : N.A.
17. Remarks :

Diary Number : 11532/2020-CO/L
Date of Application : 18/08/2020
Date of Receipt : 18/08/2020

DEPUTY REGISTRAR OF COPYRIGHTS



Dated : 05/11/2020

1. Registration Number : **L-96501/2020**
2. Name, address and nationality of the applicant : KRISHNA INSTITUTE OF MEDICAL SCIENCES "DEEMED TO BE UNIVERSITY", KARAD , NH4, PUNE - BANGALORE HIGHWAY, DIST.SATARA, AGASHIVNAGAR, MALKAPUR, MAHARASHTRA-415539 INDIAN
3. Nature of the applicant's interest in the copyright of the work : OWNER
4. Class and description of the work : LITERARY/ DRAMATIC WORK
5. Title of the work : "PERIOCHITRA"- CONCEPT TO SAVE PATIENTS CHAIR SIDE TIME DURING PERIODONTAL CASE HISTORY DISCUSSION OF UNDERGRADUATE STUDENTS
6. Language of the work : ENGLISH
7. Name, address and nationality of the author and if the author is deceased, date of his decease : DR. A. SIDDHARTHA VARMA , DEPARTMENT OF PERIODONTOLOGY, SCHOOL OF DENTAL SCIENCES, KRISHNA INSTITUTE OF MEDICAL SCIENCES "DEEMED TO BE UNIVERSITY", NH4, PUNE - BANGALORE HIGHWAY, DIST.SATARA, AGASHIVNAGAR, MALKAPUR, MAHARASHTR-415539 INDIAN
DR. GIRISH SURAGIMATH , DEPARTMENT OF PERIODONTOLOGY, SCHOOL OF DENTAL SCIENCES, KRISHNA INSTITUTE OF MEDICAL SCIENCES "DEEMED TO BE UNIVERSITY", NH4, PUNE - BANGALORE HIGHWAY, DIST.SATARA, AGASHIVNAGAR, MALKAPUR, MAHARASHTR-415539 INDIAN
DR. SAMEER ZOPE , DEPARTMENT OF PERIODONTOLOGY, SCHOOL OF DENTAL SCIENCES, KRISHNA INSTITUTE OF MEDICAL SCIENCES "DEEMED TO BE UNIVERSITY", NH4, PUNE - BANGALORE HIGHWAY, DIST.SATARA, AGASHIVNAGAR, MALKAPUR, MAHARASHTR-415539 INDIAN
8. Whether the work is published or unpublished : UNPUBLISHED
9. Year and country of first publication and name, address and nationality of the publisher : N.A.
10. Years and countries of subsequent publications, if any, and names, addresses and nationalities of the publishers : N.A.
11. Names, addresses and nationalities of the owners of various rights comprising the copyright in the work and the extent of rights held by each, together with particulars of assignments and licences, if any : KRISHNA INSTITUTE OF MEDICAL SCIENCES "DEEMED TO BE UNIVERSITY", KARAD , NH4, PUNE - BANGALORE HIGHWAY, DIST.SATARA, AGASHIVNAGAR, MALKAPUR, MAHARASHTRA-415539 INDIAN
12. Names, addresses and nationalities of other persons, if any, authorised to assign or licence of rights comprising the copyright : KRISHNA INSTITUTE OF MEDICAL SCIENCES "DEEMED TO BE UNIVERSITY", KARAD , NH4, PUNE - BANGALORE HIGHWAY, DIST.SATARA, AGASHIVNAGAR, MALKAPUR, MAHARASHTRA-415539 INDIAN
13. If the work is an 'Artistic work', the location of the original work, the name and nationality of the person in possession of an architectural work, the year of construction (if any) should also be shown). : N.A.
14. If the work is a 'Design' which is used or capable of being used in goods or services, the application should be made to the Registrar of Trade Marks in terms of the provisions of Section (i) of Section 45 of the Copyright Act, 1957. : N.A.
15. If the work is an 'Artistic work', whether it is registered under the Designs Act 2000 if yes give details. : N.A.
16. If the work is an 'Artistic work', capable of being registered as a design under the Designs Act 2000.whether it has been applied to an article though an industrial process and ,if yes ,the number of times it is reproduced. : N.A.



DEPUTY REGISTRAR OF COPYRIGHTS

17. Remarks, if any :

Diary Number :

11883/2020-CO/L

Date of Application :

24/08/2020

Date of Receipt :

24/08/2020



A handwritten signature in blue ink, appearing to read "M. M. M. S.", is written over a faint rectangular stamp.

DEPUTY REGISTRAR OF COPYRIGHTS



Dated : 05/11/2020

1. Registration Number : **L-96502/2020**
2. Name, address and nationality of the applicant : KRISHNA INSTITUTE OF MEDICAL SCIENCES "DEEMED TO BE UNIVERSITY", KARAD , NH4, PUNE - BANGALORE HIGHWAY, DIST.SATARA, AGASHIVNAGAR, MALKAPUR, MAHARASHTRA-415539 INDIAN
3. Nature of the applicant's interest in the copyright of the work : OWNER
4. Class and description of the work : LITERARY/ DRAMATIC WORK
5. Title of the work : STUDENTS LEARNING BY PERFORMING (UNDER FACULTY SUPERVISION) DEMONSTRATION OF MECHANICAL INJURIES (STAB, INCISION AND LACERATION) ON A BANANA LEAF
6. Language of the work : ENGLISH
7. Name, address and nationality of the author and if the author is deceased, date of his decease : DR. VINAY BANNUR , NH4, PUNE - BANGALORE HIGHWAY, DIST.SATARA, AGASHIVNAGAR, MALKAPUR, MAHARASHTRA-415539 INDIAN
8. Whether the work is published or unpublished : UNPUBLISHED
9. Year and country of first publication and name, address and nationality of the publisher : N.A.
10. Years and countries of subsequent publications, if any, and names, addresses and nationalities of the publishers : N.A.
11. Names, addresses and nationalities of the owners of various rights comprising the copyright in the work and the extent of rights held by each, together with particulars of assignments and licences, if any : KRISHNA INSTITUTE OF MEDICAL SCIENCES "DEEMED TO BE UNIVERSITY", KARAD , NH4, PUNE - BANGALORE HIGHWAY, DIST.SATARA, AGASHIVNAGAR, MALKAPUR, MAHARASHTRA-415539 INDIAN
12. Names, addresses and nationalities of other persons, if any, authorised to assign or licence of rights comprising the copyright : KRISHNA INSTITUTE OF MEDICAL SCIENCES "DEEMED TO BE UNIVERSITY", KARAD , NH4, PUNE - BANGALORE HIGHWAY, DIST.SATARA, AGASHIVNAGAR, MALKAPUR, MAHARASHTRA-415539 INDIAN
13. If the work is an 'Artistic work', the location of the original work, including name, address and nationality of the person in possession of the work. (In the case of an architectural work, the year of completion of the work should also be shown). : N.A.
14. If the work is an 'Artistic work' which is used or capable of being used in relation to any goods or services, the application should include a certification from the Registrar of Trade Marks in terms of the provision to Sub-Section (i) of Section 45 of the Copyright Act, 1957. : N.A.
15. If the work is an 'Artistic work', whether it is registered under the Designs Act 2000 if yes give details. : N.A.
16. If the work is an 'Artistic work', capable of being registered as a design under the Designs Act 2000, whether it has been applied to an article, or to an industrial process and ,if yes ,the number of times it is : N.A.
17. :



11886/2020-CO/L
24/08/2020
24/08/2020

DEPUTY REGISTRAR OF COPYRIGHTS



Dated : 05/11/2020

1. Registration Number : **L-96503/2020**
2. Name, address and nationality of the applicant : KRISHNA INSTITUTE OF MEDICAL SCIENCES "DEEMED TO BE UNIVERSITY", KARAD , NH4, PUNE - BANGALORE HIGHWAY, DIST.SATARA, AGASHIVNAGAR, MALKAPUR, MAHARASHTRA-415539 INDIAN
3. Nature of the applicant's interest in the copyright of the work : OWNER
4. Class and description of the work : LITERARY/ DRAMATIC WORK
5. Title of the work : DEMONSTRATION OF MECHANICAL INJURIES (STAB, INCISION AND LACERATION) ON BANANA LEAF
6. Language of the work : ENGLISH
7. Name, address and nationality of the author and if the author is deceased, date of his decease : DR. VINAY BANNUR , NH4, PUNE - BANGALORE HIGHWAY, DIST.SATARA, AGASHIVNAGAR, MALKAPUR, MAHARASHTRA-415539 INDIAN
8. Whether the work is published or unpublished : UNPUBLISHED
9. Year and country of first publication and name, address and nationality of the publisher : N.A.
10. Years and countries of subsequent publications, if any, and names, addresses and nationalities of the publishers : N.A.
11. Names, addresses and nationalities of the owners of various rights comprising the copyright in the work and the extent of rights held by each, together with particulars of assignments and licences, if any : KRISHNA INSTITUTE OF MEDICAL SCIENCES "DEEMED TO BE UNIVERSITY", KARAD , NH4, PUNE - BANGALORE HIGHWAY, DIST.SATARA, AGASHIVNAGAR, MALKAPUR, MAHARASHTRA-415539 INDIAN
12. Names, addresses and nationalities of other persons, if any, authorised to assign or licence of rights comprising the copyright : KRISHNA INSTITUTE OF MEDICAL SCIENCES "DEEMED TO BE UNIVERSITY", KARAD , NH4, PUNE - BANGALORE HIGHWAY, DIST.SATARA, AGASHIVNAGAR, MALKAPUR, MAHARASHTRA-415539 INDIAN
13. If the work is an 'Artistic work', the location of the original work, including name, address and nationality of the person in possession of the work. (In the case of an architectural work, the year of completion of the work should also be shown). : N.A.
14. If the work is an 'Artistic work' which is used or capable of being used in relation to any goods or services, the application should include a certification from the Registrar of Trade Marks in terms of the provision to Sub-Section (i) of Section 45 of the Copyright Act, 1957. : N.A.
15. If the work is an 'Artistic work', whether it is registered under the Designs Act 2000 if yes give details. : N.A.
16. If the work is an 'Artistic work', capable of being registered as a design under the Designs Act 2000.whether it has been applied to an article though an industrial process and ,if yes ,the number of times it is reproduced. : N.A.
17. Re : :



11888/2020-CO/L
24/08/2020
24/08/2020

DEPUTY REGISTRAR OF COPYRIGHTS



Dated : 05/11/2020

1. Registration Number : **L-96499/2020**
2. Name, address and nationality of the applicant : KRISHNA INSTITUTE OF MEDICAL SCIENCES "DEEMED TO BE UNIVERSITY", KARAD , NH4, PUNE - BANGALORE HIGHWAY, DIST.SATARA, AGASHIVNAGAR, MALKAPUR, MAHARASHTRA-415539 INDIAN
3. Nature of the applicant's interest in the copyright of the work : OWNER
4. Class and description of the work : LITERARY/ DRAMATIC WORK
5. Title of the work : ONLINE SEMINAR USING TELEVISION & ANDROID MOBILE PHONE ON TOPIC: DETERMINATION OF AGE FROM DENTAL FINDINGS (IN LATER AGES)
6. Language of the work : ENGLISH
7. Name, address and nationality of the author and if the author is deceased, date of his decease : DR. AJAY VINAYAK PATIL , KRISHNA INSTITUTE OF MEDICAL SCIENCES "DEEMED TO BE UNIVERSITY", KARAD, NH4, PUNE - BANGALORE HIGHWAY, DIST.SATARA, AGASHIVNAGAR, MALKAPUR, MAHARASHTRA-415539 INDIAN
DR. CHANDRAKANT M KOKATANUR , KRISHNA INSTITUTE OF MEDICAL SCIENCES "DEEMED TO BE UNIVERSITY", KARAD, NH4, PUNE - BANGALORE HIGHWAY, DIST.SATARA, AGASHIVNAGAR, MALKAPUR, MAHARASHTRA-415539 INDIAN
DR. VINAY BANNUR , KRISHNA INSTITUTE OF MEDICAL SCIENCES "DEEMED TO BE UNIVERSITY", KARAD, NH4, PUNE - BANGALORE HIGHWAY, DIST.SATARA, AGASHIVNAGAR, MALKAPUR, MAHARASHTRA-415539 INDIAN
TANAYA KULKARNI , KRISHNA INSTITUTE OF MEDICAL SCIENCES "DEEMED TO BE UNIVERSITY", KARAD, NH4, PUNE - BANGALORE HIGHWAY, DIST.SATARA, AGASHIVNAGAR, MALKAPUR, MAHARASHTRA-415539 INDIAN
8. Whether the work is published or unpublished : UNPUBLISHED
9. Year and country of first publication and name, address and nationality of the publisher : N.A.
10. Years and countries of subsequent publications, if any, and names, addresses and nationalities of the publishers : N.A.
11. Names, addresses and nationalities of the owners of various rights comprising the copyright in the work and the extent of rights held by each, together with particulars of assignments and licences, if any : KRISHNA INSTITUTE OF MEDICAL SCIENCES "DEEMED TO BE UNIVERSITY", KARAD , NH4, PUNE - BANGALORE HIGHWAY, DIST.SATARA, AGASHIVNAGAR, MALKAPUR, MAHARASHTRA-415539 INDIAN
12. Names, addresses and nationalities of other persons, if any, authorised to assign or licence of rights comprising the copyright : KRISHNA INSTITUTE OF MEDICAL SCIENCES "DEEMED TO BE UNIVERSITY", KARAD , NH4, PUNE - BANGALORE HIGHWAY, DIST.SATARA, AGASHIVNAGAR, MALKAPUR, MAHARASHTRA-415539 INDIAN
13. If the work is an 'Artistic work', the location of the original work, and nationality of the person in possession of an architectural work, the year of (should also be shown). : N.A. 
14. If the work is an 'Artistic work' which is used or capable of being used in connection with any goods or services, the application should include a certification from the Registrar of Trade Marks in terms of the provision to Sub-Section (i) of Section 45 of the Copyright Act, 1957. : N.A. **DEPUTY REGISTRAR OF COPYRIGHTS**
15. If the work is an 'Artistic work', whether it is registered under the Designs Act 2000 if yes give details. : N.A.



16. If the work is an 'Artistic work', capable of being registered as a design under the Designs Act 2000, whether it has been applied to an article through an industrial process and, if yes, the number of times it is reproduced. : N.A.

17. Remarks, if any :

Diary Number : 11860/2020-CO/L

Date of Application : 24/08/2020

Date of Receipt : 24/08/2020



A handwritten signature in blue ink, appearing to read 'M. M. M. S.', is written over a faint rectangular stamp.

DEPUTY REGISTRAR OF COPYRIGHTS



Dated : 05/11/2020

1. Registration Number : **L-96500/2020**
2. Name, address and nationality of the applicant : KRISHNA INSTITUTE OF MEDICAL SCIENCES "DEEMED TO BE UNIVERSITY", KARAD , NH4, PUNE - BANGALORE HIGHWAY, DIST.SATARA, AGASHIVNAGAR, MALKAPUR, MAHARASHTRA-415539 INDIAN
3. Nature of the applicant's interest in the copyright of the work : OWNER
4. Class and description of the work : LITERARY/ DRAMATIC WORK
5. Title of the work : ONLINE SEMINAR WITH HELP OF AUDIO VIDEO PRESENTATION USING MOBILE ON TOPIC GENERAL AND SECONDARY SEXUAL CHARACTERS IN DETERMINATION OF AGE
6. Language of the work : ENGLISH
7. Name, address and nationality of the author and if the author is deceased, date of his decease : DR. AJAY PATIL , NH4, PUNE - BANGALORE HIGHWAY, DIST.SATARA, AGASHIVNAGAR, MALKAPUR, MAHARASHTRA-415539 INDIAN
DR.CHANDRAKANT M KOKATANUR , NH4, PUNE - BANGALORE HIGHWAY, DIST.SATARA, AGASHIVNAGAR, MALKAPUR, MAHARASHTRA-415539 INDIAN
DR. VINAY BANNUR , NH4, PUNE - BANGALORE HIGHWAY, DIST.SATARA, AGASHIVNAGAR, MALKAPUR, MAHARASHTRA-415539 INDIAN
SNEHAM GILANI , NH4, PUNE - BANGALORE HIGHWAY, DIST.SATARA, AGASHIVNAGAR, MALKAPUR, MAHARASHTRA-415539 INDIAN
8. Whether the work is published or unpublished : UNPUBLISHED
9. Year and country of first publication and name, address and nationality of the publisher : N.A.
10. Years and countries of subsequent publications, if any, and names, addresses and nationalities of the publishers : N.A.
11. Names, addresses and nationalities of the owners of various rights comprising the copyright in the work and the extent of rights held by each, together with particulars of assignments and licences, if any : KRISHNA INSTITUTE OF MEDICAL SCIENCES "DEEMED TO BE UNIVERSITY", KARAD , NH4, PUNE - BANGALORE HIGHWAY, DIST.SATARA, AGASHIVNAGAR, MALKAPUR, MAHARASHTRA-415539 INDIAN
12. Names, addresses and nationalities of other persons, if any, authorised to assign or licence of rights comprising the copyright : KRISHNA INSTITUTE OF MEDICAL SCIENCES "DEEMED TO BE UNIVERSITY", KARAD , NH4, PUNE - BANGALORE HIGHWAY, DIST.SATARA, AGASHIVNAGAR, MALKAPUR, MAHARASHTRA-415539 INDIAN
13. If the work is an 'Artistic work', the location of the original work, including the address and nationality of the person in possession of the work (in the case of an architectural work, the year of construction of the work should also be shown). : N.A.
14. If the work is a 'work' which is used or capable of being used in goods or services, the application should be made to the Registrar of Trade Marks in terms of section (i) of Section 45 of the Copyright Act, : N.A.
15. If the work is an 'Artistic work', whether it is registered under the Designs Act 2000 if yes give details. : N.A. 
16. If the work is an 'Artistic work', capable of being registered as a design under the Designs Act 2000, whether it has been applied to an article though an industrial process and, if yes, the number of times it is reproduced. : N.A.
17. Remarks, if any :

DEPUTY REGISTRAR OF COPYRIGHTS



Diary Number : 11862/2020-CO/L
Date of Application : 24/08/2020
Date of Receipt : 24/08/2020



A handwritten signature in blue ink, appearing to read "M. M. M. S.", is written over a faint rectangular stamp.

DEPUTY REGISTRAR OF COPYRIGHTS



Dated : 27/11/2020

1. Registration Number : **L-96988/2020**
2. Name, address and nationality of the applicant : KRISHNA INSTITUTE OF MEDICALSCIENCES“DEEMED TO BE UNIVERSITY , NH4,PUNE -BANGALORE HIGHWAY, DIST. SATARA, AGASHIVNAGAR, MALKAPUR, MAHARASHTRA-415539
INDIAN
3. Nature of the applicant's interest in the copyright of the work : OWNER
4. Class and description of the work : LITERARY/ DRAMATIC WORK
5. Title of the work : AN INNOVATIVE APPROACH FOR SAFETY CONCERNS DURING MRI-MR PRO (A MAGNETIC RESONANCE PROTECTIVE SPLINT)
6. Language of the work : ENGLISH
7. Name, address and nationality of the author and if the author is deceased, date of his decease : DR. RITIKA BHAMBANI , DEPARTMENT OF PROSTHODONTICS AND CROWN & BRIDGE, GURUNANAK INSTITUTE OF DENTAL SCIENCES AND RESEARCH, KOLKATA-700114
INDIAN

DR. SHUBHA JOSHI , KRISHNA INSTITUTE OF MEDICAL SCIENCES “DEEMED TO BE UNIVERSITY”, MALKAPUR, KARAD-415539
INDIAN

DR. SHANTANU SEN ROY , DEPARTMENT OF PUBLIC HEALTH, GURUNANAK INSTITUTE OF DENTAL SCIENCES AND RESEARCH, KOLKATA-700114
INDIAN
8. Whether the work is published or unpublished : UNPUBLISHED
9. Year and country of first publication and name, address and nationality of the publisher : N.A.
10. Years and countries of subsequent publications, if any, and names, addresses and nationalities of the publishers : N.A.
11. Names, addresses and nationalities of the owners of various rights comprising the copyright in the work and the extent of rights held by each, together with particulars of assignments and licences, if any : KRISHNA INSTITUTE OF MEDICALSCIENCES“DEEMED TO BE UNIVERSITY , NH4,PUNE -BANGALORE HIGHWAY, DIST. SATARA, AGASHIVNAGAR, MALKAPUR, MAHARASHTRA-415539
INDIAN
12. Names, addresses and nationalities of other persons, if any, authorised to assign or licence of rights comprising the copyright : KRISHNA INSTITUTE OF MEDICALSCIENCES“DEEMED TO BE UNIVERSITY , NH4,PUNE -BANGALORE HIGHWAY, DIST. SATARA, AGASHIVNAGAR, MALKAPUR, MAHARASHTRA-415539
INDIAN
13. If the work is an 'Artistic work', the location of the original work, including name, address and nationality of the person in possession of the work. (In the case of an architectural work, the year of completion of the work should also be shown). : N.A.
14. If the work is an 'Artistic work' which is used or capable of being used in relation to any goods or services, the application should include a certification from the Registrar of Trade Marks in terms of the provisions of Sub-Section (i) of Section 45 of the Copyright Act, 1957. : N.A.
15. If the work is an 'Artistic work', whether it is registered under the provisions of the Trade Marks Act, 1999, give details. : N.A.
16. If the work is an 'Artistic work', capable of being registered as a trademark under the Trade Marks Act 2000, whether it has been applied to an article in the industrial process and, if yes, the number of times it has been so applied. : N.A.
17. Remarks :

Diary Number : 15783/2020-CO/L
Date of Application : 14/10/2020
Date of Receipt : 14/10/2020

DEPUTY REGISTRAR OF COPYRIGHTS



Dated : 25/11/2020

1. Registration Number : **L-96902/2020**
2. Name, address and nationality of the applicant : KRISHNA INSTITUTE OF MEDICAL SCIENCES "DEEMED TO BE UNIVERSITY" KARAD , NEAR DHEBEWADI ROAD, PUNE BANGLORE NH NO.4, MALKAPUR, KARAD 415339-415339 INDIAN
3. Nature of the applicant's interest in the copyright of the work : OWNER
4. Class and description of the work : LITERARY/ DRAMATIC WORK
5. Title of the work : TOOL ON COPING MECHANISUM OF PARTURIENT MOTHERS
6. Language of the work : ENGLISH
7. Name, address and nationality of the author and if the author is deceased, date of his decease : MISS. VISHNUPRYA P , A/P MALKAPUR , TAL. KARAD, DIST.SATARA-415339 INDIAN
DR. JYOTI A. SALUNKHE , A/P MALKAPUR , TAL. KARAD, DIST.SATARA-415339 INDIAN
DR.AVINASH H. SALUNKHE , A/P MALKAPUR , TAL. KARAD, DIST.SATARA-415339 INDIAN
8. Whether the work is published or unpublished : UNPUBLISHED
9. Year and country of first publication and name, address and nationality of the publisher : N.A.
10. Years and countries of subsequent publications, if any, and names, addresses and nationalities of the publishers : N.A.
11. Names, addresses and nationalities of the owners of various rights comprising the copyright in the work and the extent of rights held by each, together with particulars of assignments and licences, if any : KRISHNA INSTITUTE OF MEDICAL SCIENCES "DEEMED TO BE UNIVERSITY" KARAD , NEAR DHEBEWADI ROAD, PUNE BANGLORE NH NO.4, MALKAPUR, KARAD 415339-415339 INDIAN
12. Names, addresses and nationalities of other persons, if any, authorised to assign or licence of rights comprising the copyright : N.A.
13. If the work is an 'Artistic work', the location of the original work, including name, address and nationality of the person in possession of the work. (In the case of an architectural work, the year of completion of the work should also be shown). : N.A.
14. If the work is an 'Artistic work' which is used or capable of being used in relation to any goods or services, the application should include a certification from the Registrar of Trade Marks in terms of the provision to Sub-Section (i) of Section 45 of the Copyright Act, 1957. : N.A.
15. If the work is an 'Artistic work', whether it is registered under the Designs Act 2000 if yes give details. : N.A.
16. If the work is an 'Artistic work', capable of being registered as a design under the Designs Act 2000.whether it has been applied to an article though an industrial process and ,if yes ,the number of times it is registered. : N.A.
17. F :



16724/2020-CO/L
24/10/2020
24/10/2020



DEPUTY REGISTRAR OF COPYRIGHTS



Dated : 18/11/2020

1. Registration Number : **L-96755/2020**
2. Name, address and nationality of the applicant : KRISHNA INSTITUTE OF MEDICAL SCIENCES DEEMED TO BE UNIVERSITY, KARAD, MAHARASHTRA , KRISHNA INSTITUTE OF MEDICAL SCIENCES "DEEMED TO BE UNIVERSITY" NEAR DHEBEWADI ROAD, MALKAPUR, TAL-KARAD, DIST: SATARA, MAHARASHTRA, INDIA,- 415539
INDIAN
3. Nature of the applicant's interest in the copyright of the work : OWNER
4. Class and description of the work : LITERARY/ DRAMATIC WORK POEM
5. Title of the work : O HINDUSTANI THODA SHAYM RAKHLE
6. Language of the work : HINDI
7. Name, address and nationality of the author and if the author is deceased, date of his decease : MR. KARTIKESH RAMESH GAVALI , DEPARTMENT OF SCHOOL OF DENTAL SCIENCES, KRISHNA INSTITUTE OF MEDICAL SCIENCES "DEEMED TO BE UNIVERSITY", KARAD-415539
INDIAN

DR. SHASHIKIRAN N D , DEPARTMENT OF SCHOOL OF DENTAL SCIENCES, KRISHNA INSTITUTE OF MEDICAL SCIENCES "DEEMED TO BE UNIVERSITY", KARAD-415539
INDIAN

DR. ASHWINIRANI S R , DEPARTMENT OF SCHOOL OF DENTAL SCIENCES, KRISHNA INSTITUTE OF MEDICAL SCIENCES "DEEMED TO BE UNIVERSITY", KARAD-415539
INDIAN
8. Whether the work is published or unpublished : UNPUBLISHED
9. Year and country of first publication and name, address and nationality of the publisher : N.A.
10. Years and countries of subsequent publications, if any, and names, addresses and nationalities of the publishers : N.A.
11. Names, addresses and nationalities of the owners of various rights comprising the copyright in the work and the extent of rights held by each, together with particulars of assignments and licences, if any : KRISHNA INSTITUTE OF MEDICAL SCIENCES DEEMED TO BE UNIVERSITY, KARAD, MAHARASHTRA , KRISHNA INSTITUTE OF MEDICAL SCIENCES "DEEMED TO BE UNIVERSITY" NEAR DHEBEWADI ROAD, MALKAPUR, TAL-KARAD, DIST: SATARA, MAHARASHTRA, INDIA,- 415539
INDIAN
12. Names, addresses and nationalities of other persons, if any, authorised to assign or licence of rights comprising the copyright : N.A.
13. If the work is an 'Artistic work', the location of the original work, including name, address and nationality of the person in possession of the work. (In the case of an architectural work, the year of completion of the work should also be shown). : N.A.
14. If the work is an 'Artistic work' which is used or capable of being used in relation to any goods or services, the application should include a certification from the Registrar of Trade Marks in terms of the provision to Sub-Section (i) of Section 45 of the Copyright Act, 1957. : N.A.
15. If the work is an 'Artistic work', whether it is registered under the Copyright Act, 1957, give details. : N.A.
16. If the work is an 'Artistic work', capable of being registered as a work of art under the Copyright Act 2000, whether it has been applied to an industrial process and, if yes, the number of times : N.A.
17. : N.A.





DEPUTY REGISTRAR OF COPYRIGHTS

Diary : 15523/2020-CO/L

Date of Application : 10/10/2020

Date of Receipt : 10/10/2020



Dated : 26/11/2020

1. Registration Number : **L-96947/2020**
2. Name, address and nationality of the applicant : KRISHNA INSTITUTE OF MEDICAL SCIENCES "DEEMED TO BE UNIVERSITY", KARAD , KRISHNA INSTITUTE OF MEDICAL SCIENCES "DEEMED TO BE UNIVERSITY", KARAD, MALKAPUR, KARAD, DIST. SATARA, MAHARASHTRA, INDIA-415539 INDIAN
3. Nature of the applicant's interest in the copyright of the work : OWNER
4. Class and description of the work : LITERARY/ DRAMATIC WORK
5. Title of the work : DEMONSTRATION OF BOTH INCISION AND LACERATION IN SINGLE STEM
6. Language of the work : ENGLISH
7. Name, address and nationality of the author and if the author is deceased, date of his decease : DR. CHANDRAKANT M KOKATANUR , KRISHNA INSTITUTE OF MEDICAL SCIENCES "DEEMED TO BE UNIVERSITY", KARAD, MALKAPUR, KARAD, DIST. SATARA, MAHARASHTRA, INDIA-415539 INDIAN
8. Whether the work is published or unpublished : UNPUBLISHED
9. Year and country of first publication and name, address and nationality of the publisher : N.A.
10. Years and countries of subsequent publications, if any, and names, addresses and nationalities of the publishers : N.A.
11. Names, addresses and nationalities of the owners of various rights comprising the copyright in the work and the extent of rights held by each, together with particulars of assignments and licences, if any : KRISHNA INSTITUTE OF MEDICAL SCIENCES "DEEMED TO BE UNIVERSITY", KARAD , KRISHNA INSTITUTE OF MEDICAL SCIENCES "DEEMED TO BE UNIVERSITY", KARAD, MALKAPUR, KARAD, DIST. SATARA, MAHARASHTRA, INDIA-415539 INDIAN
12. Names, addresses and nationalities of other persons, if any, authorised to assign or licence of rights comprising the copyright : N.A.
13. If the work is an 'Artistic work', the location of the original work, including name, address and nationality of the person in possession of the work. (In the case of an architectural work, the year of completion of the work should also be shown). : N.A.
14. If the work is an 'Artistic work' which is used or capable of being used in relation to any goods or services, the application should include a certification from the Registrar of Trade Marks in terms of the provision to Sub-Section (i) of Section 45 of the Copyright Act, 1957. : N.A.
15. If the work is an 'Artistic work', whether it is registered under the Designs Act 2000 if yes give details. : N.A.
16. If the work is an 'Artistic work', capable of being registered as a design under the Designs Act 2000.whether it has been applied to an article though an industrial process and ,if yes ,the number of times it is reproduced. : N.A.
17. Remarks, if any :

Diary No. 15526/2020-CO/L
Date 10/10/2020
10/10/2020





DEPUTY REGISTRAR OF COPYRIGHTS



Dated : 02/12/2020

1. Registration Number : **L-97080/2020**
2. Name, address and nationality of the applicant : KRISHNA INSTITUTE OF MEDICAL SCIENCES“ DEEMED TO BE UNIVERSITY , NH4,PUNE -BANGALORE HIGHWAY, DIST. SATARA,AGASHIVNAGAR, MALKAPUR, MAHARASHTRA-415539 INDIAN
3. Nature of the applicant's interest in the copyright of the work : OWNER
4. Class and description of the work : LITERARY/ DRAMATIC WORK
5. Title of the work : ACADEMIC DIARY FOR FACULTY MEMBERS
6. Language of the work : ENGLISH
7. Name, address and nationality of the author and if the author is deceased, date of his decease : DR. RAJENDRA C. DOJAD , KRISHNA INSTITUTE OF MEDICAL SCIENCES“ DEEMED TO BE UNIVERSITY NH4,PUNE -BANGALORE HIGHWAY, DIST. SATARA,AGASHIVNAGAR, MALKAPUR, MAHARASHTRA-415539 INDIAN
8. Whether the work is published or unpublished : UNPUBLISHED
9. Year and country of first publication and name, address and nationality of the publisher : N.A.
10. Years and countries of subsequent publications, if any, and names, addresses and nationalities of the publishers : N.A.
11. Names, addresses and nationalities of the owners of various rights comprising the copyright in the work and the extent of rights held by each, together with particulars of assignments and licences, if any : KRISHNA INSTITUTE OF MEDICAL SCIENCES“ DEEMED TO BE UNIVERSITY , NH4,PUNE -BANGALORE HIGHWAY, DIST. SATARA,AGASHIVNAGAR, MALKAPUR, MAHARASHTRA-415539 INDIAN
12. Names, addresses and nationalities of other persons, if any, authorised to assign or licence of rights comprising the copyright : KRISHNA INSTITUTE OF MEDICAL SCIENCES“ DEEMED TO BE UNIVERSITY , NH4,PUNE -BANGALORE HIGHWAY, DIST. SATARA,AGASHIVNAGAR, MALKAPUR, MAHARASHTRA-415539 INDIAN
13. If the work is an 'Artistic work', the location of the original work, including name, address and nationality of the person in possession of the work. (In the case of an architectural work, the year of completion of the work should also be shown). : N.A.
14. If the work is an 'Artistic work' which is used or capable of being used in relation to any goods or services, the application should include a certification from the Registrar of Trade Marks in terms of the provision to Sub-Section (i) of Section 45 of the Copyright Act, 1957. : N.A.
15. If the work is an 'Artistic work', whether it is registered under the Designs Act 2000 if yes give details. : N.A.
16. If the work is an 'Artistic work', capable of being registered as a design under the Designs Act 2000.whether it has been applied to an article though an industrial process and ,if yes ,the number of times it is reproduced. : N.A.
17. Remarks, if any :



Dis: 15294/2020-CO/L
08/10/2020
08/10/2020



DEPUTY REGISTRAR OF COPYRIGHTS



Dated : 09/12/2020

1. Registration Number : **L-97358/2020**
2. Name, address and nationality of the applicant : KRISHNA INSTITUTE OF MEDICAL SCIENCES "DEEMED TO BE UNIVERSITY", NH4, PUNE - BANGALORE HIGHWAY, DIST. SATARA, AGASHIVNAGAR, MALKAPUR, MAHARASHTRA-415539
INDIAN
3. Nature of the applicant's interest in the copyright of the work : OWNER
4. Class and description of the work : LITERARY/ DRAMATIC WORK
5. Title of the work : FORMULA FOR VERTICAL DIMENSION OF OCCLUSION
6. Language of the work : ENGLISH
7. Name, address and nationality of the author and if the author is deceased, date of his decease : DR. SHUBHA JOSHI, KRISHNA INSTITUTE OF MEDICAL SCIENCES "DEEMED TO BE UNIVERSITY", NH4, PUNE - BANGALORE HIGHWAY, DIST. SATARA, AGASHIVNAGAR, MALKAPUR, MAHARASHTRA-415539
INDIAN
8. Whether the work is published or unpublished : UNPUBLISHED
9. Year and country of first publication and name, address and nationality of the publisher : N.A.
10. Years and countries of subsequent publications, if any, and names, addresses and nationalities of the publishers : N.A.
11. Names, addresses and nationalities of the owners of various rights comprising the copyright in the work and the extent of rights held by each, together with particulars of assignments and licences, if any : KRISHNA INSTITUTE OF MEDICAL SCIENCES "DEEMED TO BE UNIVERSITY", NH4, PUNE - BANGALORE HIGHWAY, DIST. SATARA, AGASHIVNAGAR, MALKAPUR, MAHARASHTRA-415539
INDIAN
12. Names, addresses and nationalities of other persons, if any, authorised to assign or licence of rights comprising the copyright : KRISHNA INSTITUTE OF MEDICAL SCIENCES "DEEMED TO BE UNIVERSITY", NH4, PUNE - BANGALORE HIGHWAY, DIST. SATARA, AGASHIVNAGAR, MALKAPUR, MAHARASHTRA-415539
INDIAN
13. If the work is an 'Artistic work', the location of the original work, including name, address and nationality of the person in possession of the work. (In the case of an architectural work, the year of completion of the work should also be shown). : N.A.
14. If the work is an 'Artistic work' which is used or capable of being used in relation to any goods or services, the application should include a certification from the Registrar of Trade Marks in terms of the provision to Sub-Section (i) of Section 45 of the Copyright Act, 1957. : N.A.
15. If the work is an 'Artistic work', whether it is registered under the Designs Act 2000 if yes give details. : N.A.
16. If the work is an 'Artistic work', capable of being registered as a design under the Designs Act 2000, whether it has been applied to an article though an industrial process and, if yes, the number of times it is reproduced. : N.A.
17. Remarks, if any :

Diary No. 14146/2020-CO/L
Date 24/09/2020
24/09/2020



DEPUTY REGISTRAR OF COPYRIGHTS



Dated : 04/12/2020

1. Registration Number : **L-97206/2020**
2. Name, address and nationality of the applicant : KRISHNA INSTITUTE OF MEDICALSCIENCES“DEEMED TO BE UNIVERSITY , NH4,PUNE -BANGALORE HIGHWAY, DIST. SATARA ,AGASHIVNAGAR, MALKAPUR, MAHARASHTRA-415539 INDIAN
3. Nature of the applicant's interest in the copyright of the work : OWNER
4. Class and description of the work : LITERARY/ DRAMATIC WORK
5. Title of the work : AN INNOVATIVE APPROACH FOR HOLLOW CHEEK PLUMBERS
6. Language of the work : ENGLISH
7. Name, address and nationality of the author and if the author is deceased, date of his decease : DR. SHUBHA JOSHI , KRISHNA INSTITUTE OF MEDICAL SCIENCES “DEEMED TO BE UNIVERSITY”, NEAR DHEBEWADI ROAD, MALKAPUR, TAL – KARAD. PIN – 415539, DIST. – SATARA, MAHARASHTRA, INDIA-415539 INDIAN
8. Whether the work is published or unpublished : UNPUBLISHED
9. Year and country of first publication and name, address and nationality of the publisher : N.A.
10. Years and countries of subsequent publications, if any, and names, addresses and nationalities of the publishers : N.A.
11. Names, addresses and nationalities of the owners of various rights comprising the copyright in the work and the extent of rights held by each, together with particulars of assignments and licences, if any : KRISHNA INSTITUTE OF MEDICALSCIENCES“DEEMED TO BE UNIVERSITY , NH4,PUNE -BANGALORE HIGHWAY, DIST. SATARA ,AGASHIVNAGAR, MALKAPUR, MAHARASHTRA-415539 INDIAN
12. Names, addresses and nationalities of other persons, if any, authorised to assign or licence of rights comprising the copyright : KRISHNA INSTITUTE OF MEDICALSCIENCES“DEEMED TO BE UNIVERSITY , NH4,PUNE -BANGALORE HIGHWAY, DIST. SATARA ,AGASHIVNAGAR, MALKAPUR, MAHARASHTRA-415539 INDIAN
13. If the work is an 'Artistic work', the location of the original work, including name, address and nationality of the person in possession of the work. (In the case of an architectural work, the year of completion of the work should also be shown). : N.A.
14. If the work is an 'Artistic work' which is used or capable of being used in relation to any goods or services, the application should include a certification from the Registrar of Trade Marks in terms of the provision to Sub-Section (i) of Section 45 of the Copyright Act, 1957. : N.A.
15. If the work is an 'Artistic work', whether it is registered under the Designs Act 2000 if yes give details. : N.A.
16. If the work is an 'Artistic work', capable of being registered as a design under the Designs Act 2000.whether it has been applied to an article though an industrial process and ,if yes ,the number of times it is reproduced. : N.A.
17. Remarks :



15779/2020-CO/L

14/10/2020

14/10/2020



DEPUTY REGISTRAR OF COPYRIGHTS



Dated : 19/10/2020

1. Registration Number : **L-95845/2020**
2. Name, address and nationality of the applicant : KRISHNA INSTITUTE OF MEDICAL SCIENCES "DEEMED TO BE UNIVERSITY", KARAD , KRISHNA INSTITUTE OF MEDICAL SCIENCES "DEEMED TO BE UNIVERSITY" NEAR DHEBEWADI ROAD, MALKAPUR, TAL-KARAD, DIST: SATARA, MAHARASHTRA, INDIA-415539
INDIAN
3. Nature of the applicant's interest in the copyright of the work : OWNER
4. Class and description of the work : LITERARY/ DRAMATIC WORK TELERADIOLOGY TEACHING FOR FINAL YEAR DENTAL STUDENTS THROUGH WHATSAPP APPLICATION
5. Title of the work : TELERADIOLOGY TEACHING FOR FINAL YEAR DENTAL STUDENTS THROUGH WHATSAPP APPLICATION
6. Language of the work : ENGLISH
7. Name, address and nationality of the author and if the author is deceased, date of his decease : DR ASHWINI RANI SR , ASSISTANT PROFESSOR, DEPARTMENT OF ORAL MEDICINE DIAGNOSIS AND RADIOLOGY, SCHOOL OF DENTAL SCIENCES, KRISHNA INSTITUTE OF MEDICAL SCIENCES "DEEMED TO BE UNIVERSITY" KARAD, MAHARASHTRA-415539
INDIAN

DR GIRISHSURAGIMATH , DEPT. OF PERIODONTOLOGY, SCHOOL OF DENTAL SCIENCES, KRISHNA INSTITUTE OF MEDICAL SCIENCES "DEEMED TO BE UNIVERSITY" NEAR DHEBEWADI ROAD, MALKAPUR, TAL-KARAD, DIST: SATARA, MAHARASHTRA, INDIA-415539
INDIAN

DR ABHIJEET SANDE , ASSISTANT PROFESSOR, DEPARTMENT OF ORAL MEDICINE DIAGNOSIS AND RADIOLOGY, SCHOOL OF DENTAL SCIENCES, KRISHNA INSTITUTE OF MEDICAL SCIENCES "DEEMED TO BE UNIVERSITY" KARAD, MAHARASHTRA-415539
INDIAN

DR SHASHIKIRAN ND , DEAN, SCHOOL OF DENTAL SCIENCES, KRISHNA INSTITUTE OF MEDICAL SCIENCES "DEEMED TO BE UNIVERSITY" KARAD, MAHARASHTRA-415539
INDIAN
8. Whether the work is published or unpublished : UNPUBLISHED
9. Year and country of first publication and name, address and nationality of the publisher : N.A.
10. Years and countries of subsequent publications, if any, and names, addresses and nationalities of the publishers : N.A.
11. Names, addresses and nationalities of the owners of various rights comprising the copyright in the work and the extent of rights held by each, together with particulars of assignments and licences, if any : KRISHNA INSTITUTE OF MEDICAL SCIENCES "DEEMED TO BE UNIVERSITY", KARAD , KRISHNA INSTITUTE OF MEDICAL SCIENCES "DEEMED TO BE UNIVERSITY" NEAR DHEBEWADI ROAD, MALKAPUR, TAL-KARAD, DIST: SATARA, MAHARASHTRA, INDIA-415539
INDIAN
12. Names, addresses and nationalities of other persons, if any, authorised to assign or licence of rights comprising the copyright : N.A.
13. If the work is an 'Artistic work', the location of the original work, names and nationality of the person in possession of an architectural work, the year of construction (where applicable) should also be shown). : N.A.
14. If the work is a 'Work of Applied Art' which is used or capable of being used in connection with goods or services, the application should be filed with the Registrar of Trade Marks in terms of the provisions of Section (i) of Section 45 of the Copyright Act, 1957. : N.A.
15. If the work is an 'Artistic work', whether it is registered under the Designs Act 2000 if yes give details. : N.A.
16. If the work is an 'Artistic work', capable of being registered as a design under the Designs Act 2000, whether it has been applied to an article though an industrial process and, if yes, the number of times it is reproduced. : N.A.



DEPUTY REGISTRAR OF COPYRIGHTS

17. Remarks, if any :

Diary Number : 11522/2020-CO/L

Date of Application : 18/08/2020

Date of Receipt : 18/08/2020



A handwritten signature in blue ink, written in a cursive style, is positioned above the printed name of the Deputy Registrar of Copyrights.

DEPUTY REGISTRAR OF COPYRIGHTS



Dated : 19/10/2020

1. Registration Number : **L-95848/2020**
2. Name, address and nationality of the applicant : KRISHNA INSTITUTE OF MEDICAL SCIENCES DEEMED TO BE UNIVERSITY, KARAD, MAHARASHTRA. , KRISHNA INSTITUTE OF MEDICAL SCIENCES DEEMED TO BE UNIVERSITY, NEAR DHEBEWADI ROAD, MALKAPUR TAL – KARAD. DIST. – SATARA, MAHARASHTRA, INDIA-415539 INDIAN
3. Nature of the applicant's interest in the copyright of the work : OWNER
4. Class and description of the work : LITERARY/ DRAMATIC WORK MUSCLE COMPRESSION RELAXATION TECHNIQUE FOR TRIGGER POINT OF TRAPEZIU
5. Title of the work : MUSCLE COMPRESSION RELAXATION TECHNIQUE FOR TRIGGER POINT OF TRAPEZIU
6. Language of the work : ENGLISH
7. Name, address and nationality of the author and if the author is deceased, date of his decease : DR.SMITA PATIL , ASSISTANT PROFESSOR, KRISHNA COLLEGE OF PHYSIOTHERAPY; KRISHNA INSTITUTE OF MEDICAL SCIENCES, DEEMED TO BE UNIVERSITY KARAD, MAHARASHTRA-415539 INDIAN
DR.CHANDRAKANT PATIL , ASSISTANT PROFESSOR, KRISHNA COLLEGE OF PHYSIOTHERAPY; KRISHNA INSTITUTE OF MEDICAL SCIENCES, DEEMED TO BE UNIVERSITY KARAD, MAHARASHTRA-415539 INDIAN
8. Whether the work is published or unpublished : UNPUBLISHED
9. Year and country of first publication and name, address and nationality of the publisher : N.A.
10. Years and countries of subsequent publications, if any, and names, addresses and nationalities of the publishers : N.A.
11. Names, addresses and nationalities of the owners of various rights comprising the copyright in the work and the extent of rights held by each, together with particulars of assignments and licences, if any : KRISHNA INSTITUTE OF MEDICAL SCIENCES DEEMED TO BE UNIVERSITY, KARAD, MAHARASHTRA. , KRISHNA INSTITUTE OF MEDICAL SCIENCES DEEMED TO BE UNIVERSITY, NEAR DHEBEWADI ROAD, MALKAPUR TAL – KARAD. DIST. – SATARA, MAHARASHTRA, INDIA-415539 INDIAN
12. Names, addresses and nationalities of other persons, if any, authorised to assign or licence of rights comprising the copyright : N.A.
13. If the work is an 'Artistic work', the location of the original work, including name, address and nationality of the person in possession of the work. (In the case of an architectural work, the year of completion of the work should also be shown). : N.A.
14. If the work is an 'Artistic work' which is used or capable of being used in relation to any goods or services, the application should include a certification from the Registrar of Trade Marks in terms of the provision to Sub-Section (i) of Section 45 of the Copyright Act, 1957. : N.A.
15. If the work is an 'Artistic work', whether it is registered under the Designs Act, 2000, if yes give details. : N.A.
16. If the work is an 'Artistic work', capable of being registered as a trademark under the Trademarks Act 2000.whether it has been applied to an article, if yes, the number of times : N.A.
17. :



Di No : 11534/2020-CO/L
Date of Application : 18/08/2020
Date of Receipt : 18/08/2020

DEPUTY REGISTRAR OF COPYRIGHTS



Dated : 19/11/2020

1. Registration Number : **L-96804/2020**
2. Name, address and nationality of the applicant : KRISHNA INSTITUTE OF MEDICAL SCIENCES DEEMED TO BE UNIVERSITY, KARAD, MAHARASHTRA , KRISHNA INSTITUTE OF MEDICAL SCIENCES "DEEMED TO BE UNIVERSITY" NEAR DHEBEWADI ROAD, MALKAPUR, TAL-KARAD, DIST: SATARA, MAHARASHTRA, INDIA-415539
INDIAN
3. Nature of the applicant's interest in the copyright of the work : OWNER
4. Class and description of the work : LITERARY/ DRAMATIC WORK MNEMONICS FOR REMEMBERING SCHEDULES TO THE ACT, AS PER DRUGS AND COSMETICS ACT, 1940 AND RULES MADE THEREUNDER.
5. Title of the work : MNEMONICS FOR REMEMBERING SCHEDULES TO THE ACT, AS PER DRUGS AND COSMETICS ACT, 1947 AND RULES MADE THEREUNDER
6. Language of the work : ENGLISH
7. Name, address and nationality of the author and if the author is deceased, date of his decease : MRS. NUTAN VISHAL SHAH , LECTURER, KRISHNA CHARITABLE TRUST'S, KRISHNA COLLEGE OF PHARMACY, KARAD-415539
INDIAN

MR. VISHAL VILAS SHAH , ASSISTANT PROFESSOR, DEPT. OF PHARMACEUTICAL CHEMISTRY,
KRISHNA INSTITUTE OF PHARMACY, KIMSDTU, KARAD-415539
INDIAN

MRS. SHUBHANGI A. PATIL , PRINCIPAL, KRISHNA COLLEGE OF PHARMACY, KARAD-415539
INDIAN
8. Whether the work is published or unpublished : UNPUBLISHED
9. Year and country of first publication and name, address and nationality of the publisher : N.A.
10. Years and countries of subsequent publications, if any, and names, addresses and nationalities of the publishers : N.A.
11. Names, addresses and nationalities of the owners of various rights comprising the copyright in the work and the extent of rights held by each, together with particulars of assignments and licences, if any : KRISHNA INSTITUTE OF MEDICAL SCIENCES DEEMED TO BE UNIVERSITY, KARAD, MAHARASHTRA , KRISHNA INSTITUTE OF MEDICAL SCIENCES "DEEMED TO BE UNIVERSITY" NEAR DHEBEWADI ROAD, MALKAPUR, TAL-KARAD, DIST: SATARA, MAHARASHTRA, INDIA-415539
INDIAN
12. Names, addresses and nationalities of other persons, if any, authorised to assign or licence of rights comprising the copyright : N.A.
13. If the work is an 'Artistic work', the location of the original work, including name, address and nationality of the person in possession of the work. (In the case of an architectural work, the year of completion of the work should also be shown). : N.A.
14. If the work is an 'Artistic work' which is used or capable of being used in connection to any goods or services, the application should include information from the Registrar of Trade Marks in terms of the Section (i) of Section 45 of the Copyright Act, : N.A.
15. If the work is a 'Literary work', whether it is registered under the : N.A.
Give details.
16. If the work is a 'Literary work', capable of being registered as a : N.A.
designs Act 2000. whether it has been applied to an
artistic work, industrial process and ,if yes ,the number of times
it is registered.
17. Remarks, if any :

Diary Number : 15528/2020-CO/L
Date of Application : 10/10/2020
Date of Receipt : 10/10/2020

DEPUTY REGISTRAR OF COPYRIGHTS



Dated : 03/12/2020

1. Registration Number : **L-97129/2020**
2. Name, address and nationality of the applicant : KRISHNA INSTITUTE OF MEDICAL SCIENCES "DEEMED TO BE UNIVERSITY", KARAD , KRISHNA INSTITUTE OF MEDICAL SCIENCES "DEEMED TO BE UNIVERSITY", KARAD, MALKAPUR, KARAD, DIST. SATARA, MAHARASHTRA, INDIA-415539
INDIAN
3. Nature of the applicant's interest in the copyright of the work : OWNER
4. Class and description of the work : LITERARY/ DRAMATIC WORK
5. Title of the work : THE THOUGHT BUBBLE EFFECT
6. Language of the work : ENGLISH
7. Name, address and nationality of the author and if the author is deceased, date of his decease : DR. SACHIN GUGWAD , KRISHNA INSTITUTE OF MEDICAL SCIENCES "DEEMED TO BE UNIVERSITY", KARAD, MALKAPUR, KARAD, DIST. SATARA, MAHARASHTRA, INDIA-415539
INDIAN

HRUTUJA DESHPANDE , KRISHNA INSTITUTE OF MEDICAL SCIENCES "DEEMED TO BE UNIVERSITY", KARAD, MALKAPUR, KARAD, DIST. SATARA, MAHARASHTRA, INDIA-415539
INDIAN

PRACHI DHURYE , KRISHNA INSTITUTE OF MEDICAL SCIENCES "DEEMED TO BE UNIVERSITY", KARAD, MALKAPUR, KARAD, DIST. SATARA, MAHARASHTRA, INDIA-415539
INDIAN
8. Whether the work is published or unpublished : UNPUBLISHED
9. Year and country of first publication and name, address and nationality of the publisher : N.A.
10. Years and countries of subsequent publications, if any, and names, addresses and nationalities of the publishers : N.A.
11. Names, addresses and nationalities of the owners of various rights comprising the copyright in the work and the extent of rights held by each, together with particulars of assignments and licences, if any : KRISHNA INSTITUTE OF MEDICAL SCIENCES "DEEMED TO BE UNIVERSITY", KARAD , KRISHNA INSTITUTE OF MEDICAL SCIENCES "DEEMED TO BE UNIVERSITY", KARAD, MALKAPUR, KARAD, DIST. SATARA, MAHARASHTRA, INDIA-415539
INDIAN
12. Names, addresses and nationalities of other persons, if any, authorised to assign or licence of rights comprising the copyright : N.A.
13. If the work is an 'Artistic work', the location of the original work, including name, address and nationality of the person in possession of the work. (In the case of an architectural work, the year of completion of the work should also be shown). : N.A.
14. If the work is an 'Artistic work' which is used or capable of being used in relation to any goods or services, the application should include a certification from the Registrar of Trade Marks in terms of the provision to Sub-Section (i) of Section 45 of the Copyright Act, 1957. : N.A.
15. If the work is an 'Artistic work', whether it is registered under the Copyright Act, 1957, give details. : N.A.
16. If the work is an 'Artistic work', capable of being registered as a trademark under the Trademarks Act 2000, whether it has been applied to an article, the date of application, the date of registration, if any, and the date of the process and ,if yes ,the number of times : N.A.
17. : N.A.





DEPUTY REGISTRAR OF COPYRIGHTS

Diary : 14907/2020-CO/L

Date of Application : 05/10/2020

Date of Receipt : 05/10/2020



Dated : 03/12/2020

1. Registration Number : **L-97118/2020**
2. Name, address and nationality of the applicant : KRISHNA INSTITUTE OF MEDICAL SCIENCES, DEEMED TO BE UNIVERSITY, KARAD , KARAD DHEBEWADI ROAD, PUNE BANGLORE NH 04 , MALKAPUR, KARAD-415339 INDIAN
3. Nature of the applicant's interest in the copyright of the work : OWNER
4. Class and description of the work : LITERARY/ DRAMATIC WORK
5. Title of the work : ANTI-INFLAMMATORY AND IMMUNOSUPPRESSANT ACTIONS OF THIAZOLIDINEDIONES
6. Language of the work : ENGLISH
7. Name, address and nationality of the author and if the author is deceased, date of his decease : N.A.
8. Whether the work is published or unpublished : UNPUBLISHED
9. Year and country of first publication and name, address and nationality of the publisher : N.A.
10. Years and countries of subsequent publications, if any, and names, addresses and nationalities of the publishers : N.A.
11. Names, addresses and nationalities of the owners of various rights comprising the copyright in the work and the extent of rights held by each, together with particulars of assignments and licences, if any : N.A.
12. Names, addresses and nationalities of other persons, if any, authorised to assign or licence of rights comprising the copyright : N.A.
13. If the work is an 'Artistic work', the location of the original work, including name, address and nationality of the person in possession of the work. (In the case of an architectural work, the year of completion of the work should also be shown). : N.A.
14. If the work is an 'Artistic work' which is used or capable of being used in relation to any goods or services, the application should include a certification from the Registrar of Trade Marks in terms of the provision to Sub-Section (i) of Section 45 of the Copyright Act, 1957. : N.A.
15. If the work is an 'Artistic work', whether it is registered under the Designs Act 2000 if yes give details. : N.A.
16. If the work is an 'Artistic work', capable of being registered as a design under the Designs Act 2000, whether it has been applied to an article through an industrial process and, if yes, the number of times it is reproduced. : N.A.
17. Remarks, if any :

Diary Number : 14952/2020-CO/L

Date of Application : 05/10/2020

Date of Receipt : 05/10/2020





DEPUTY REGISTRAR OF COPYRIGHTS



Dated : 11/12/2020

1. Registration Number : **L-97518/2020**
2. Name, address and nationality of the applicant : KRISHNA INSTITUTE OF MEDICAL SCIENCES "DEEMED TO BE UNIVERSITY , NH4, PUNE - BANGALORE HIGHWAY, DIST.SATARA, AGASHIVNAGAR, MALKAPUR, MAHARASHTRA-415539 INDIAN
3. Nature of the applicant's interest in the copyright of the work : OWNER
4. Class and description of the work : LITERARY/ DRAMATIC WORK
5. Title of the work : DENTAL OFFICE STANDARD OPERATING PROCEDURES IN COVID-19 ERA
6. Language of the work : ENGLISH
7. Name, address and nationality of the author and if the author is deceased, date of his decease : DR. JAYASHREE MANIKANDAN , KRISHNA INSTITUTE OF MEDICAL SCIENCES "DEEMED TO BE UNIVERSITY NH4, PUNE - BANGALORE HIGHWAY, DIST.SATARA, AGASHIVNAGAR, MALKAPUR, MAHARASHTRA-415539 INDIAN
DR. RENUKA PAWAR , KRISHNA INSTITUTE OF MEDICAL SCIENCES "DEEMED TO BE UNIVERSITY NH4, PUNE - BANGALORE HIGHWAY, DIST.SATARA, AGASHIVNAGAR, MALKAPUR, MAHARASHTRA-415539 INDIAN
8. Whether the work is published or unpublished : UNPUBLISHED
9. Year and country of first publication and name, address and nationality of the publisher : N.A.
10. Years and countries of subsequent publications, if any, and names, addresses and nationalities of the publishers : N.A.
11. Names, addresses and nationalities of the owners of various rights comprising the copyright in the work and the extent of rights held by each, together with particulars of assignments and licences, if any : KRISHNA INSTITUTE OF MEDICAL SCIENCES "DEEMED TO BE UNIVERSITY , NH4, PUNE - BANGALORE HIGHWAY, DIST.SATARA, AGASHIVNAGAR, MALKAPUR, MAHARASHTRA-415539 INDIAN
12. Names, addresses and nationalities of other persons, if any, authorised to assign or licence of rights comprising the copyright : KRISHNA INSTITUTE OF MEDICAL SCIENCES "DEEMED TO BE UNIVERSITY , NH4, PUNE - BANGALORE HIGHWAY, DIST.SATARA, AGASHIVNAGAR, MALKAPUR, MAHARASHTRA-415539 INDIAN
13. If the work is an 'Artistic work', the location of the original work, including name, address and nationality of the person in possession of the work. (In the case of an architectural work, the year of completion of the work should also be shown). : N.A.
14. If the work is an 'Artistic work' which is used or capable of being used in relation to any goods or services, the application should include a certification from the Registrar of Trade Marks in terms of the provision to Sub-Section (i) of Section 45 of the Copyright Act, 1957. : N.A.
15. If the work is an 'Artistic work', whether it is registered under the Designs Act, 2000, if yes give details. : N.A.
16. If the work is an 'Artistic work', capable of being registered as a trademark under the Trademarks Act 2000, whether it has been applied to an application for registration, if yes, the number of times : N.A.
17. :



Di : 13836/2020-CO/L
Date of Application : 21/09/2020
Date of Receipt : 21/09/2020

DEPUTY REGISTRAR OF COPYRIGHTS



Dated : 11/12/2020

1. Registration Number : **L-97540/2020**
2. Name, address and nationality of the applicant : KRISHNA INSTITUTE OF MEDICAL SCIENCES "DEEMED TO BE UNIVERSITY , NH4, PUNE -BANGALORE HIGHWAY, DIST.SATARA, AGASHIVNAGAR, MALKAPUR,MAHARASHTRA-415539 INDIAN
3. Nature of the applicant's interest in the copyright of the work : OWNER
4. Class and description of the work : LITERARY/ DRAMATIC WORK
5. Title of the work : "FOGGY-GLASS SYNDROME": EMERGING ADVERSE EFFECT AMIDST COVID-19 PANDEMIC
6. Language of the work : ENGLISH
7. Name, address and nationality of the author and if the author is deceased, date of his decease : DR.PRASANNAJEET PRAMOD NIKAM , KRISHNA INSTITUTE OF MEDICAL SCIENCES "DEEMED TO BE UNIVERSITY NH4, PUNE - BANGALORE HIGHWAY,DIST.SATARA, AGASHIVNAGAR, MALKAPUR, MAHARASHTRA-415539 INDIAN
DR.GOVINDHAN VARADHARAJULU , KRISHNA INSTITUTE OF MEDICAL SCIENCES "DEEMED TO BE UNIVERSITY NH4, PUNE - BANGALORE HIGHWAY,DIST.SATARA, AGASHIVNAGAR, MALKAPUR, MAHARASHTRA-415539 INDIAN
8. Whether the work is published or unpublished : UNPUBLISHED
9. Year and country of first publication and name, address and nationality of the publisher : N.A.
10. Years and countries of subsequent publications, if any, and names, addresses and nationalities of the publishers : N.A.
11. Names, addresses and nationalities of the owners of various rights comprising the copyright in the work and the extent of rights held by each, together with particulars of assignments and licences, if any : KRISHNA INSTITUTE OF MEDICAL SCIENCES "DEEMED TO BE UNIVERSITY , NH4, PUNE -BANGALORE HIGHWAY, DIST.SATARA, AGASHIVNAGAR, MALKAPUR,MAHARASHTRA-415539 INDIAN
12. Names, addresses and nationalities of other persons, if any, authorised to assign or licence of rights comprising the copyright : KRISHNA INSTITUTE OF MEDICAL SCIENCES "DEEMED TO BE UNIVERSITY , NH4, PUNE -BANGALORE HIGHWAY, DIST.SATARA, AGASHIVNAGAR, MALKAPUR,MAHARASHTRA-415539 INDIAN
13. If the work is an 'Artistic work', the location of the original work, including name, address and nationality of the person in possession of the work. (In the case of an architectural work, the year of completion of the work should also be shown). : N.A.
14. If the work is an 'Artistic work' which is used or capable of being used in relation to any goods or services, the application should include a certification from the Registrar of Trade Marks in terms of the provision to Sub-Section (i) of Section 45 of the Copyright Act, 1957. : N.A.
15. If the work is an 'Artistic work', whether it is registered under the Designs Act 2000 if yes give details. : N.A.
16. If the work is an 'Artistic work', capable of being registered as a design under the Designs Act 2000, whether it has been applied to an industrial process and ,if yes ,the number of times : N.A.
17. :



13862/2020-CO/L

Date of Receipt : 22/09/2020

Date of Receipt : 22/09/2020

DEPUTY REGISTRAR OF COPYRIGHTS



Dated : 10/12/2020

- | | | |
|---|---|--|
| 1. Registration Number | : | L-97512/2020 |
| 2. Name, address and nationality of the applicant | : | KRISHNA INSTITUTE OF MEDICAL SCIENCES DEEMED TO BE UNIVERSITY, KARAD, MAHARASHTRA , KRISHNA INSTITUTE OF MEDICAL SCIENCES "DEEMED TO BE UNIVERSITY" NEAR DHEBEWADI ROAD, MALKAPUR, TAL-KARAD, DIST: SATARA, MAHARASHTRA, INDIA-415539
INDIAN |
| 3. Nature of the applicant's interest in the copyright of the work | : | OWNER |
| 4. Class and description of the work | : | LITERARY/ DRAMATIC WORK |
| 5. Title of the work | : | BREATHE CHECKLIST FOR REDUCING PSYCHOLOGICAL STRESSES DUE TO CORONA PHOBIA |
| 6. Language of the work | : | ENGLISH |
| 7. Name, address and nationality of the author and if the author is deceased, date of his decease | : | 1.DR.PRASANNAJEET PRAMOD NIKAM , ASSISTANT PROFESSOR ; KRISHNA COLLEGE OF PHYSIOTHERAPY, KARAD; DEPARTMENT OF SPORTS PHYSIOTHERAPY; KRISHNA INSTITUTE OF MEDICAL SCIENCES DEEMED TO BE UNIVERSITY, KARAD, MAHARASHTRA, INDIA-INDIAN

2. DR.G.VARADHARAJULU , DEAN; FACULTY OF PHYSIOTHERAPY; KRISHNA COLLEGE OF PHYSIOTHERAPY, KARAD; DEPARTMENT OF NEUROSCIENCES; KRISHNA INSTITUTE OF MEDICAL SCIENCES DEEMED TO BE UNIVERSITY, KARAD, MAHARASHTRA, INDIA-INDIAN |
| 8. Whether the work is published or unpublished | : | UNPUBLISHED |
| 9. Year and country of first publication and name, address and nationality of the publisher | : | N.A. |
| 10. Years and countries of subsequent publications, if any, and names, addresses and nationalities of the publishers | : | N.A. |
| 11. Names, addresses and nationalities of the owners of various rights comprising the copyright in the work and the extent of rights held by each, together with particulars of assignments and licences, if any | : | KRISHNA INSTITUTE OF MEDICAL SCIENCES DEEMED TO BE UNIVERSITY, KARAD, MAHARASHTRA , KRISHNA INSTITUTE OF MEDICAL SCIENCES "DEEMED TO BE UNIVERSITY" NEAR DHEBEWADI ROAD, MALKAPUR, TAL-KARAD, DIST: SATARA, MAHARASHTRA, INDIA-415539
INDIAN |
| 12. Names, addresses and nationalities of other persons, if any, authorised to assign or licence of rights comprising the copyright | : | N.A. |
| 13. If the work is an 'Artistic work', the location of the original work, including name, address and nationality of the person in possession of the work. (In the case of an architectural work, the year of completion of the work should also be shown). | : | N.A. |
| 14. If the work is an 'Artistic work' which is used or capable of being used in relation to any goods or services, the application should include a notification from the Registrar of Trade Marks in terms of the proviso to Section (i) of Section 45 of the Copyright Act, 1957. | : | N.A. |
| 15. If the work is an 'Artistic work', whether it is registered under the Copyright Act, 1957, give details. | : | N.A. |
| 16. If the work is an 'Artistic work', capable of being registered as a work under the Copyright Act 2000, whether it has been applied to an industrial process and ,if yes ,the number of times it has been so applied. | : | N.A. |
| 17. Remarks, if any | : | |

Diary Number : 13880/2020-CO/L
Date of Application : 22/09/2020
Date of Receipt : 22/09/2020

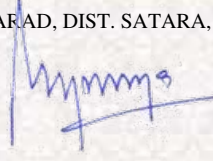
DEPUTY REGISTRAR OF COPYRIGHTS



Dated : 11/12/2020

1. Registration Number : **L-97542/2020**
2. Name, address and nationality of the applicant : KRISHNA INSTITUTE OF MEDICAL SCIENCES "DEEMED TO BE UNIVERSITY ADDRESS , NH4, PUNE -BANGALORE HIGHWAY, DIST.SATARA, AGASHIVNAGAR, MALKAPUR,MAHARASHTRA-415539 INDIAN
3. Nature of the applicant's interest in the copyright of the work : OWNER
4. Class and description of the work : LITERARY/ DRAMATIC WORK
5. Title of the work : MIND MAP OF MUCOADHESIVE DRUG DELIVERY SYSTEM
6. Language of the work : ENGLISH
7. Name, address and nationality of the author and if the author is deceased, date of his decease : DR. AMOL S. SHETE , KRISHNAINSTITUTE OF MEDICAL SCIENCES "DEEMED TO BEUNIVERSITY NH4, PUNE - BANGALORE HIGHWAY,DIST.SATARA, AGASHIVNAGAR, MALKAPUR, MAHARASHTRA-415539 INDIAN
DR. RAJENDRA C. DOJJAD , KRISHNA INSTITUTE OF MEDICAL SCIENCES "DEEMED TO BEUNIVERSITY NH4, PUNE - BANGALORE HIGHWAY, DIST. SATARA, AGASHIVNAGAR, MALKAPUR, MAHARASHTRA-415539 INDIAN
8. Whether the work is published or unpublished : UNPUBLISHED
9. Year and country of first publication and name, address and nationality of the publisher : N.A.
10. Years and countries of subsequent publications, if any, and names, addresses and nationalities of the publishers : N.A.
11. Names, addresses and nationalities of the owners of various rights comprising the copyright in the work and the extent of rights held by each, together with particulars of assignments and licences, if any : KRISHNA INSTITUTE OF MEDICAL SCIENCES "DEEMED TO BE UNIVERSITY ADDRESS , NH4, PUNE -BANGALORE HIGHWAY, DIST.SATARA, AGASHIVNAGAR, MALKAPUR,MAHARASHTRA-415539 INDIAN
12. Names, addresses and nationalities of other persons, if any, authorised to assign or licence of rights comprising the copyright : KRISHNA INSTITUTE OF MEDICAL SCIENCES "DEEMED TO BE UNIVERSITY ADDRESS , NH4, PUNE -BANGALORE HIGHWAY, DIST.SATARA, AGASHIVNAGAR, MALKAPUR,MAHARASHTRA-415539 INDIAN
13. If the work is an 'Artistic work', the location of the original work, including name, address and nationality of the person in possession of the work. (In the case of an architectural work, the year of completion of the work should also be shown). : N.A.
14. If the work is an 'Artistic work' which is used or capable of being used in relation to any goods or services, the application should include a certification from the Registrar of Trade Marks in terms of the provision to Sub-Section (i) of Section 45 of the Copyright Act, 1957. : N.A.
15. If the work is an 'Artistic work', whether it is registered under the Designs Act 2000 if yes give details. : N.A.
16. If the work is an 'Artistic work', capable of being registered as a design under the Designs Act 2000.whether it has been applied to an article, industrial process and ,if yes ,the number of times it has been so applied. : N.A.
17. :



13882/2020-CO/L

22/09/2020

Date

22/09/2020

DEPUTY REGISTRAR OF COPYRIGHTS



Dated : 11/12/2020

1. Registration Number : **L-97544/2020**
2. Name, address and nationality of the applicant : KRISHNA INSTITUTE OF MEDICAL SCIENCES "DEEMED TO BE UNIVERSITY", NH4, PUNE -BANGALORE HIGHWAY, DIST. SATARA, AGASHIVNAGAR, MALKAPUR, MAHARASHTRA-415539
INDIAN
3. Nature of the applicant's interest in the copyright of the work : OWNER
4. Class and description of the work : LITERARY/ DRAMATIC WORK
5. Title of the work : BIOPSY PROCEDURE IN DENTISTRY [CONSENT FORM]
6. Language of the work : ENGLISH
7. Name, address and nationality of the author and if the author is deceased, date of his decease : DR. PRERNA BARGE, KRISHNA INSTITUTE OF MEDICAL SCIENCES "DEEMED TO BE UNIVERSITY NH4, PUNE - BANGALORE HIGHWAY, DIST. SATARA, AGASHIVNAGAR, MALKAPUR, MAHARASHTRA-415539
INDIAN

DR. SHASHIKIRAN ND, KRISHNA INSTITUTE OF MEDICAL SCIENCES "DEEMED TO BE UNIVERSITY NH4, PUNE - BANGALORE HIGHWAY, DIST. SATARA, AGASHIVNAGAR, MALKAPUR, MAHARASHTRA-415539
INDIAN

DR. SAVITA HADKAR, KRISHNA INSTITUTE OF MEDICAL SCIENCES "DEEMED TO BE UNIVERSITY NH4, PUNE - BANGALORE HIGHWAY, DIST. SATARA, AGASHIVNAGAR, MALKAPUR, MAHARASHTRA-415539
INDIAN
8. Whether the work is published or unpublished : UNPUBLISHED
9. Year and country of first publication and name, address and nationality of the publisher : N.A.
10. Years and countries of subsequent publications, if any, and names, addresses and nationalities of the publishers : N.A.
11. Names, addresses and nationalities of the owners of various rights comprising the copyright in the work and the extent of rights held by each, together with particulars of assignments and licences, if any : KRISHNA INSTITUTE OF MEDICAL SCIENCES "DEEMED TO BE UNIVERSITY", NH4, PUNE -BANGALORE HIGHWAY, DIST. SATARA, AGASHIVNAGAR, MALKAPUR, MAHARASHTRA-415539
INDIAN
12. Names, addresses and nationalities of other persons, if any, authorised to assign or licence of rights comprising the copyright : KRISHNA INSTITUTE OF MEDICAL SCIENCES "DEEMED TO BE UNIVERSITY", NH4, PUNE -BANGALORE HIGHWAY, DIST. SATARA, AGASHIVNAGAR, MALKAPUR, MAHARASHTRA-415539
INDIAN
13. If the work is an 'Artistic work', the location of the original work, including name, address and nationality of the person in possession of the work. (In the case of an architectural work, the year of completion of the work should also be shown). : N.A.
14. If the work is an 'Artistic work' which is used or capable of being used in relation to any goods or services, the application should include a certification from the Registrar of Trade Marks in terms of the provision to Sub-Section (i) of Section 45 of the Copyright Act, 1957. : N.A.
15. If the work is an 'Artistic work', whether it is registered under the Copyright Act, 1957, give details. : N.A.
16. If the work is an 'Artistic work', capable of being registered as a trademark under the Trademarks Act 2000, whether it has been applied to an article, the date of application, the date of registration, if any, and the date of the process and, if yes, the number of times : N.A.
17. Registrar : 
DEPUTY REGISTRAR OF COPYRIGHTS

Diary Number : 13889/2020-CO/L

Date of Application : 22/09/2020

Date of Receipt : 22/09/2020





Dated : 10/12/2020

1. Registration Number : **L-97495/2020**
2. Name, address and nationality of the applicant : KRISHNA INSTITUTE OF MEDICAL SCIENCES DEEMED TO BE UNIVERSITY, KARAD, MAHARASHTRA. , KRISHNA INSTITUTE OF MEDICAL SCIENCES "DEEMED TO BE UNIVERSITY" NEAR DHEBEWADI ROAD, MALKAPUR, TAL-KARAD, DIST: SATARA, MAHARASHTRA, INDIA-415539
INDIAN
3. Nature of the applicant's interest in the copyright of the work : OWNER
4. Class and description of the work : LITERARY/ DRAMATIC WORK
5. Title of the work : ONLINE EXAMINATION IN THE FORM OF ASSIGNMENT
6. Language of the work : ENGLISH
7. Name, address and nationality of the author and if the author is deceased, date of his decease : DR. VIDYA KADASHETTI , SCHOOL OF DENTAL SCIENCES
KRISHNA INSTITUTE OF MEDICAL SCIENCES "DEEMED TO BE UNIVERSITY", KARAD-415539
INDIAN

DR. SHASHI KIRAN. N.D , SCHOOL OF DENTAL SCIENCES
KRISHNA INSTITUTE OF MEDICAL SCIENCES "DEEMED TO BE UNIVERSITY", KARAD-415539
INDIAN

DR. NAMRATA GAONKAR , SCHOOL OF DENTAL SCIENCES
KRISHNA INSTITUTE OF MEDICAL SCIENCES "DEEMED TO BE UNIVERSITY", KARAD-415539
INDIAN
8. Whether the work is published or unpublished : UNPUBLISHED
9. Year and country of first publication and name, address and nationality of the publisher : N.A.
10. Years and countries of subsequent publications, if any, and names, addresses and nationalities of the publishers : N.A.
11. Names, addresses and nationalities of the owners of various rights comprising the copyright in the work and the extent of rights held by each, together with particulars of assignments and licences, if any : KRISHNA INSTITUTE OF MEDICAL SCIENCES DEEMED TO BE UNIVERSITY, KARAD, MAHARASHTRA. , KRISHNA INSTITUTE OF MEDICAL SCIENCES "DEEMED TO BE UNIVERSITY" NEAR DHEBEWADI ROAD, MALKAPUR, TAL-KARAD, DIST: SATARA, MAHARASHTRA, INDIA-415539
INDIAN
12. Names, addresses and nationalities of other persons, if any, authorised to assign or licence of rights comprising the copyright : N.A.
13. If the work is an 'Artistic work', the location of the original work, including name, address and nationality of the person in possession of the work. (In the case of an architectural work, the year of completion of the work should also be shown). : N.A.
14. If the work is an 'Artistic work' which is used or capable of being used in relation to any goods or services, the application should include a certification from the Registrar of Trade Marks in terms of the provision to Sub-Section (i) of Section 45 of the Copyright Act, 1957. : N.A.
15. If the work is an 'Artistic work', whether it is registered under the Designs Act, 2000, if yes give details. : N.A.
16. If the work is an 'Artistic work', capable of being registered as a trademark under the Trademarks Act 2000, whether it has been applied to an application for registration, if yes, the number of times : N.A.
17. :



Dis No : 13891/2020-CO/L
Date of Application : 22/09/2020
Date of Receipt : 22/09/2020

DEPUTY REGISTRAR OF COPYRIGHTS



Dated : 11/12/2020

1. Registration Number : **L-97545/2020**
2. Name, address and nationality of the applicant : KRISHNA INSTITUTE OF MEDICAL SCIENCES"DEEMED TO BE UNIVERSITY , NH4, PUNE -BANGALORE HIGHWAY, DIST.SATARA, AGASHIVNAGAR, MALKAPUR,MAHARASHTRA-415539 INDIAN
3. Nature of the applicant's interest in the copyright of the work : OWNER
4. Class and description of the work : LITERARY/ DRAMATIC WORK
5. Title of the work : USE OF PATIENTS RECORD FOR PUBLICATION AND EDUCATION [CONSENT FORM]
6. Language of the work : ENGLISH
7. Name, address and nationality of the author and if the author is deceased, date of his decease : DR. PRERNA BARGE , KRISHNA INSTITUTE OF MEDICAL SCIENCES "DEEMED TO BEUNIVERSITY NH4, PUNE - BANGALORE HIGHWAY,DIST.SATARA, AGASHIVNAGAR, MALKAPUR, MAHARASHTRA-415539 INDIAN
DR. SHASHIKIRAN ND , KRISHNA INSTITUTE OF MEDICAL SCIENCES "DEEMED TO BEUNIVERSITY NH4, PUNE - BANGALORE HIGHWAY, DIST. SATARA, AGASHIVNAGAR, MALKAPUR, MAHARASHTRA-415539 INDIAN
DR. CHANDRAKANT M KOKATANUR , KRISHNA INSTITUTE OF MEDICAL SCIENCES "DEEMED TO BEUNIVERSITY NH4, PUNE - BANGALORE HIGHWAY, DIST. SATARA, AGASHIVNAGAR, MALKAPUR, MAHARASHTRA-415539 INDIAN
8. Whether the work is published or unpublished : UNPUBLISHED
9. Year and country of first publication and name, address and nationality of the publisher : N.A.
10. Years and countries of subsequent publications, if any, and names, addresses and nationalities of the publishers : N.A.
11. Names, addresses and nationalities of the owners of various rights comprising the copyright in the work and the extent of rights held by each, together with particulars of assignments and licences, if any : KRISHNA INSTITUTE OF MEDICAL SCIENCES"DEEMED TO BE UNIVERSITY , NH4, PUNE -BANGALORE HIGHWAY, DIST.SATARA, AGASHIVNAGAR, MALKAPUR,MAHARASHTRA-415539 INDIAN
12. Names, addresses and nationalities of other persons, if any, authorised to assign or licence of rights comprising the copyright : KRISHNA INSTITUTE OF MEDICAL SCIENCES"DEEMED TO BE UNIVERSITY , NH4, PUNE -BANGALORE HIGHWAY, DIST.SATARA, AGASHIVNAGAR, MALKAPUR,MAHARASHTRA-415539 INDIAN
13. If the work is an 'Artistic work', the location of the original work, including name, address and nationality of the person in possession of the work. (In the case of an architectural work, the year of completion of the work should also be shown). : N.A.
14. If the work is an 'Artistic work' which is used or capable of being used in relation to any goods or services, the application should include a notification from the Registrar of Trade Marks in terms of the said Section (i) of Section 45 of the Copyright Act, 1957 : N.A.
15. If the work is an 'Artistic work', whether it is registered under the Copyright Act, 1957, give details. : N.A.
16. If the work is an 'Artistic work', capable of being registered as a trademark under the Trademarks Act 2000, whether it has been applied to an industrial process and ,if yes ,the number of times it is so applied : N.A.
17. Remarks, if any :

Diary Number : 13893/2020-CO/L
Date of Application : 22/09/2020
Date of Receipt : 22/09/2020



DEPUTY REGISTRAR OF COPYRIGHTS



Dated : 11/12/2020

1. Registration Number : **L-97548/2020**
2. Name, address and nationality of the applicant : KRISHNA INSTITUTE OF MEDICAL SCIENCES "DEEMED TO BE UNIVERSITY", NH4, PUNE -BANGALORE HIGHWAY, DIST.SATARA, AGASHIVNAGAR, MALKAPUR,MAHARASHTRA-415539
INDIAN
3. Nature of the applicant's interest in the copyright of the work : OWNER
4. Class and description of the work : LITERARY/ DRAMATIC WORK
5. Title of the work : PULPECTOMY OF PRIMARY TEETH [CONSENT FORM]
6. Language of the work : ENGLISH
7. Name, address and nationality of the author and if the author is deceased, date of his decease : DR. PRERNA BARGE, KRISHNA INSTITUTE OF MEDICAL SCIENCES "DEEMED TO BE UNIVERSITY NH4, PUNE - BANGALORE HIGHWAY, DIST. SATARA, AGASHIVNAGAR, MALKAPUR, MAHARASHTRA-415539
INDIAN

DR. SACHIN GUGAWAD, KRISHNA INSTITUTE OF MEDICAL SCIENCES "DEEMED TO BE UNIVERSITY NH4, PUNE - BANGALORE HIGHWAY, DIST. SATARA, AGASHIVNAGAR, MALKAPUR, MAHARASHTRA-415539
INDIAN

DR. SHASHIKIRAN ND, KRISHNA INSTITUTE OF MEDICAL SCIENCES "DEEMED TO BE UNIVERSITY NH4, PUNE - BANGALORE HIGHWAY, DIST. SATARA, AGASHIVNAGAR, MALKAPUR, MAHARASHTRA-415539
INDIAN
8. Whether the work is published or unpublished : UNPUBLISHED
9. Year and country of first publication and name, address and nationality of the publisher : N.A.
10. Years and countries of subsequent publications, if any, and names, addresses and nationalities of the publishers : N.A.
11. Names, addresses and nationalities of the owners of various rights comprising the copyright in the work and the extent of rights held by each, together with particulars of assignments and licences, if any : KRISHNA INSTITUTE OF MEDICAL SCIENCES "DEEMED TO BE UNIVERSITY", NH4, PUNE -BANGALORE HIGHWAY, DIST.SATARA, AGASHIVNAGAR, MALKAPUR,MAHARASHTRA-415539
INDIAN
12. Names, addresses and nationalities of other persons, if any, authorised to assign or licence of rights comprising the copyright : KRISHNA INSTITUTE OF MEDICAL SCIENCES "DEEMED TO BE UNIVERSITY", NH4, PUNE -BANGALORE HIGHWAY, DIST.SATARA, AGASHIVNAGAR, MALKAPUR,MAHARASHTRA-415539
INDIAN
13. If the work is an 'Artistic work', the location of the original work, including name, address and nationality of the person in possession of the work. (In the case of an architectural work, the year of completion of the work should also be shown). : N.A.
14. If the work is an 'Artistic work' which is used or capable of being used in relation to any goods or services, the application should include a certification from the Registrar of Trade Marks in terms of the provision to Sub-Section (i) of Section 45 of the Copyright Act, 1957. : N.A.
15. If the work is an 'Artistic work', whether it is registered under the Copyright Act, 1957, give details. : N.A.
16. If the work is an 'Artistic work', capable of being registered as a trademark under the Trademarks Act 2000, whether it has been applied to an article, the date of application, the date of registration, the date of renewal, the date of cancellation, if any, and, if yes, the number of times it has been renewed. : N.A.
17. Registrar : 
DEPUTY REGISTRAR OF COPYRIGHTS

Diary Number : 13902/2020-CO/L

Date of Application : 22/09/2020

Date of Receipt : 22/09/2020





Dated : 11/12/2020

1. Registration Number : **L-97555/2020**
2. Name, address and nationality of the applicant : KRISHNA INSTITUTE OF MEDICAL SCIENCES "DEEMED TO BE UNIVERSITY", NH4, PUNE - BANGALORE HIGHWAY, DIST. SATARA, AGASHIVNAGAR, MALKAPUR, MAHARASHTRA-415539
INDIAN
3. Nature of the applicant's interest in the copyright of the work : OWNER
4. Class and description of the work : LITERARY/ DRAMATIC WORK
5. Title of the work : PULPOTOMY OF PRIMARY TEETH [CONSENT FORM]
6. Language of the work : ENGLISH
7. Name, address and nationality of the author and if the author is deceased, date of his decease : DR. PRERNA BARGE, KRISHNA INSTITUTE OF MEDICAL SCIENCES "DEEMED TO BE UNIVERSITY", NH4, PUNE - BANGALORE HIGHWAY, DIST. SATARA, AGASHIVNAGAR, MALKAPUR, MAHARASHTRA-415539
INDIAN

DR. SHASHIKIRAN ND, KRISHNA INSTITUTE OF MEDICAL SCIENCES "DEEMED TO BE UNIVERSITY", NH4, PUNE - BANGALORE HIGHWAY, DIST. SATARA, AGASHIVNAGAR, MALKAPUR, MAHARASHTRA-415539
INDIAN

DR. SACHIN GUGAWAD, KRISHNA INSTITUTE OF MEDICAL SCIENCES "DEEMED TO BE UNIVERSITY", NH4, PUNE - BANGALORE HIGHWAY, DIST. SATARA, AGASHIVNAGAR, MALKAPUR, MAHARASHTRA-415539
INDIAN
8. Whether the work is published or unpublished : UNPUBLISHED
9. Year and country of first publication and name, address and nationality of the publisher : N.A.
10. Years and countries of subsequent publications, if any, and names, addresses and nationalities of the publishers : N.A.
11. Names, addresses and nationalities of the owners of various rights comprising the copyright in the work and the extent of rights held by each, together with particulars of assignments and licences, if any : KRISHNA INSTITUTE OF MEDICAL SCIENCES "DEEMED TO BE UNIVERSITY", NH4, PUNE - BANGALORE HIGHWAY, DIST. SATARA, AGASHIVNAGAR, MALKAPUR, MAHARASHTRA-415539
INDIAN
12. Names, addresses and nationalities of other persons, if any, authorised to assign or licence of rights comprising the copyright : KRISHNA INSTITUTE OF MEDICAL SCIENCES "DEEMED TO BE UNIVERSITY", NH4, PUNE - BANGALORE HIGHWAY, DIST. SATARA, AGASHIVNAGAR, MALKAPUR, MAHARASHTRA-415539
INDIAN
13. If the work is an 'Artistic work', the location of the original work, including name, address and nationality of the person in possession of the work. (In the case of an architectural work, the year of completion of the work should also be shown). : N.A.
14. If the work is an 'Artistic work' which is used or capable of being used in relation to any goods or services, the application should include a certification from the Registrar of Trade Marks in terms of the provisions of Sub-Section (i) of Section 45 of the Copyright Act, 1957. : N.A.
15. If the work is an 'Artistic work', whether it is registered under the provisions of the Copyright Act, 1957, give details. : N.A.
16. If the work is an 'Artistic work', capable of being registered as a trademark under the Trademarks Act 2000, whether it has been applied to an industrial process and, if yes, the number of times : N.A.
17. Remarks : 

DEPUTY REGISTRAR OF COPYRIGHTS

Diary Number : 13917/2020-CO/L
Date of Application : 22/09/2020
Date of Receipt : 22/09/2020



Dated : 09/12/2020

- | | | |
|---|---|---|
| 1. Registration Number | : | L-97356/2020 |
| 2. Name, address and nationality of the applicant | : | KRISHNA INSTITUTE OF MEDICAL SCIENCES "DEEMED TO BE UNIVERSITY", NH4, PUNE - BANGALORE HIGHWAY, DIST. SATARA, AGASHIVNAGAR, MALKAPUR, MAHARASHTRA-415539
INDIAN |
| 3. Nature of the applicant's interest in the copyright of the work | : | OWNER |
| 4. Class and description of the work | : | LITERARY/ DRAMATIC WORK |
| 5. Title of the work | : | ROOT CANAL THERAPY OF PERMANENT TEETH IN CHILD [CONSENT FORM] |
| 6. Language of the work | : | ENGLISH |
| 7. Name, address and nationality of the author and if the author is deceased, date of his decease | : | DR. PRERNA BARGE, KRISHNA INSTITUTE OF MEDICAL SCIENCES "DEEMED TO BE UNIVERSITY NH4, PUNE - BANGALORE HIGHWAY, DIST. SATARA, AGASHIVNAGAR, MALKAPUR, MAHARASHTRA-415539
INDIAN

DR. SHASHIKIRAN ND, KRISHNA INSTITUTE OF MEDICAL SCIENCES "DEEMED TO BE UNIVERSITY NH4, PUNE - BANGALORE HIGHWAY, DIST. SATARA, AGASHIVNAGAR, MALKAPUR, MAHARASHTRA-415539
INDIAN

DR. NAMRATA GAONKAR, KRISHNA INSTITUTE OF MEDICAL SCIENCES "DEEMED TO BE UNIVERSITY NH4, PUNE - BANGALORE HIGHWAY, DIST. SATARA, AGASHIVNAGAR, MALKAPUR, MAHARASHTRA-415539
INDIAN |
| 8. Whether the work is published or unpublished | : | UNPUBLISHED |
| 9. Year and country of first publication and name, address and nationality of the publisher | : | N.A. |
| 10. Years and countries of subsequent publications, if any, and names, addresses and nationalities of the publishers | : | N.A. |
| 11. Names, addresses and nationalities of the owners of various rights comprising the copyright in the work and the extent of rights held by each, together with particulars of assignments and licences, if any | : | KRISHNA INSTITUTE OF MEDICAL SCIENCES "DEEMED TO BE UNIVERSITY", NH4, PUNE - BANGALORE HIGHWAY, DIST. SATARA, AGASHIVNAGAR, MALKAPUR, MAHARASHTRA-415539
INDIAN |
| 12. Names, addresses and nationalities of other persons, if any, authorised to assign or licence of rights comprising the copyright | : | KRISHNA INSTITUTE OF MEDICAL SCIENCES "DEEMED TO BE UNIVERSITY", NH4, PUNE - BANGALORE HIGHWAY, DIST. SATARA, AGASHIVNAGAR, MALKAPUR, MAHARASHTRA-415539
INDIAN |
| 13. If the work is an 'Artistic work', the location of the original work, including name, address and nationality of the person in possession of the work. (In the case of an architectural work, the year of completion of the work should also be shown). | : | N.A. |
| 14. If the work is an 'Artistic work' which is used or capable of being used in relation to any goods or services, the application should include notification from the Registrar of Trade Marks in terms of the said Section (i) of Section 45 of the Copyright Act, | : | N.A. |
| 15. If the work is an 'Artistic work', whether it is registered under the Copyright Act, 1957, give details. | : | N.A. |
| 16. If the work is an 'Artistic work', capable of being registered as a trademark under the Trademarks Act 2000, whether it has been applied to an industrial process and, if yes, the number of times it has been so applied. | : | N.A. |
| 17. Remarks, if any | : | |

Diary Number : 14142/2020-CO/L

Date of Application : 24/09/2020

Date of Receipt : 24/09/2020



DEPUTY REGISTRAR OF COPYRIGHTS



Dated : 09/12/2020

1. Registration Number : **L-97357/2020**
2. Name, address and nationality of the applicant : KRISHNA INSTITUTE OF MEDICAL SCIENCES "DEEMED TO BE UNIVERSITY", NH4, PUNE - BANGALORE HIGHWAY, DIST. SATARA, AGASHIVNAGAR, MALKAPUR, MAHARASHTRA-415539
INDIAN
3. Nature of the applicant's interest in the copyright of the work : OWNER
4. Class and description of the work : LITERARY/ DRAMATIC WORK
5. Title of the work : EXTRACTION OF IMPACTED TOOTH - SURGICAL METHOD [CONSENT FORM]
6. Language of the work : ENGLISH
7. Name, address and nationality of the author and if the author is deceased, date of his decease : DR. PRERNA BARGE, KRISHNA INSTITUTE OF MEDICAL SCIENCES "DEEMED TO BE UNIVERSITY NH4, PUNE - BANGALORE HIGHWAY, DIST. SATARA, AGASHIVNAGAR, MALKAPUR, MAHARASHTRA-415539
INDIAN

DR. SHASHIKIRAN ND, KRISHNA INSTITUTE OF MEDICAL SCIENCES "DEEMED TO BE UNIVERSITY NH4, PUNE - BANGALORE HIGHWAY, DIST. SATARA, AGASHIVNAGAR, MALKAPUR, MAHARASHTRA-415539
INDIAN

DR. SWAPNIL TAUR, KRISHNA INSTITUTE OF MEDICAL SCIENCES "DEEMED TO BE UNIVERSITY NH4, PUNE - BANGALORE HIGHWAY, DIST. SATARA, AGASHIVNAGAR, MALKAPUR, MAHARASHTRA-415539
INDIAN
8. Whether the work is published or unpublished : UNPUBLISHED
9. Year and country of first publication and name, address and nationality of the publisher : N.A.
10. Years and countries of subsequent publications, if any, and names, addresses and nationalities of the publishers : N.A.
11. Names, addresses and nationalities of the owners of various rights comprising the copyright in the work and the extent of rights held by each, together with particulars of assignments and licences, if any : KRISHNA INSTITUTE OF MEDICAL SCIENCES "DEEMED TO BE UNIVERSITY", NH4, PUNE - BANGALORE HIGHWAY, DIST. SATARA, AGASHIVNAGAR, MALKAPUR, MAHARASHTRA-415539
INDIAN
12. Names, addresses and nationalities of other persons, if any, authorised to assign or licence of rights comprising the copyright : KRISHNA INSTITUTE OF MEDICAL SCIENCES "DEEMED TO BE UNIVERSITY", NH4, PUNE - BANGALORE HIGHWAY, DIST. SATARA, AGASHIVNAGAR, MALKAPUR, MAHARASHTRA-415539
INDIAN
13. If the work is an 'Artistic work', the location of the original work, including name, address and nationality of the person in possession of the work. (In the case of an architectural work, the year of completion of the work should also be shown). : N.A.
14. If the work is an 'Artistic work' which is used or capable of being used in relation to any goods or services, the application should include a certification from the Registrar of Trade Marks in terms of the provisions of Sub-Section (i) of Section 45 of the Copyright Act, 1957. : N.A.
15. If the work is an 'Artistic work', whether it is registered under the provisions of the Trade Marks Act, 1999, give details. : N.A.
16. If the work is an 'Artistic work', capable of being registered as a trademark under the Trade Marks Act 2000, whether it has been applied to an article, the material process and, if yes, the number of times : N.A.
17. Remarks : 

DEPUTY REGISTRAR OF COPYRIGHTS

Diary Number : 14144/2020-CO/L
Date of Application : 24/09/2020
Date of Receipt : 24/09/2020



Dated : 14/12/2020

1. Registration Number : **L-97678/2020**
2. Name, address and nationality of the applicant : KRISHNA INSTITUTE OF MEDICAL SCIENCES "DEEMED TO BE UNIVERSITY", KARAD , KRISHNA INSTITUTE OF MEDICAL SCIENCES "DEEMED TO BE UNIVERSITY", KARAD, MALKAPUR, KARAD, DIST. SATARA, MAHARASHTRA, INDIA-415539
INDIAN
3. Nature of the applicant's interest in the copyright of the work : OWNER
4. Class and description of the work : LITERARY/ DRAMATIC WORK
5. Title of the work : PROCESS FLOW FOR HARD GELATIN CAPSULE SHELL MANUFACTURING PROCESS
6. Language of the work : ENGLISH
7. Name, address and nationality of the author and if the author is deceased, date of his decease : DR. ROHIT RAJENDRA BHOSALE , KRISHNA INSTITUTE OF MEDICAL SCIENCES "DEEMED TO BE UNIVERSITY", KARAD, MALKAPUR, KARAD, DIST. SATARA, MAHARASHTRA, INDIA-415539
INDIAN

DR. RAJENDRA C.DOIJAD , KRISHNA INSTITUTE OF MEDICAL SCIENCES "DEEMED TO BE UNIVERSITY", KARAD, MALKAPUR, KARAD, DIST. SATARA, MAHARASHTRA, INDIA-415539
INDIAN
8. Whether the work is published or unpublished : UNPUBLISHED
9. Year and country of first publication and name, address and nationality of the publisher : N.A.
10. Years and countries of subsequent publications, if any, and names, addresses and nationalities of the publishers : N.A.
11. Names, addresses and nationalities of the owners of various rights comprising the copyright in the work and the extent of rights held by each, together with particulars of assignments and licences, if any : KRISHNA INSTITUTE OF MEDICAL SCIENCES "DEEMED TO BE UNIVERSITY", KARAD , KRISHNA INSTITUTE OF MEDICAL SCIENCES "DEEMED TO BE UNIVERSITY", KARAD, MALKAPUR, KARAD, DIST. SATARA, MAHARASHTRA, INDIA-415539
INDIAN
12. Names, addresses and nationalities of other persons, if any, authorised to assign or licence of rights comprising the copyright : N.A.
13. If the work is an 'Artistic work', the location of the original work, including name, address and nationality of the person in possession of the work. (In the case of an architectural work, the year of completion of the work should also be shown). : N.A.
14. If the work is an 'Artistic work' which is used or capable of being used in relation to any goods or services, the application should include a certification from the Registrar of Trade Marks in terms of the provision to Sub-Section (i) of Section 45 of the Copyright Act, 1957. : N.A.
15. If the work is an 'Artistic work', whether it is registered under the Designs Act 2000 if yes give details. : N.A.
16. If the work is an 'Artistic work', capable of being registered as a design under the Designs Act 2000, whether it has been applied to an article, industrial process and ,if yes ,the number of times : N.A.
17. :



14413/2020-CO/L

28/09/2020

Date

28/09/2020

DEPUTY REGISTRAR OF COPYRIGHTS



Dated : 14/12/2020

1. Registration Number : **L-97676/2020**
2. Name, address and nationality of the applicant : KRISHNA INSTITUTE OF MEDICAL SCIENCES "DEEMED TO BE UNIVERSITY", KARAD , KRISHNA INSTITUTE OF MEDICAL SCIENCES "DEEMED TO BE UNIVERSITY", KARAD, MALKAPUR, KARAD, DIST. SATARA, MAHARASHTRA, INDIA-415539
INDIAN
3. Nature of the applicant's interest in the copyright of the work : OWNER
4. Class and description of the work : LITERARY/ DRAMATIC WORK
5. Title of the work : ONLINE SEMINAR ON CIRCUMSTANCES/CASES IN WHICH MEDICAL PRACTITIONERS REQUIRED TO GIVE OPINION REGARDING DETERMINATION OF AGE DURING COVID-19 PANDEMIC
6. Language of the work : ENGLISH
7. Name, address and nationality of the author and if the author is deceased, date of his decease : DR. CHANDRAKANT M KOKATANUR , KRISHNA INSTITUTE OF MEDICAL SCIENCES "DEEMED TO BE UNIVERSITY", KARAD, MALKAPUR, KARAD, DIST. SATARA, MAHARASHTRA, INDIA-415539
INDIAN

DR AJAY VINAYAK PATIL , KRISHNA INSTITUTE OF MEDICAL SCIENCES "DEEMED TO BE UNIVERSITY", KARAD, MALKAPUR, KARAD, DIST. SATARA, MAHARASHTRA, INDIA-415539
INDIAN

DR VINAY BANNUR , KRISHNA INSTITUTE OF MEDICAL SCIENCES "DEEMED TO BE UNIVERSITY", KARAD, MALKAPUR, KARAD, DIST. SATARA, MAHARASHTRA, INDIA-415539
INDIAN

MS SOUMYA JHA , KRISHNA INSTITUTE OF MEDICAL SCIENCES "DEEMED TO BE UNIVERSITY", KARAD, MALKAPUR, KARAD, DIST. SATARA, MAHARASHTRA, INDIA-415539
INDIAN
8. Whether the work is published or unpublished : UNPUBLISHED
9. Year and country of first publication and name, address and nationality of the publisher : N.A.
10. Years and countries of subsequent publications, if any, and names, addresses and nationalities of the publishers : N.A.
11. Names, addresses and nationalities of the owners of various rights comprising the copyright in the work and the extent of rights held by each, together with particulars of assignments and licences, if any : KRISHNA INSTITUTE OF MEDICAL SCIENCES "DEEMED TO BE UNIVERSITY", KARAD , KRISHNA INSTITUTE OF MEDICAL SCIENCES "DEEMED TO BE UNIVERSITY", KARAD, MALKAPUR, KARAD, DIST. SATARA, MAHARASHTRA, INDIA-415539
INDIAN
12. Names, addresses and nationalities of other persons, if any, authorised to assign or licence of rights comprising the copyright : N.A.
13. If the work is an 'Artistic work', the location of the original work, including the address and nationality of the person in possession of the work (in the case of an architectural work, the year of construction of the work should also be shown). : N.A.
14. If the work is an 'Artistic work' which is used or capable of being used as a trademark or service mark, the application should be made to the Registrar of Trade Marks in terms of section (i) of Section 45 of the Copyright Act, 1957 : N.A.
15. If the work is an 'Artistic work', whether it is registered under the Designs Act 2000 if yes give details. : N.A.
16. If the work is an 'Artistic work', capable of being registered as a design under the Designs Act 2000, whether it has been applied to an article through an industrial process and, if yes, the number of times it is reproduced. : N.A.
17. Remarks, if any :



DEPUTY REGISTRAR OF COPYRIGHTS

Diary Number : 14418/2020-CO/L
Date of Application : 28/09/2020
Date of Receipt : 28/09/2020



A handwritten signature in blue ink, appearing to read "Munira", is written over a grid of small dots.

DEPUTY REGISTRAR OF COPYRIGHTS



Dated : 14/12/2020

1. Registration Number : **L-97707/2020**
2. Name, address and nationality of the applicant : KRISHNA INSTITUTE OF MEDICAL SCIENCES "DEEMED TO BE UNIVERSITY", KARAD , KRISHNA INSTITUTE OF MEDICAL SCIENCES "DEEMED TO BE UNIVERSITY", KARAD, MALKAPUR, KARAD, DIST. SATARA, MAHARASHTRA, INDIA-415539
INDIAN
3. Nature of the applicant's interest in the copyright of the work : OWNER
4. Class and description of the work : LITERARY/ DRAMATIC WORK
5. Title of the work : ONLINE SEMINAR ON DENTAL FINDINGS IN EARLY AGE ESTIMATION DURING COVID-19 PANDEMIC
6. Language of the work : ENGLISH
7. Name, address and nationality of the author and if the author is deceased, date of his decease : DR. CHANDRAKANT M KOKATANUR , KRISHNA INSTITUTE OF MEDICAL SCIENCES "DEEMED TO BE UNIVERSITY", KARAD, MALKAPUR, KARAD, DIST. SATARA, MAHARASHTRA, INDIA-415539
INDIAN

DR AJAY VINAYAK PATIL , KRISHNA INSTITUTE OF MEDICAL SCIENCES "DEEMED TO BE UNIVERSITY", KARAD, MALKAPUR, KARAD, DIST. SATARA, MAHARASHTRA, INDIA-415539
INDIAN

DR VINAY BANNUR , KRISHNA INSTITUTE OF MEDICAL SCIENCES "DEEMED TO BE UNIVERSITY", KARAD, MALKAPUR, KARAD, DIST. SATARA, MAHARASHTRA, INDIA-415539
INDIAN

MS SRISHTI SINHA , KRISHNA INSTITUTE OF MEDICAL SCIENCES "DEEMED TO BE UNIVERSITY", KARAD, MALKAPUR, KARAD, DIST. SATARA, MAHARASHTRA, INDIA-415539
INDIAN
8. Whether the work is published or unpublished : UNPUBLISHED
9. Year and country of first publication and name, address and nationality of the publisher : N.A.
10. Years and countries of subsequent publications, if any, and names, addresses and nationalities of the publishers : N.A.
11. Names, addresses and nationalities of the owners of various rights comprising the copyright in the work and the extent of rights held by each, together with particulars of assignments and licences, if any : KRISHNA INSTITUTE OF MEDICAL SCIENCES "DEEMED TO BE UNIVERSITY", KARAD , KRISHNA INSTITUTE OF MEDICAL SCIENCES "DEEMED TO BE UNIVERSITY", KARAD, MALKAPUR, KARAD, DIST. SATARA, MAHARASHTRA, INDIA-415539
INDIAN
12. Names, addresses and nationalities of other persons, if any, authorised to assign or licence of rights comprising the copyright : N.A.
13. If the work is an 'Artistic work', the location of the original work, including name, address and nationality of the person in possession of the work. (In the case of an architectural work, the year of completion of the work should also be shown). : N.A.
14. If the work is an 'Artistic work' which is used or capable of being used in connection with goods or services, the application should be made to the Registrar of Trade Marks in terms of Section (i) of Section 45 of the Copyright Act, : N.A.
15. If the work is an 'Artistic work', whether it is registered under the Designs Act 2000, give details. : N.A.
16. If the work is an 'Artistic work', capable of being registered as a design under the Designs Act 2000, whether it has been applied to an article though an industrial process and, if yes, the number of times it is reproduced. : N.A.
17. Remarks, if any :



DEPUTY REGISTRAR OF COPYRIGHTS

Date of Application :

28/09/2020

Date of Receipt :

28/09/2020



A handwritten signature in blue ink, appearing to read "Munira", is written over a grid of small dots.

DEPUTY REGISTRAR OF COPYRIGHTS



Dated : 16/12/2020

1. Registration Number : **L-97814/2020**
2. Name, address and nationality of the applicant : KRISHNA INSTITUTE OF MEDICAL SCIENCES "DEEMED TO BE UNIVERSITY", KARAD , KRISHNA INSTITUTE OF MEDICAL SCIENCES "DEEMED TO BE UNIVERSITY", KARAD, MALKAPUR, KARAD, DIST. SATARA, MAHARASHTRA, INDIA-415539 INDIAN
3. Nature of the applicant's interest in the copyright of the work : OWNER
4. Class and description of the work : LITERARY/ DRAMATIC WORK
5. Title of the work : YOGIDENT- A COMPREHENSIVE YOGA MODULE FOR DENTAL PROFESSIONALS
6. Language of the work : ENGLISH
7. Name, address and nationality of the author and if the author is deceased, date of his decease : DR. SAMEER ANIL ZOPE , KRISHNA INSTITUTE OF MEDICAL SCIENCES "DEEMED TO BE UNIVERSITY", KARAD, MALKAPUR, KARAD, DIST. SATARA, MAHARASHTRA, INDIA-415539 INDIAN
DR. GIRISH SURAGIMATH , KRISHNA INSTITUTE OF MEDICAL SCIENCES "DEEMED TO BE UNIVERSITY", KARAD, MALKAPUR, KARAD, DIST. SATARA, MAHARASHTRA, INDIA-415539 INDIAN
DR. SIDDHARTHA VARMA , KRISHNA INSTITUTE OF MEDICAL SCIENCES "DEEMED TO BE UNIVERSITY", KARAD, MALKAPUR, KARAD, DIST. SATARA, MAHARASHTRA, INDIA-415539 INDIAN
8. Whether the work is published or unpublished : UNPUBLISHED
9. Year and country of first publication and name, address and nationality of the publisher : N.A.
10. Years and countries of subsequent publications, if any, and names, addresses and nationalities of the publishers : N.A.
11. Names, addresses and nationalities of the owners of various rights comprising the copyright in the work and the extent of rights held by each, together with particulars of assignments and licences, if any : KRISHNA INSTITUTE OF MEDICAL SCIENCES "DEEMED TO BE UNIVERSITY", KARAD , KRISHNA INSTITUTE OF MEDICAL SCIENCES "DEEMED TO BE UNIVERSITY", KARAD, MALKAPUR, KARAD, DIST. SATARA, MAHARASHTRA, INDIA-415539 INDIAN
12. Names, addresses and nationalities of other persons, if any, authorised to assign or licence of rights comprising the copyright : N.A.
13. If the work is an 'Artistic work', the location of the original work, including name, address and nationality of the person in possession of the work. (In the case of an architectural work, the year of completion of the work should also be shown). : N.A.
14. If the work is an 'Artistic work' which is used or capable of being used in relation to any goods or services, the application should include a certification from the Registrar of Trade Marks in terms of the provision to Sub-Section (i) of Section 45 of the Copyright Act, 1957. : N.A.
15. If the work is an 'Artistic work', whether it is registered under the Copyright Act, 1957, give details. : N.A.
16. If the work is an 'Artistic work', capable of being registered as a work under the Copyright Act 2000, whether it has been applied to an industrial process and ,if yes ,the number of times : N.A.
17. Registrar : **DEPUTY REGISTRAR OF COPYRIGHTS**

Diary Number : 14918/2020-CO/L
Date of Application : 05/10/2020
Date of Receipt : 05/10/2020





Dated : 16/12/2020

1. Registration Number : **L-97819/2020**
2. Name, address and nationality of the applicant : KRISHNA INSTITUTE OF MEDICAL SCIENCES“DEEMED TO BE UNIVERSITY , NH4,PUNE -BANGALORE HIGHWAY, DIST. SATARA, AGASHIVNAGAR, MALKAPUR, MAHARASHTRA-415539 INDIAN
3. Nature of the applicant's interest in the copyright of the work : OWNER
4. Class and description of the work : LITERARY/ DRAMATIC WORK
5. Title of the work : MENTORSHIP SYSTEM FOR STUDENTS
6. Language of the work : ENGLISH
7. Name, address and nationality of the author and if the author is deceased, date of his decease : DR. RAJENDRA C. DOJJAD , NH4,PUNE -BANGALORE HIGHWAY, DIST. SATARA, AGASHIVNAGAR, MALKAPUR, MAHARASHTRA-415539 INDIAN
8. Whether the work is published or unpublished : UNPUBLISHED
9. Year and country of first publication and name, address and nationality of the publisher : N.A.
10. Years and countries of subsequent publications, if any, and names, addresses and nationalities of the publishers : N.A.
11. Names, addresses and nationalities of the owners of various rights comprising the copyright in the work and the extent of rights held by each, together with particulars of assignments and licences, if any : KRISHNA INSTITUTE OF MEDICAL SCIENCES“DEEMED TO BE UNIVERSITY , NH4,PUNE -BANGALORE HIGHWAY, DIST. SATARA, AGASHIVNAGAR, MALKAPUR, MAHARASHTRA-415539 INDIAN
12. Names, addresses and nationalities of other persons, if any, authorised to assign or licence of rights comprising the copyright : KRISHNA INSTITUTE OF MEDICAL SCIENCES“DEEMED TO BE UNIVERSITY , NH4,PUNE -BANGALORE HIGHWAY, DIST. SATARA, AGASHIVNAGAR, MALKAPUR, MAHARASHTRA-415539 INDIAN
13. If the work is an 'Artistic work', the location of the original work, including name, address and nationality of the person in possession of the work. (In the case of an architectural work, the year of completion of the work should also be shown). : N.A.
14. If the work is an 'Artistic work' which is used or capable of being used in relation to any goods or services, the application should include a certification from the Registrar of Trade Marks in terms of the provision to Sub-Section (i) of Section 45 of the Copyright Act, 1957. : N.A.
15. If the work is an 'Artistic work', whether it is registered under the Designs Act 2000 if yes give details. : N.A.
16. If the work is an 'Artistic work', capable of being registered as a design under the Designs Act 2000.whether it has been applied to an article though an industrial process and ,if yes ,the number of times it is reproduced. : N.A.
17. Remarks, if any :

Diary Number : 15319/2020-CO/L

Date : 08/10/2020

08/10/2020



DEPUTY REGISTRAR OF COPYRIGHTS



Dated : 16/12/2020

1. Registration Number : **L-97820/2020**
2. Name, address and nationality of the applicant : KRISHNA INSTITUTE OF MEDICAL SCIENCES "DEEMED TO BE UNIVERSITY", KARAD , KRISHNA INSTITUTE OF MEDICAL SCIENCES "DEEMED TO BE UNIVERSITY", KARAD, MALKAPUR, KARAD, DIST. SATARA, MAHARASHTRA, INDIA-415539
INDIAN
3. Nature of the applicant's interest in the copyright of the work : OWNER
4. Class and description of the work : LITERARY/ DRAMATIC WORK
5. Title of the work : CONCEPT OF SOOTHING MUSIC TO EASE STRESS AND ANXIETY IN DENTAL PATIENTS
6. Language of the work : ENGLISH
7. Name, address and nationality of the author and if the author is deceased, date of his decease : DR. RASHMI G GANGAVATI , KRISHNA INSTITUTE OF MEDICAL SCIENCES "DEEMED TO BE UNIVERSITY", KARAD, MALKAPUR, KARAD, DIST. SATARA, MAHARASHTRA, INDIA-415539
INDIAN

DR. SHASHIKIRAN N.D. , KRISHNA INSTITUTE OF MEDICAL SCIENCES "DEEMED TO BE UNIVERSITY", KARAD, MALKAPUR, KARAD, DIST. SATARA, MAHARASHTRA, INDIA-415539
INDIAN

DR. SIDDHARTHA VARMA , KRISHNA INSTITUTE OF MEDICAL SCIENCES "DEEMED TO BE UNIVERSITY", KARAD, MALKAPUR, KARAD, DIST. SATARA, MAHARASHTRA, INDIA-415539
INDIAN
8. Whether the work is published or unpublished : UNPUBLISHED
9. Year and country of first publication and name, address and nationality of the publisher : N.A.
10. Years and countries of subsequent publications, if any, and names, addresses and nationalities of the publishers : N.A.
11. Names, addresses and nationalities of the owners of various rights comprising the copyright in the work and the extent of rights held by each, together with particulars of assignments and licences, if any : KRISHNA INSTITUTE OF MEDICAL SCIENCES "DEEMED TO BE UNIVERSITY", KARAD , KRISHNA INSTITUTE OF MEDICAL SCIENCES "DEEMED TO BE UNIVERSITY", KARAD, MALKAPUR, KARAD, DIST. SATARA, MAHARASHTRA, INDIA-415539
INDIAN
12. Names, addresses and nationalities of other persons, if any, authorised to assign or licence of rights comprising the copyright : N.A.
13. If the work is an 'Artistic work', the location of the original work, including name, address and nationality of the person in possession of the work. (In the case of an architectural work, the year of completion of the work should also be shown). : N.A.
14. If the work is an 'Artistic work' which is used or capable of being used in relation to any goods or services, the application should include a certification from the Registrar of Trade Marks in terms of the provision to Sub-Section (i) of Section 45 of the Copyright Act, 1957. : N.A.
15. If the work is an 'Artistic work', whether it is registered under the Copyright Act, 1957, give details. : N.A.
16. If the work is an 'Artistic work', capable of being registered as a work under the Copyright Act 2000, whether it has been applied to an industrial process and, if yes, the number of times : N.A.
17. Registrar : 
DEPUTY REGISTRAR OF COPYRIGHTS

Diary Number : 15514/2020-CO/L
Date of Application : 10/10/2020
Date of Receipt : 10/10/2020





Dated : 16/12/2020

1. Registration Number : **L-97821/2020**
2. Name, address and nationality of the applicant : KRISHNA INSTITUTE OF MEDICAL SCIENCES DEEMED TO BE UNIVERSITY, KARAD, MAHARASHTRA , KRISHNA INSTITUTE OF MEDICAL SCIENCES "DEEMED TO BE UNIVERSITY" NEAR DHEBEWADI ROAD, MALKAPUR, TAL-KARAD, DIST: SATARA, MAHARASHTRA, INDIA-415539 INDIAN
3. Nature of the applicant's interest in the copyright of the work : OWNER
4. Class and description of the work : LITERARY/ DRAMATIC WORK
5. Title of the work : PREFERRED CHOICE OF COLOR IN TYPICAL AND ATYPICAL CHILDREN
6. Language of the work : ENGLISH
7. Name, address and nationality of the author and if the author is deceased, date of his decease : DR. KIRAN KAMBLE , MPT STUDENT, FAULTY OF PHYSIOTHERAPY, KRISHNA INSTITUTE OF MEDICAL SCIENCES DEEMED TO BE UNIVERSITY, KARAD-415539 INDIAN
DR. SMITA CHANDRAKANT PATIL , ASSISTANT PROFESSOR, DEPARTMENT OF MUSCULOSKELETAL SCIENCES, FACULTY OF PHYSIOTHERAPY, KIMSDU, KARAD, MAHARASHTRA, INDIA-415539 INDIAN
8. Whether the work is published or unpublished : UNPUBLISHED
9. Year and country of first publication and name, address and nationality of the publisher : N.A.
10. Years and countries of subsequent publications, if any, and names, addresses and nationalities of the publishers : N.A.
11. Names, addresses and nationalities of the owners of various rights comprising the copyright in the work and the extent of rights held by each, together with particulars of assignments and licences, if any : KRISHNA INSTITUTE OF MEDICAL SCIENCES DEEMED TO BE UNIVERSITY, KARAD, MAHARASHTRA , KRISHNA INSTITUTE OF MEDICAL SCIENCES "DEEMED TO BE UNIVERSITY" NEAR DHEBEWADI ROAD, MALKAPUR, TAL-KARAD, DIST: SATARA, MAHARASHTRA, INDIA-415539 INDIAN
12. Names, addresses and nationalities of other persons, if any, authorised to assign or licence of rights comprising the copyright : N.A.
13. If the work is an 'Artistic work', the location of the original work, including name, address and nationality of the person in possession of the work. (In the case of an architectural work, the year of completion of the work should also be shown). : N.A.
14. If the work is an 'Artistic work' which is used or capable of being used in relation to any goods or services, the application should include a certification from the Registrar of Trade Marks in terms of the provision to Sub-Section (i) of Section 45 of the Copyright Act, 1957. : N.A.
15. If the work is an 'Artistic work', whether it is registered under the Designs Act 2000 if yes give details. : N.A.
16. If the work is an 'Artistic work', capable of being registered as a design under the Designs Act 2000, whether it has been applied to an article, if yes, the number of times : N.A.
17. :



15525/2020-CO/L

10/10/2020

Date of registration : 10/10/2020

DEPUTY REGISTRAR OF COPYRIGHTS



Dated : 08/12/2020

1. Registration Number : **L-97270/2020**
2. Name, address and nationality of the applicant : KRISHNA INSTITUTE OF MEDICAL SCIENCES "DEEMED TO BE UNIVERSITY", KARAD , KRISHNA INSTITUTE OF MEDICAL SCIENCES "DEEMED TO BE UNIVERSITY", KARAD, MALKAPUR, KARAD, DIST. SATARA, MAHARASHTRA, INDIA-415539
INDIAN
3. Nature of the applicant's interest in the copyright of the work : OWNER
4. Class and description of the work : LITERARY/ DRAMATIC WORK FORENSIC MEDICINE
INTERNAL THEORY EXAMINATION
5. Title of the work : FORENSIC MEDICINE INTERNAL THEORY EXAMINATION
BY E-QUESTION PAPER USING POWERPOINT
6. Language of the work : ENGLISH
7. Name, address and nationality of the author and if the author is deceased, date of his decease : DR. CHANDRAKANT M KOKATANUR , KRISHNA INSTITUTE OF MEDICAL SCIENCES "DEEMED TO BE UNIVERSITY", KARAD, MALKAPUR, KARAD, DIST. SATARA, MAHARASHTRA, INDIA-415539
INDIAN

DR. AJAY VINAYAK PATIL , KRISHNA INSTITUTE OF MEDICAL SCIENCES "DEEMED TO BE UNIVERSITY", KARAD, MALKAPUR, KARAD, DIST. SATARA, MAHARASHTRA, INDIA-415539
INDIAN

DR. VINAY BANNUR , KRISHNA INSTITUTE OF MEDICAL SCIENCES "DEEMED TO BE UNIVERSITY", KARAD, MALKAPUR, KARAD, DIST. SATARA, MAHARASHTRA, INDIA-415539
INDIAN
8. Whether the work is published or unpublished : UNPUBLISHED
9. Year and country of first publication and name, address and nationality of the publisher : N.A.
10. Years and countries of subsequent publications, if any, and names, addresses and nationalities of the publishers : N.A.
11. Names, addresses and nationalities of the owners of various rights comprising the copyright in the work and the extent of rights held by each, together with particulars of assignments and licences, if any : KRISHNA INSTITUTE OF MEDICAL SCIENCES "DEEMED TO BE UNIVERSITY", KARAD , KRISHNA INSTITUTE OF MEDICAL SCIENCES "DEEMED TO BE UNIVERSITY", KARAD, MALKAPUR, KARAD, DIST. SATARA, MAHARASHTRA, INDIA-415539
INDIAN
12. Names, addresses and nationalities of other persons, if any, authorised to assign or licence of rights comprising the copyright : N.A.
13. If the work is an 'Artistic work', the location of the original work, including name, address and nationality of the person in possession of the work. (In the case of an architectural work, the year of completion of the work should also be shown). : N.A.
14. If the work is an 'Artistic work' which is used or capable of being used in relation to any goods or services, the application should include a certification from the Registrar of Trade Marks in terms of the provisions of Sub-Section (i) of Section 45 of the Copyright Act, 1957 : N.A.
15. If the work is an 'Artistic work', whether it is registered under the provisions of the Copyright Act, 1957, give details. : N.A.
16. If the work is an 'Artistic work', capable of being registered as a trademark under the provisions of the Trademarks Act 2000, whether it has been applied to an article, or is in the process of being so applied, if yes, the number of times it has been so applied : N.A.
17. Remarks :

Diary Number : 15529/2020-CO/L
Date of Application : 10/10/2020
Date of Receipt : 10/10/2020

DEPUTY REGISTRAR OF COPYRIGHTS



Dated : 16/12/2020

1. Registration Number : **L-97823/2020**
2. Name, address and nationality of the applicant : KRISHNA INSTITUTE OF MEDICAL SCIENCES DEEMED TO BE UNIVERSITY, KARAD, MAHARASHTRA , KRISHNA INSTITUTE OF MEDICAL SCIENCES "DEEMED TO BE UNIVERSITY" NEAR DHEBEWADI ROAD, MALKAPUR, TAL-KARAD, DIST: SATARA, MAHARASHTRA, INDIA,- 415539
INDIAN
3. Nature of the applicant's interest in the copyright of the work : OWNER
4. Class and description of the work : LITERARY/ DRAMATIC WORK
5. Title of the work : PHYSIYOGA SHIELD AGAINST COVID 19 FOR THE HIGHRISK POPULATION
6. Language of the work : ENGLISH
7. Name, address and nationality of the author and if the author is deceased, date of his decease : DR.PRASANNAJEET PRAMOD NIKAM , ASSISTANT PROFESSOR ; KRISHNA COLLEGE OF PHYSIOTHERAPY, KARAD; DEPARTMENT OF SPORTS PHYSIOTHERAPY; KRISHNA INSTITUTE OF MEDICAL SCIENCES DEEMED TO BE UNIVERSITY, KARAD, MAHARASHTRA, INDIA-415539
INDIAN

DR.G.VARADHARAJULU , DEAN; FACULTY OF PHYSIOTHERAPY; KRISHNA COLLEGE OF PHYSIOTHERAPY, KARAD; DEPARTMENT OF NEUROSCIENCES; KRISHNA INSTITUTE OF MEDICAL SCIENCES DEEMED TO BE UNIVERSITY, KARAD, MAHARASHTRA, INDIA-415539
INDIAN
8. Whether the work is published or unpublished : UNPUBLISHED
9. Year and country of first publication and name, address and nationality of the publisher : N.A.
10. Years and countries of subsequent publications, if any, and names, addresses and nationalities of the publishers : N.A.
11. Names, addresses and nationalities of the owners of various rights comprising the copyright in the work and the extent of rights held by each, together with particulars of assignments and licences, if any : KRISHNA INSTITUTE OF MEDICAL SCIENCES DEEMED TO BE UNIVERSITY, KARAD, MAHARASHTRA , KRISHNA INSTITUTE OF MEDICAL SCIENCES "DEEMED TO BE UNIVERSITY" NEAR DHEBEWADI ROAD, MALKAPUR, TAL-KARAD, DIST: SATARA, MAHARASHTRA, INDIA,- 415539
INDIAN
12. Names, addresses and nationalities of other persons, if any, authorised to assign or licence of rights comprising the copyright : N.A.
13. If the work is an 'Artistic work', the location of the original work, including name, address and nationality of the person in possession of the work. (In the case of an architectural work, the year of completion of the work should also be shown). : N.A.
14. If the work is an 'Artistic work' which is used or capable of being used in relation to any goods or services, the application should include a certification from the Registrar of Trade Marks in terms of the provision to Sub-Section (i) of Section 45 of the Copyright Act, 1957. : N.A.
15. If the work is an 'Artistic work', whether it is registered under the Copyright Act, 1957, give details. : N.A.
16. If the work is an 'Artistic work', capable of being registered as a trademark under the Trademarks Act 2000, whether it has been applied to an article, the date of application, the date of registration, if any, and the date of the process and ,if yes ,the number of times : N.A.
17. If the work is an 'Artistic work', whether it is registered under the Copyright Act, 1957, give details. : N.A.





DEPUTY REGISTRAR OF COPYRIGHTS

Diary : 15535/2020-CO/L

Date of Application : 10/10/2020

Date of Receipt : 10/10/2020



Dated : 22/12/2020

1. Registration Number : **L-97894/2020**
2. Name, address and nationality of the applicant : KRISHNA INSTITUTE OF MEDICAL SCIENCES "DEEMED TO BE UNIVERSITY , NH4,PUNE -BANGALORE HIGHWAY, DIST.SATARA,AGASHIVNAGAR, MALKAPUR, MAHARASHTRA-415539
INDIAN
3. Nature of the applicant's interest in the copyright of the work : OWNER
4. Class and description of the work : LITERARY/ DRAMATIC WORK
5. Title of the work : TREE PLANTATION BY CLASS TOPPERS
6. Language of the work : ENGLISH
7. Name, address and nationality of the author and if the author is deceased, date of his decease : DR. NAMRATA GAONKAR , NH4,PUNE -BANGALORE HIGHWAY, DIST.SATARA,AGASHIVNAGAR, MALKAPUR, MAHARASHTRA-415539
INDIAN

DR. SHASHI KIRAN. N.D , NH4,PUNE -BANGALORE HIGHWAY, DIST.SATARA,AGASHIVNAGAR, MALKAPUR, MAHARASHTRA-415539
INDIAN

DR. PRASHANT PUNDE , NH4,PUNE -BANGALORE HIGHWAY, DIST.SATARA,AGASHIVNAGAR, MALKAPUR, MAHARASHTRA-415539
INDIAN
8. Whether the work is published or unpublished : UNPUBLISHED
9. Year and country of first publication and name, address and nationality of the publisher : N.A.
10. Years and countries of subsequent publications, if any, and names, addresses and nationalities of the publishers : N.A.
11. Names, addresses and nationalities of the owners of various rights comprising the copyright in the work and the extent of rights held by each, together with particulars of assignments and licences, if any : KRISHNA INSTITUTE OF MEDICAL SCIENCES "DEEMED TO BE UNIVERSITY , NH4,PUNE -BANGALORE HIGHWAY, DIST.SATARA,AGASHIVNAGAR, MALKAPUR, MAHARASHTRA-415539
INDIAN
12. Names, addresses and nationalities of other persons, if any, authorised to assign or licence of rights comprising the copyright : KRISHNA INSTITUTE OF MEDICAL SCIENCES "DEEMED TO BE UNIVERSITY , NH4,PUNE -BANGALORE HIGHWAY, DIST.SATARA,AGASHIVNAGAR, MALKAPUR, MAHARASHTRA-415539
INDIAN
13. If the work is an 'Artistic work', the location of the original work, including name, address and nationality of the person in possession of the work. (In the case of an architectural work, the year of completion of the work should also be shown). : N.A.
14. If the work is an 'Artistic work' which is used or capable of being used in relation to any goods or services, the application should include a certification from the Registrar of Trade Marks in terms of the provision to Sub-Section (i) of Section 45 of the Copyright Act, 1957. : N.A.
15. If the work is an 'Artistic work', whether it is registered under the Designs Act 2000 if yes give details. : N.A.
16. If the work is an 'Artistic work', capable of being registered as a design under the Designs Act 2000, whether it has been applied to an article, the date of application, the date of registration, the date of publication and, if yes, the number of times : N.A.
17. :



18367/2020-CO/L

Date of Application : 12/11/2020

Date of Receipt : 12/11/2020

DEPUTY REGISTRAR OF COPYRIGHTS



Dated : 30/12/2020

1. Registration Number : **L-98052/2020**
2. Name, address and nationality of the applicant : KRISHNA INSTITUTE OF MEDICAL SCIENCES DEEMED TO BE UNIVERSITY, KARAD, MAHARASHTRA , KRISHNA INSTITUTE OF MEDICAL SCIENCES "DEEMED TO BE UNIVERSITY" NEAR DHEBEWADI ROAD, MALKAPUR, TAL-KARAD, DIST: SATARA, MAHARASHTRA, INDIA-415539 INDIAN
3. Nature of the applicant's interest in the copyright of the work : OWNER
4. Class and description of the work : LITERARY/ DRAMATIC WORK PATIENT COVID19 VULNERABILITY RISK ASSESSMENT SCALE ON PCVRAS19
5. Title of the work : PATIENT'S COVID-19 VULNERABILITY RISK ASSESSMENT SCALE (PCVRAS-19)
6. Language of the work : ENGLISH
7. Name, address and nationality of the author and if the author is deceased, date of his decease : DR.PRASANNAJEET PRAMOD NIKAM , ASSISTANT PROFESSOR ; KRISHNA COLLEGE OF PHYSIOTHERAPY, KARAD; DEPARTMENT OF SPORTS PHYSIOTHERAPY; KRISHNA INSTITUTE OF MEDICAL SCIENCES DEEMED TO BE UNIVERSITY, KARAD, MAHARASHTRA, INDIA.-415539 INDIAN
DR.G.VARADHARAJULU , DEAN; FACULTY OF PHYSIOTHERAPY; KRISHNA COLLEGE OF PHYSIOTHERAPY, KARAD; DEPARTMENT OF NEUROSCIENCES; KRISHNA INSTITUTE OF MEDICAL SCIENCES DEEMED TO BE UNIVERSITY, KARAD, MAHARASHTRA, INDIA-415539 INDIAN
8. Whether the work is published or unpublished : UNPUBLISHED
9. Year and country of first publication and name, address and nationality of the publisher : N.A.
10. Years and countries of subsequent publications, if any, and names, addresses and nationalities of the publishers : N.A.
11. Names, addresses and nationalities of the owners of various rights comprising the copyright in the work and the extent of rights held by each, together with particulars of assignments and licences, if any : KRISHNA INSTITUTE OF MEDICAL SCIENCES DEEMED TO BE UNIVERSITY, KARAD, MAHARASHTRA , KRISHNA INSTITUTE OF MEDICAL SCIENCES "DEEMED TO BE UNIVERSITY" NEAR DHEBEWADI ROAD, MALKAPUR, TAL-KARAD, DIST: SATARA, MAHARASHTRA, INDIA-415539 INDIAN
12. Names, addresses and nationalities of other persons, if any, authorised to assign or licence of rights comprising the copyright : N.A.
13. If the work is an 'Artistic work', the location of the original work, including name, address and nationality of the person in possession of the work. (In the case of an architectural work, the year of completion of the work should also be shown). : N.A.
14. If the work is an 'Artistic work' which is used or capable of being used in relation to any goods or services, the application should include a certification from the Registrar of Trade Marks in terms of the provision to Sub-Section (i) of Section 45 of the Copyright Act, 1957. : N.A.
15. If the work is an 'Artistic work', whether it is registered under the Copyright Act, 1957, give details. : N.A.
16. If the work is an 'Artistic work', capable of being registered as a work under the Copyright Act 2000, whether it has been applied to an industrial process and ,if yes ,the number of times : N.A.
17. Registrar : 
DEPUTY REGISTRAR OF COPYRIGHTS

Diary Number : 19367/2020-CO/L

Date of Application : 28/11/2020

Date of Receipt : 28/11/2020

