

# TECHNOLOGY TRANSFER DOCUMENTS



Add. Director of Research  
KIMSDU, Karad

**3.4.3.D. Number of technology-transferred during the last five years**

<b>Sr. No.</b>	<b>Name of the Patenter</b>	<b>Patent grant number/design application number</b>	<b>Title of the patent</b>	<b>Year for technology-transferred</b>
1	Applicant: Krishna Institute of Medical Sciences Inventors: Asha Pratinidhi, Arvind Kanhere, Aditya Pratinidhi	323819	Simulation Training Device for Assessment of the Cervical Dilatation	2019
2	Applicant: Krishna Institute of Medical Sciences "Deemed to be University" Inventors: Devyani Moghe, Kashinath Sahoo	332628	An orthotic device for supporting a shoulder joint of a user	2019
3	Applicant & Inventor: Sameer Karpe	332801	Customised ankle foot orthotic device	2019
4	Applicant & Inventor: Sunita Tata	311016	A device for physically restraining movement	2020
5	Applicant & Inventor: Rajashri Karale	314417	An injection guide	2020
6	Applicant & Inventors: Jayant Rajaram Pawar, D. N. Sonawane, Kiran Dashrath Diwate, Geeta Satish Karande, Swapnil Devanand Awachar, D.K. Agrawal (product design applied)	336097-001, 336098-001	UV sterilizer sevak 360 (Disinfecting and sterilizing chamber, Disinfecting and sterilizing tray)	2020
7	Applicant & Inventors: Jayant Rajaram Pawar, Amit Choudhari, D.K. Agrawal, Manish Shinde, G. S. Karande (product design applied)	336758-001, 336759-001	Face-mask (Electrostatic Fabric Respiratory-Mask, Electrostatic Fabric Respiratory-Mask with filter (set) )	2020

## Transfer of Technology Agreement

This Transfer of Technology Agreement (hereinafter referred to as "ToT") is made at Krishna Institute of Medical Sciences "Deemed to be University" (KIMSDU), Karad for the transfer of technology entitled "Simulation Training Device for Assessment of the Cervical Dilatation" developed by KIMSDU, Karad. This Technology Transfer ("ToT") Agreement made and entered into on this 24<sup>th</sup> day of December, 2019.

### BETWEEN

**Krishna Institute of Medical Sciences** "Deemed to be University", Karad ("KIMSDU"), through the Registrar, hereinafter referred to as "First Party"

### AND

**GI India Automation and Systems Private Limited**, Pune through Proprietor Mr. Jay Kanhere, hereinafter referred to as "Second Party".

WHEREAS the KIMSDU is an recognized Medical "Deemed to be university", accredited by NAAC with A grade, an ISO 9001:2015 certified University and is accredited by various reputed National and International bodies, having education and research expertise in the field of medical, paramedical, nursing, pharmaceutical and allied sciences.

WHEREAS the GI India Automation and Systems Private Limited is involved in the manufacturing and marketing of biomedical products and an authorized registered company.

AND WHEREAS both the parties KIMSDU and GI India Automation and Systems Private Limited desire to spell out the terms and conditions in respect of this collaboration and to enter into a Technology Transfer (ToT) Agreement for that purpose.

### NOW IT IS AGREED BY AND BETWEEN THE PARTIES AS UNDER

#### 1. SCOPE/TERMS OF COLLABORATION

- 1.1. The ToT agreement entitled to provide all the technical details about product on as is where is basis in order to achieve smooth manufacturing practices (details given in patent literature).
- 1.2. The charges for authentication and certifications of the product from competent authority shall be paid by "First party".
- 1.3. The second party shall not alter or dilute the quality of product as per the specifications made under the document of ToT which has been authenticated and approved by competent authorities (Controller of Patent).
- 1.4. The first party shall not enter into the manufacturing or marketing of the product directly or indirectly.



Add. Director of Research  
KIMSDU, Karad

- 1.5. The first party shall grant the design details of ToT agreement to the second party after the signing of this ToT agreement.
- 1.6. Any kind of breach in the conditions which has been mentioned in this document shall amount to withdrawal of this agreement by First party.

## 2. INTELLECTUAL PROPERTY RIGHTS AND PUBLICATIONS (IF ANY)

- 2.1 Notwithstanding anything contained to the contrary, the entire rights, title and interest in any intellectual property including but not limited to patent and publications emerging out of the collaborative research to be carried out under this ToT ("IP") agreement, will be jointly owned by both the parties, if it is during the research and Development work.
- 2.2 The exclusive right of business and product development out of the patent, development will remain with both the parties and in case of second party after authenticity transferring for commercialization and licensing which shall be covered by separate agreement for royalty distribution.

## 3. CONFIDENTIALITY

- 3.1 The term "Confidential Information" shall mean any information disclosed by one party ("Discloser") to the other ("Receiver"), pursuant to this ToT agreement or otherwise, which is in written, graphic, machine readable or other tangible form and is marked as 'Confidential' or 'Proprietary' or in some other manner to indicate its confidential nature. Confidential information may also include oral information disclosed by one party to the other, pursuant to this ToT agreement, provided that such information is designated as Confidential at the time of disclosure and reduce to a written summary by the disclosing party, within 30 days after its oral disclosure, which is marked in a manner to indicate its confidential nature and delivered to the receiving party.
- 3.2 For the term of this ToT agreement, each party, shall treat as confidential all confidential information of the other party, shall not use such confidential information except as expressly set forth herein or otherwise authorized in writing, shall implement reasonable procedures to prohibit the disclosure, unauthorized duplication, misuse or removal of the other parties confidential information and shall not disclose such confidential information to any third party except as may be necessary and required in connection with the rights and obligations of such party under this ToT agreement. Without limiting the foregoing, each of the parties shall use at least the same procedures and degree of care which it uses to prevent the disclosure of its own confidential information of like importance to prevent the disclosure of confidential information disclosed to it by the other party under this ToT agreement.



Add. Director of Research,  
KIMSDU, Karad

**4.3 Confidential information shall not include the information which,**

- i) was generally known and available at the time it was disclosed or becomes generally known and available through no fault of the receiver, was known to the recipient of such information, without restriction, at the time of disclosure as shown by the files of the recipient in existence at the time of disclosure,
- ii) is disclosed with the prior written approval of the disclosure,
- iii) was independently developed by the receiver without any use of the confidential information, and by employees and other agents of the receiver who have not been exposed to the confidential information, provided that the receiver can demonstrate such independent development by documented evidence prepared contemporaneously with such independent development.
- iv) becomes known to the receiver, without restriction, from a source other than the discloser without breach of this ToT agreement by the receiver and otherwise, not in violation of the discloser's rights.
- v) In addition, each party shall be entitled to disclose the other parties confidential information to the extent such disclosure is requested by the order or requirement of a Court, administrative agency, or other governmental body, provided that the party required to make the disclosure shall provide prompt and advance notice thereof, to enable the other party to seek a protective order or otherwise prevent such disclosure.

**5. RELATIONSHIP OF THE PARTIES**

Nothing in this ToT agreement is intended to create a partnership, joint venture or other form of relationship between the Parties. Neither party makes any representations or warranties, whether express or implied. Neither party shall be liable to other for any indirect, consequential or any damages, whatsoever.

**6. EFFECTIVE DATE AND DURATION OF THE TOT AGREEMENT**

This ToT agreement is made for startup of the products invented/patented by first party and shall be valid till pilot study and survey of market feasibility. However the further actions involved in commercialization shall be governed by separate agreement.

**7. AMENDMENT TO TOT AGREEMENT**

No amendment to this ToT agreement shall be valid unless the same is made in writing jointly by the parties hereto or their authorized representatives and specifically stating the same to be an amendment to this ToT agreement.



**8. TERMINATION OF TOT AGREEMENT**

- 8.1 The ToT agreement shall not be terminated by first and second party during ongoing financial year.
- 8.2 This ToT agreement can be terminated by any party giving the other party, a prior written notice of not less than 60 days of its intention to do so but without dishonoring any commitment entered into prior to the date of termination notice.
- 8.3 Despite termination, the parties shall abide by the usual professional ethics and normal code of conduct to maintain the confidentiality of the information and any IPRs.

**9. SETTLEMENT OF DISPUTES**

Any dispute arising in relation to or in connection with this ToT agreement between the parties shall be resolved by mutual negotiations. In case of any unresolved dispute, the parties shall refer the said dispute for arbitration, to the sole arbitrator appointed by all the Parties and the decision of the arbitrator shall be final and binding on all the three parties. The provisions of Arbitration and Conciliation Act, 1996 shall apply to such arbitration. Such arbitration proceeding shall be held at Satara Jurisdiction.



**Add. Director of Research**  
KIMSDU, Karad

IN WITNESS WHEREOF the parties hereby execute this Agreement on the day and year first above written.

For KIMSDU

  
-----  
Authorized Signatory  
Name: Dr. M. V. Ghorpade  
Designation: Registrar  
Date:

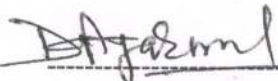

Witness for KIMSDU

  
-----  
Authorized Signatory  
Name: Dr. D.K. Agaswal  
Designation: Add. Dir. Research  
Date: 24/12/2019

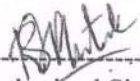

  
-----  
Authorized Signatory  
Name: Mr. Rohan S. Phatak  
Designation: Jr. Research Officer  
Date: 24/12/2019

For GI India Automation and Systems Private Limited

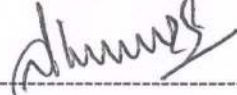
  
-----  
Authorized Signatory  
Name: Mr. Jay Kanhere  
Designation: Proprietor  
Date:

Witness for GI India Automation and Systems Private Limited

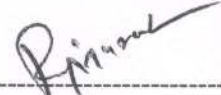
  
-----  
Authorized Signatory  
Name: Raju Marathe  
Designation:  
Date:

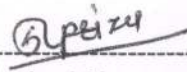
  
-----  
Authorized Signatory  
Name: Supriya Choudhary  
Designation:  
Date: 2

  
Add. Director of Research  
KIMSDU, Karad

**FORM-2**

THE PATENTS ACT, 1970

(39 OF 1970)

&

THE PATENT RULES, 2003

**COMPLETE SPECIFICATION**

(SECTION 10, RULE 13)

**TITLE**

“SIMULATION TRAINING DEVICE FOR ASSESSMENT OF THE CERVICAL DILATATION”

**APPLICANT(S)**

KRISHNA INSTITUTE OF MEDICAL SCIENCES, Deemed to be University declared U/s 3 of UGC Act 1956 vide notification no. F.9-15/2001-U-3 of the Ministry of Human Resource Development Govt. of India having an address of Krishna Institute of Medical Sciences, near Dhebewadi Road, Malkapur, Karad, Pin code- 415110, Maharashtra, India

The following specification particularly describes the nature of the invention and the manner in which it is to be performed



## **TECHNICAL FIELD:**

The present invention relates to the field of Medical Sciences as a training tool for assessment of cervical dilatation for (i) undergraduate and postgraduate students form obstetrics & gynecology (ii) Nursing students and professionals, (iii) traditional birth attendants.

## **BACKGROUND OF THE INVENTION:**

At present, the assessment of cervical dilatation is done by a teacher in obstetrics and gynaecology and then the student is asked to do internal examination of the woman and told size of cervix which the student has to remember and fix in his mind as a particular size of cervix either in fingers or in cms.

When series of students palpate internally there is risk of infection to the patient due to repeated internal examinations apart from psychological trauma and physical botheration of getting examined vaginally.

This training is transferring subjective impression of one person to another person without facilitating visual guidance about actual size of the cervix.

Each and every student of medicine and nursing has to undergo such training without facilities for forming their judgment on a dummy model. Such training is far from perfect and is likely to result in lacunae in training and the trained person is likely to have inaccurate judgment of size of the cervix.

## **SUMMARY OF THE INVENTION:**

A novel innovative device is made available for training in obstetrics and gynaecology for judgment of size of cervical dilatation from 3cms to 10cms on an inanimate object before embarking on vaginal examination for judging cervical dilatation in a live subject.

Hence this simulation training device for the assessment of the cervical dilatation was designed so that one can practice and perfect oneself in judging the size of hole accurately before actually performing internal vaginal examination for assessing size of cervix in a live subject.

Rubber Rings from 3cms to 10cms are fitted on corresponding sized holes on the rotating drum. The handle attached to it can be put at desired cervical size to get that size on the drum which can be palpated by fingers inserted from the round opening kept on the front side of the rectangular box of the device. Once one is accustomed to the size of the opening visually and by palpation, the opaque piece of cloth of the device can be made to block the vision of the person learning to judge the size of the opening by palpation thus simulating vaginal examination where one has to judge the size of cervix without advantage of visually seeing it.

The device has a block board platform (10) for supporting the parts of the machine. The device has a rotating plastic drum or cylinder (6) which has eight holes from 3 cm to 10 cm diameter on which rubber rings are fitted (8). The cylinder is closed on both sides by plastic discs which are glued to the cylinder, which in turn are connected to the shaft (12) through one wooded hub (15) on each side. The hub is screwed to the disc and to the shaft. Thus the cylinder is rigidly connected to the shaft.

The cylinder is covered by the box (1) to ensure that the holes on the cylinder can't be seen from outside and also to protect the inner parts. The front side of the box (1) has an opening (5) which is covered by the curtain (13).

The shaft is mounted in two wooden bearings (14) which are fixed on the block board platform (10) through support for the bearings (11) on both the sides. The indexing mechanism is on the right hand side. This mechanism consists of spring loaded lock (9) and slotted indexing wheel (2). The slotted indexing wheel is fixed to the shaft by means of a screw. The indexing allows the drum to rotate in one direction only. The direction is marked on the turn wheel (16). By rotating indexing wheel (2), rubber ring fitted holes (8) can be brought in the centre of the opening (5) on the box (1) one at a time. The axial central position of the holes is ensured by the suitable spacers (7). The indexing mechanism synchronizes the hole size with the number indicated by the indicator arrow on the circular scale (3). By rotating the turn wheel the holes on the cylinder come one by one in line with the opening (5) on the box (1).

The shaft extends out of the box (1) from the right hand side. The turn wheel (16) is mounted on the shaft on the outside of the box (1). This has a handle (4) for rotation. It also has a indicator arrow and a direction arrow showing direction of rotation. A

circular scale (3) is printed on the box just below the turn wheel. The turn wheel (16), the cylinder (6) and the indexing mechanism are so synchronized that the diameter of the hole on the cylinder (6) in front of the opening on the box is correctly shown by the indicator arrow on the turn wheel. The trainee student has to learn judging the diameter of the hole by sensing the hole diameter only with the touch and correlating with corresponding number indicated by the arrow.

The hole on the box is covered with the curtain. This facilitates selective viewing of the holes and palpating it at the same time. After this, blind palpitation can be undertaken for each of the holes by the trainee student. After gaining confidence of his judgment of the side of the hole by way of repeated blind palpitations on the machine, he is now ready for learning on the live subjects.

### **STATEMENT OF THE INVENTION**

Such as herein a simulating training device (17) for viewing and palpating assessment of the cervical dilatation consisting of a wooden box (1), the said box comprises of a circular opening (5) and an opaque curtain (13), a drum (6) having eight holes of diameter of 3-10 cm, rings (8), a shaft (12), spacers (7), a locking system (9) and an indexing wheel (2) and a turn wheel (16) wherein said wheel (2) allows the drum (6) to rotate in one direction,

a platform (10) means to support the box;

20

a handle (4) means to rotate;

a circular scale (3);

25

characterized in that the said ring (8) being fixed onto the said hole and the said wheel (16) being fixed outside the box; and

said shaft (12) being extended to the outside box (1) and said wheel (16) being connected to the extended shaft (12); and

30

said wheel (2) being fixed onto the shaft (12) and said scale (3) being fixed below the wheel (16);

5 such that the ring fitted hole (8) attains the central position of the opening (5) of the box (1) one at a time upon rotation of the indexing wheel (2) and the ring fitted hole (8) attains the central position of the opening (5) of the box (1) one by one in line upon rotation of the turn wheel (16).

#### **BRIEF DESCRIPTION OF THE ACCOMPANYING DRAWINGS:**

10 Fig. No. 1 is the schematic representation (cross-sectional top view) of the simulation training device for assessment of the cervical dilatation showing the two wooden hubs (15) and slotted indexing wheel (2) in accordance with the present invention;

15 Fig. No. 2 is the schematic representation (cross-sectional view) of the training device consists of the rotating plastic drum or cylinder (6), support houses the spring loaded lock (9) of the indexing mechanism, a block board platform (10), the shaft (12), two wooden bearings (14), two supports for the bearing (11) and suitable spacer (7) in accordance with the present invention;

Fig. No. 3 is the schematic representation (top view) of the training device consists of the handle (4) for rotation in accordance with the present invention;

20 Fig. No. 4 is the schematic representation (front view) of the training device consists of the box (1), an opening in the box (5), which is covered by the curtain (13), the turn wheel (16) and rubber rings fitted hole (8) in accordance with the present invention;

Fig. No. 5 is the schematic representation (side view) of the training device having a circular scale (3) in accordance with the present invention.

#### **DETAILED DESCRIPTION OF THE INVENTION**

25 Referring to Fig. No. 1-5, the training device for viewing and palpating assessment of cervical dilation consist of the two wooden hubs (15) and slotted indexing wheel (2). The two wooden hubs are connected to the shaft through one wooden hub (15) on each side. The slotted indexing wheel (2) is fixed to the shaft by means of the screw. The indexing allows the drum to rotate in one direction. The device also consist of the

rotating plastic drum or cylinder (6), spring loaded lock (9), a block board platform (10), the shaft (12), two wooden bearings (14) and suitable spacer (7).. The cylinder (6) is closed on both sides by plastic discs which are glued to the cylinder, which in turn are connected to the shaft (12) through one wooden hub (15) on each side. The hub (15) is screwed to the disc and to the shaft. Thus the cylinder (6) is rigidly connected to the shaft (12). The shaft (12) is mounted in two wooden bearings (14) which are fixed on the block board platform (10) through support for the bearing (11) on both the sides. The right hand side of the support for the bearing (11) houses the spring loaded lock (9). The device further consists of the handle (4) for rotation. It also has an indicator arrow (17) and a direction arrow showing direction of rotation. The device consists of the box (1), an opening (5), which is covered by the curtain (13), the turn wheel (16) the rubber ring fitted holes (8). The cylinder (6) is covered by the box (1) to ensure that the holes on the cylinder (6) can't be seen from outside and also to protect the inner parts. The box (1) has an opening (5) which is covered by the curtain (13). The direction is marked on the turn wheel (16). The indexing mechanism synchronizes the rubber ring fitted holes (8) on the periphery of the cylinder (6) can be brought in the centre of the opening (5) of the box (1) one at a time. By rotating the turn wheel (16) the holes (8) on the cylinder (6) come one by one in line with the opening (5) on the box (1). The device also consists of the circular scale (3) which is printed on the box just below the turn wheel (16) and the said scale is having an indicator arrow (17) for indicating the diameter of the hole (8) .

To teach the cervical dilatation according to present invention, following steps are to be undertaken:

1. With the rotating handle the size of opening is to be fixed.
- 25 2. The student is given a view of rubber ring fitted circular opening of desired diameter.
3. The student is made to palpate it many times till it is fixed in his memory.
4. The ability of the student is judged by blinding him/her by putting opaque curtain and making him identify the size of the opening from 3cms diameter to  
30 10cms diameter.

5. Once the student is trained to identify the size of the opening correctly, he/she is allowed to do vaginal examination and judge the size of cervical opening in live subjects.

5 These steps will facilitate the student to learn size of the cervix accurately by viewing and palpatory method.

Applications/ uses:

- (i) Simulates vaginal examination in view of both viewing & palpating;
- (ii) Saves repeated learning attempts at judging the size on live subjects;
- (iii) Readily available, can be manipulated to fix known desired size of opening on the  
10 model.; &
- iv) Repeated examinations on model are possible without any harm of infection or trauma to a live subject.

**We Claim,**

1. A simulating training device for viewing and palpating assessment of the cervical dilatation consisting of a wooden box (1) having rectangular shape, the said box comprises a circular opening (5) and an opaque curtain (13), a drum (6) having eight holes of diameter of 3-10 cm, rings (8), a shaft (12), spacers (7), a locking system (9) and an indexing wheel (2) and a turn wheel (16) wherein said wheel (2) allows the cylinder (6) to rotate in one direction ,

a platform (10) means to support the box;

a handle (4) means to rotate;

a circular scale (3);

characterized in that the said ring (8) being fixed onto the said hole and the said wheel (16) being fixed outside the box; and

said shaft (12) being extended to the outside box (1) and said wheel (16) being connected to the extended shaft (12); and

said wheel (2) being fixed onto the shaft (12) and said scale (3) being fixed below the wheel (16);

such that the ring fitted hole (8) attains the central position of the opening (5) of the box (1) one at a time upon rotation of the indexing wheel (2) and the ring fitted hole (8) attains the central position of the opening (5) of the box (1) one by one in line upon rotation of the turn wheel (16).

Dated this 09<sup>th</sup> day of March, 2010

*Arghya Roy*

(Arghya Ashis Roy)  
Patent Agent (IN/PA 2346)  
Of Lex-Regia  
For the Applicant(s)

To,  
The Controller of Patents,  
The Patent Office  
Mumbai

## **ABSTRACT**

### **“SIMULATION TRAINING DEVICE FOR ASSESSMENT OF THE CERVICAL DILATATION”**

Disclosed is a simulating training device for assessment of the cervical dilatation. The said device basically is a wooden box (1) with a circular opening (5) and an opaque curtain (13). Inside the wooden box there is rotating drum/cylinder (6) with a handle (4). Circular opening with diameter a desired size can be brought in the centre of the orifice with the handle. By putting index and middle fingers in the orifice the opening can be palpated under vision or as a blind procedure. After mastering the judgment of the size of the opening from 3cms to 10cms diameter, on the model, actual training of vaginal examination in a living being can be undertaken for further skill development of judgment of cervical dilatation minimizing risk of infection and botheration to the delivering women. Figure 2 & 4



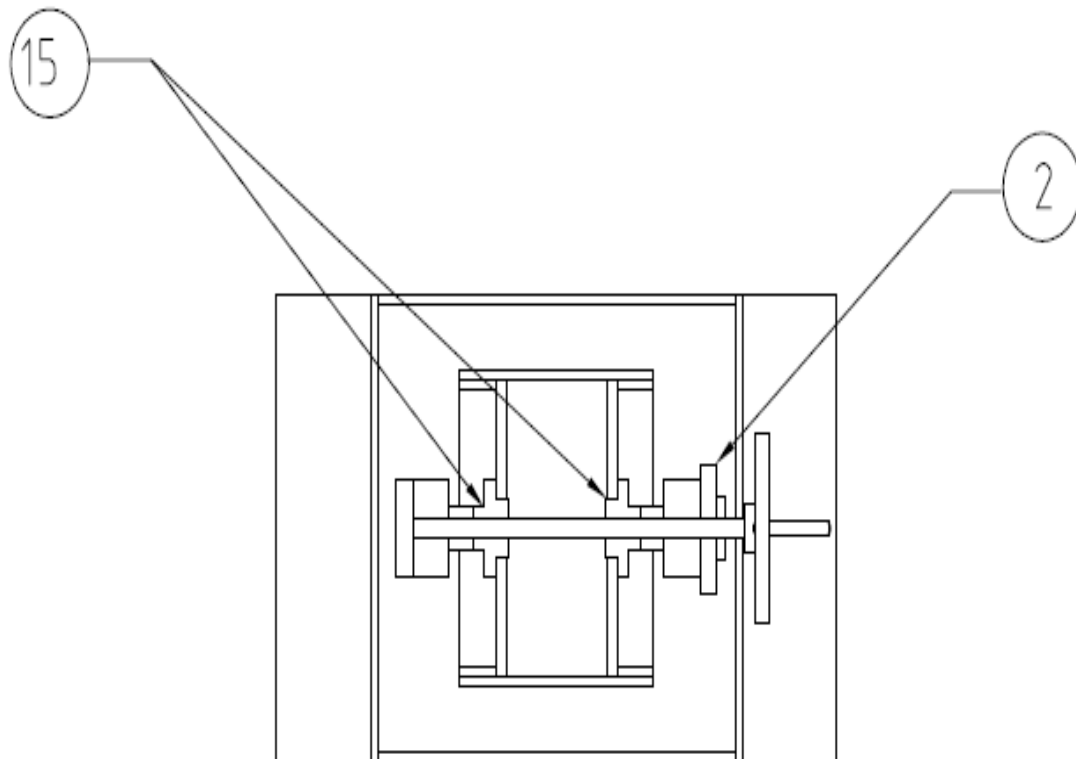

Figure 1

*Arghya Roy*

(Arghya Ashis Roy)  
Patent Agent (IN/PA 2346)  
Of Lex-Regia  
For the Applicant(s)

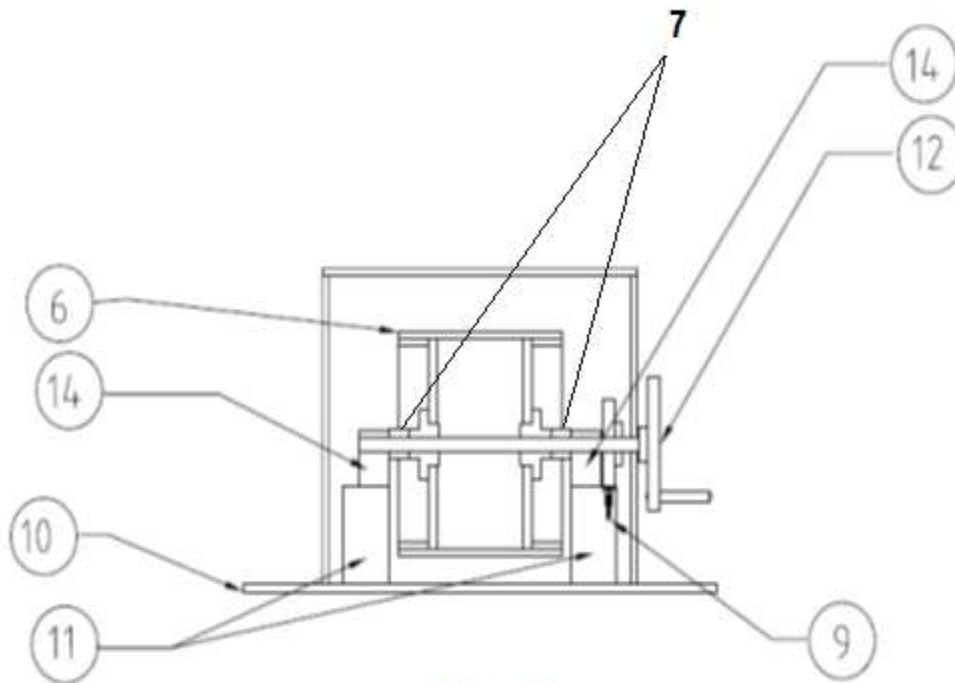

Figure 2

*Arghya Roy*

(Arghya Ashis Roy)

Patent Agent (IN/PA 2346)  
Of Lex-Regia  
For the Applicant(s)

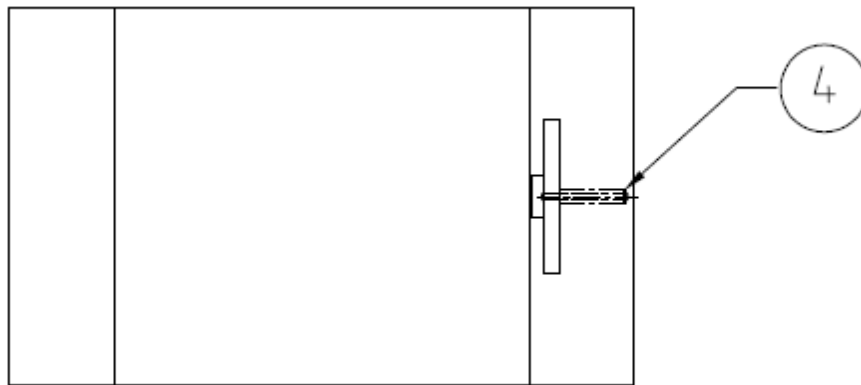

Figure 3

*Arghya Roy*

(Arghya Ashis Roy)  
Patent Agent (IN/PA 2346)  
Of Lex-Regia  
For the Applicant(s)

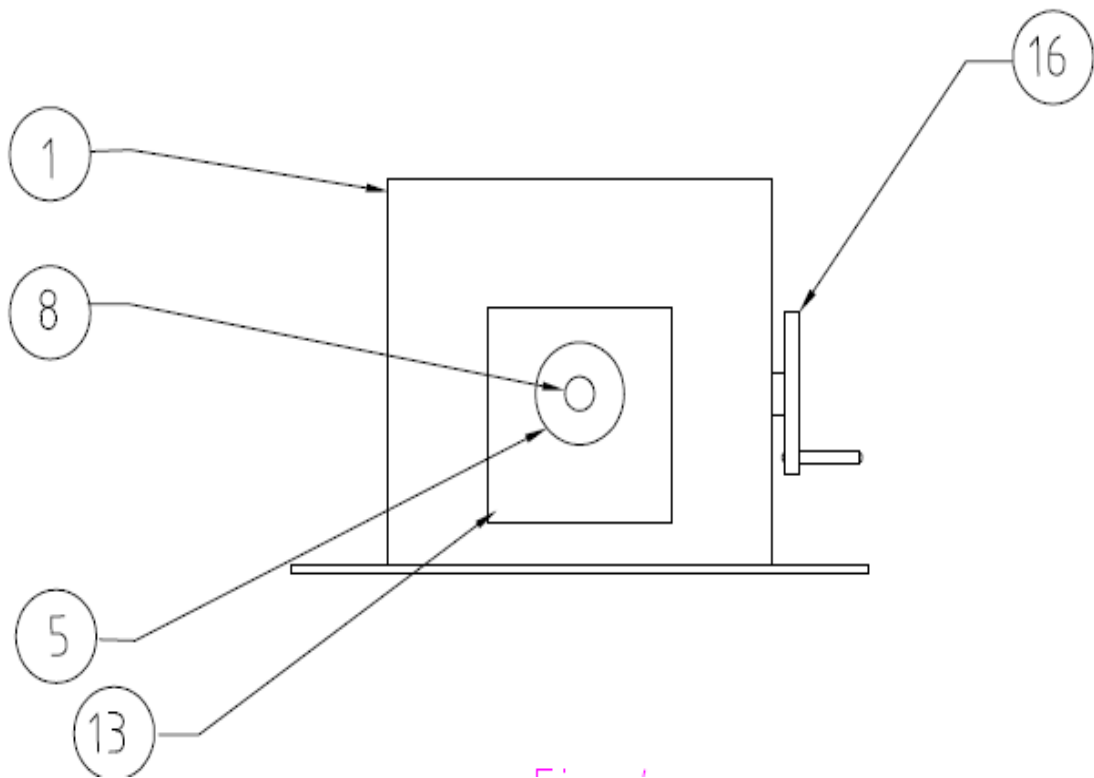

Figure-4

*Arghya Roy*

(Arghya Ashis Roy)  
Patent Agent (IN/PA 2346)  
Of Lex-Regia  
For the Applicant(s)

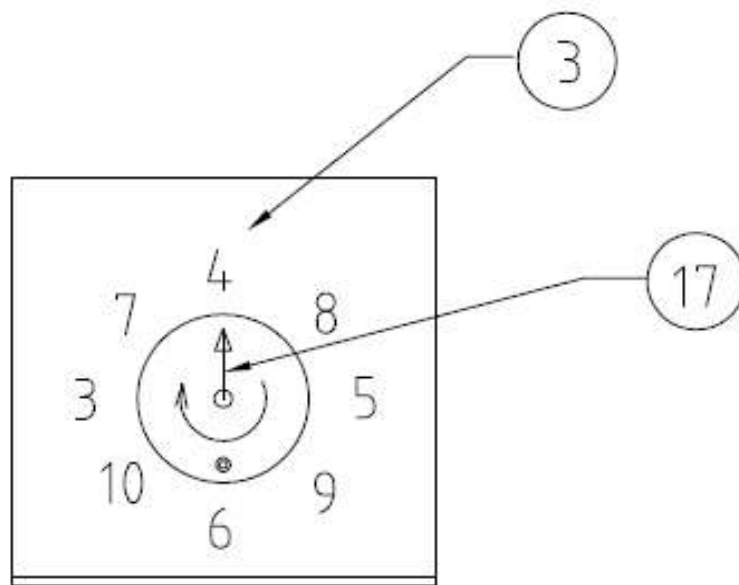

Figure-5

*Arghya Roy*

(Arghya Ashis Roy)  
Patent Agent (IN/PA 2346)  
Of Lex-Regia  
For the Applicant(s)

## Transfer of Technology Agreement

This Transfer of Technology Agreement (hereinafter referred to as "ToT") is made at Krishna Institute of Medical Sciences "Deemed to be University" (KIMSDU), Karad for the transfer of technology entitled "An orthotic device for supporting a shoulder joint of a user" and "Customised ankle foot orthotic device" developed by KIMSDU, Karad. This Technology Transfer ("ToT") Agreement made and entered into on this 18<sup>th</sup> day of December, 2019.

### BETWEEN

**Krishna Institute of Medical Sciences** "Deemed to be University", Karad ('KIMSDU'), through the Registrar, hereinafter referred to as "First Party"

### AND

**Opex Accelerator Private Limited**, Kolhapur through COE and founder Mr. Sachin Kumbhoje, hereinafter referred to as "Second Party".

WHEREAS the KIMSDU is an recognized Medical "Deemed to be university", accredited by NAAC with A grade, an ISO 9001:2015 certified University and is accredited by various reputed National and International bodies, having education and research expertise in the field of medical, paramedical, nursing, pharmaceutical and allied sciences.

WHEREAS the Opex Accelerator Private Limited is involved in the manufacturing and marketing of biomedical products and an authorized startup company

AND WHEREAS both the parties KIMSDU and Opex Accelerator Private Limited desire to spell out the terms and conditions in respect of this collaboration and to enter into a Technology Transfer (ToT) Agreement for that purpose.

### NOW IT IS AGREED BY AND BETWEEN THE PARTIES AS UNDER

#### 1. SCOPE/TERMS OF COLLABORATION

- 1.1. The ToT agreement entitled to provide all the technical details about product on as is where is basis in order to achieve smooth manufacturing practices (details given in patent literature).
- 1.2. The charges for authentication and certifications of the product from competent authority shall be paid by "First party".
- 1.3. The second party shall not alter or dilute the quality of product as per the specifications made under the document of ToT which has been authenticated and approved by competent authorities (Controller of Patent).
- 1.4. The first party shall not enter into the manufacturing or marketing of the product directly or indirectly.
- 1.5. The first party shall grant the design details of ToT agreement to the second party after the signing of this ToT agreement.



**Add. Director of Research**  
KIMSDU, Karad

- 1.6. Any kind of breach in the conditions which has been mentioned in this document shall amount to withdrawal of this agreement by First party.

## 2. INTELLECTUAL PROPERTY RIGHTS AND PUBLICATIONS (IF ANY)

- 2.1 Notwithstanding anything contained to the contrary, the entire rights, title and interest in any intellectual property including but not limited to patent and publications emerging out of the collaborative research to be carried out under this ToT ("IP") agreement, will be jointly owned by both the parties, if it is during the research and Development work.
- 2.2 The exclusive right of business and product development out of the patent, development will remain with both the parties and in case of second party after authenticity transferring for commercialization and licensing which shall be covered by separate agreement for royalty distribution.

## 3. CONFIDENTIALITY

- 3.1 The term "Confidential Information" shall mean any information disclosed by one party ("Discloser") to the other ("Receiver"), pursuant to this ToT agreement or otherwise, which is in written, graphic, machine readable or other tangible form and is marked as 'Confidential' or 'Proprietary' or in some other manner to indicate its confidential nature. Confidential information may also include oral information disclosed by one party to the other, pursuant to this ToT agreement, provided that such information is designated as Confidential at the time of disclosure and reduce to a written summary by the disclosing party, within 30 days after its oral disclosure, which is marked in a manner to indicate its confidential nature and delivered to the receiving party.
- 3.2 For the term of this ToT agreement, each party, shall treat as confidential all confidential information of the other party, shall not use such confidential information except as expressly set forth herein or otherwise authorized in writing, shall implement reasonable procedures to prohibit the disclosure, unauthorized duplication, misuse or removal of the other parties confidential information and shall not disclose such confidential information to any third party except as may be necessary and required in connection with the rights and obligations of such party under this ToT agreement. Without limiting the foregoing, each of the parties shall use at least the same procedures and degree of care which it uses to prevent the disclosure of its own confidential information of like importance to prevent the disclosure of confidential information disclosed to it by the other party under this ToT agreement.
- 4.3 Confidential information shall not include the information which,
  - i) was generally known and available at the time it was disclosed or becomes generally known and available through no fault of the



receiver, was known to the recipient of such information, without restriction, at the time of disclosure as shown by the files of the recipient in existence at the time of disclosure,

- ii) is disclosed with the prior written approval of the disclosure,
- iii) was independently developed by the receiver without any use of the confidential information, and by employees and other agents of the receiver who have not been exposed to the confidential information, provided that the receiver can demonstrate such independent development by documented evidence prepared contemporaneously with such independent development.
- iv) becomes known to the receiver, without restriction, from a source other than the discloser without breach of this ToT agreement by the receiver and otherwise, not in violation of the discloser's rights.
- v) In addition, each party shall be entitled to disclose the other parties confidential information to the extent such disclosure is requested by the order or requirement of a Court, administrative agency, or other governmental body, provided that the party required to make the disclosure shall provide prompt and advance notice thereof, to enable the other party to seek a protective order or otherwise prevent such disclosure.

#### **5. RELATIONSHIP OF THE PARTIES**

Nothing in this ToT agreement is intended to create a partnership, joint venture or other form of relationship between the Parties. Neither party makes any representations or warranties, whether express or implied. Neither party shall be liable to other for any indirect, consequential or any damages, whatsoever.

#### **6. EFFECTIVE DATE AND DURATION OF THE TOT AGREEMENT**

This ToT agreement is made for startup of the products invented/patented by first party and shall be valid till pilot study and survey of market feasibility. However the further actions involved in commercialization shall be governed by separate agreement.

#### **7. AMENDMENT TO TOT AGREEMENT**

No amendment to this ToT agreement shall be valid unless the same is made in writing jointly by the parties hereto or their authorized representatives and specifically stating the same to be an amendment to this ToT agreement.

#### **8. TERMINATION OF TOT AGREEMENT**

- 8.1 The ToT agreement shall not be terminated by first and second party during ongoing financial year.



Add. Director of Research  
KIMSDU, Karad



8.2 This ToT agreement can be terminated by any party giving the other party, a prior written notice of not less than 60 days of its intention to do so but without dishonoring any commitment entered into prior to the date of termination notice.

8.3 Despite termination, the parties shall abide by the usual professional ethics and normal code of conduct to maintain the confidentiality of the information and any IPRs.

## 9. SETTLEMENT OF DISPUTES

Any dispute arising in relation to or in connection with this ToT agreement between the parties shall be resolved by mutual negotiations. In case of any unresolved dispute, the parties shall refer the said dispute for arbitration, to the sole arbitrator appointed by all the Parties and the decision of the arbitrator shall be final and binding on all the three parties. The provisions of Arbitration and Conciliation Act, 1996 shall apply to such arbitration. Such arbitration proceeding shall be held at Satara Jurisdiction.

IN WITNESS WHEREOF the parties hereby execute this Agreement on the day and year first above written.

For KIMSDU



Authorized Signatory  
Name: Dr. M. V. Ghorpade  
Designation: Registrar  
Date:



For OpEx Accelerator

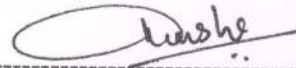

Authorized Signatory  
Name: Mr. Sachin Kumbhoje  
Designation: **Director**  
Date: **OpEx Accelerator Pvt. Ltd.**  
**Kolhapur.**

Witness for KIMSDU

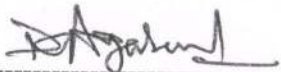

Authorized Signatory  
Name: **Dr. D. K. Agarwal**  
Designation: **Add. Dir. Research**  
Date: **18/12/2019**

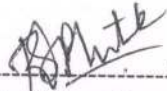

Authorized Signatory  
Name: **Mr. Rohan S. Phatak**  
Designation: **Jr. Research officer**  
Date: **18/12/2019**

Witness for OpEx Accelerator



Authorized Signatory  
Name: **Ms. Anjori Perrandokan**  
Designation: **Director**  
Date: **OpEx Accelerator Pvt. Ltd.**  
**Kolhapur.**

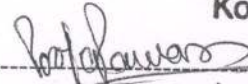

Authorized Signatory  
Name: **Ms. Pooja Pawar**  
Designation: **Asst. Manager**  
Date:



**Add. Director of Research**  
**KIMSDU, Karad**

**FORM 2**  
**THE PATENT ACT 1970**  
**AND**  
**THE PATENTS RULES, 2003**  
**COMPLETE SPECIFICATION**  
**(SEE SECTION 10 AND RULE 13)**

<p><b>1. TITLE OF THE INVENTION:</b> “An Orthotic Device for Supporting a Shoulder Joint of a User.”</p>	
<p><b>2. APPLICANT(s):</b></p> <p>(a) <b>NAME:</b> Krishna Institute of Medical Science “Deemed to be University”.</p> <p>(b) <b>NATIONALITY:</b> Indian Deemed Institute</p> <p>(c) <b>ADDRESS:</b> NH 4, Near Dhebewadi Road, Malkapur, Karad - 415539, Maharashtra.</p>	
<p><b>3. PREAMBLE TO THE DESCRIPTION:</b></p>	
<p style="text-align: center;"><del><b>PROVISIONAL</b></del></p> <p><del>The following specification describes the invention.</del></p>	<p style="text-align: center;"><b>COMPLETE</b></p> <p>The following specification particularly describes the invention and the manner in which it is to be performed</p>

## **Field of the Invention**

[0001] The present invention relates to an orthotic device. More specifically, the present invention relates to an orthotic device for supporting a  
5 shoulder joint of a user. The orthotic device can be an orthosis.

## **Background of the Invention**

[0002] Generally, orthosis is used to support body parts of patients  
10 under the circumstances such as injuries, dislocations, subluxation and the like. The orthosis is general term used for any orthotic device. These orthosis are also used to treat shoulder joint misalignments caused due to strokes (paralysis), shoulder subluxation and the like. A stroke is an acute onset of neurological dysfunction caused due to the abnormality in a cerebral blood circulation with  
15 resultant sign and symptom that correspond to the involvement of focal areas of the brain. It can give the symptoms like paralysis (hemiplegia) or weakness (hemiparesis). Shoulder subluxation is a common problem in the stroke. The subluxation causes shoulder pain and hinders activity.

20 [0003] Figures 1a & 1b illustrates schematic views of a shoulder joint 200 anatomy of a human (user) 500 in a normal condition and a shoulder subluxation condition respectively. A shoulder joint 200 is a ball and socket type

of synovial joint with 3 degrees of freedom. It is the most mobile joint of the human body..

[0004] A normal stirring action of the force couple of supraspinatus and posterior fibers of the deltoid is affected due to a flaccid stage of the muscles. So, while abduction and flexion movement due to gravitational pull to the head of the humerus subluxates caudally. Presently, Orthotic devices (shoulder orthosis) are used to support the shoulder joint 200 to decrease the glenohumeral subluxation.

10

[0005] Further, when a patient (user) 500 suffering from the Shoulder subluxation condition is wearing the existing orthosis at the shoulder joint 200, an upper arm 220 of the patient can be moved away from a torso 240 up to a maximum of 30 degrees from a vertical reference 230. Whenever the patient moves the upper arm 220 away from the torso 240 (In medical terms, this movement is called an “abduction movement”) there will be a set of forces acting on the shoulder joint 200 and the upper arm 220. Angle of abduction movement can be referred as a movement angle  $\theta_m$ . These set of forces are caused due to movements along a direction 250 away from the torso 240. These forces cause an enormous amount of pain to the patient even when the patient is wearing the orthosis. Furthermore, these movements also effect the subluxation condition of the patient 500, thereby reduces efficiency of the orthosis in treating the subluxation condition.

[0006] Presently existing orthosis or any such devices are not effective in reducing effects caused due to forces developed during movements of an arm 200a of the user 500 (abduction movement) and also in efficiently treating the subluxation condition during abduction movements.

5

[0007] Further, the existing orthosis are costly, therefore not affordable.

[0008] Therefore, there is a need for an orthotic device (orthosis),  
10 which overcomes few or more problems of the prior art.

### **Objects of the Invention**

[0009] An object of the present invention is to provide an orthotic  
15 device for supporting a shoulder joint of a user.

[0010] Another object of the present invention is to provide an orthotic device for supporting a shoulder joint of a user, which nullifies forces caused on the user due to movements of an arm of the user while wearing the  
20 orthotic device.

[0011] Still another object of the present invention is to provide an orthotic device for supporting a shoulder joint of a user, which is simple in construction.

5 [0012] Further an object of the present invention is to provide an orthotic device for supporting a shoulder joint of a user, which is easy to use.

[0013] Further an object of the present invention is to provide an orthotic device for supporting a shoulder joint of a user, which is economical in  
10 construction.

[0014] Furthermore, an object of the present invention is to provide an orthotic device for supporting a shoulder joint of a user for reducing the pain of the user caused due to movements of an arm of the user while wearing the orthotic  
15 device.

[0015] Also, an object of the present invention is to provide an orthotic device for supporting a shoulder joint of a user for treating the subluxation condition of the patients effectively even if any movements of an  
20 arm(hand) of a user is occurred while wearing the orthotic device.

## Summary of the invention

[0016] According to the present invention there is provided with an orthotic device for supporting a first shoulder joint of a user. The first shoulder  
5 can be a right shoulder joint of the user and a second shoulder joint is a left shoulder joint of the user and vice-versa. The orthotic device may include a rigid support, at least one pair of electrodes, at least one first strap and at least one-second strap. The rigid support is having an outer surface and an inner surface. The rigid support is resting against the first shoulder.

10

[0017] In a preferred embodiment, the rigid support is configured according to a shape of a shoulder the user and the rigid support is arranged on the first shoulder joint of the user with a surface contact of the inner surface of the orthotic device with the skin of the user. The rigid support includes a cushioning  
15 layer arranged on the inner surface of the rigid surface for providing the comfort of the user while wearing the orthotic device.

[0018] The at least one pair of electrodes arranged on the inner surface of the rigid support for pain relief modality. The at least one pair of  
20 electrodes are connected to a power source and a control unit for supplying and controlling current flow thereto. The at least one first strap is wrapped around an upper arm of the first shoulder for securing the orthotic device on the first shoulder of the user. The at least one first strap is arranged with a pad. The pad is

configured to provide support and pressure to the upper arm when the at least one first strap is wrapped around the upper arm of the user.

[0019] The at least one-second strap is extending from the rigid support and adapted to wrap around an armpit of the second shoulder joint. The at least one-second strap is extending from the outer surface of the rigid support. In an embodiment, the at least one-second strap is extending from the outer surface of the rigid support. More specifically, the at least one-second strap is extending from a corner of a shoulder profile of the rigid support. The at least one-second strap distributes the force exerted on the first shoulder and the upper arm along the second strap towards the armpit of the second shoulder joint thereby nullifying the forces occurred during movements of a first arm (hand) of the user. Also, the at least one-second strap enables the orthosis to treat the subluxation condition of the user efficiently even if the user moves his/her arm while wearing the orthosis.

15

### **Brief Description of the Drawings**

[0020] The advantages and features of the present invention will be understood better with reference to the following detailed description of some embodiments of the impact energy absorber and claims taken in conjunction with the accompanying drawings, wherein like elements are identified with like symbols, and in which;



[0021] Figure 1a shows a schematic view of a shoulder joint of a human with a normal condition;

[0022] Figure 1b shows a schematic view of a shoulder joint of a human with a shoulder subluxation condition;

[0023] Figures 2 shows an isometric view of an orthotic device for supporting a first shoulder joint of a user in accordance with the present invention;

[0024] Figure 3 shows a front view of a preferred embodiment of an orthotic device for supporting a first shoulder joint of a user in accordance with the present invention;

[0025] Figure 4 shows a side view of figure 3;

[0026] Figure 5 shows a top view of figure 3; and

[0027] Figure 6 shows a schematic view of a user (patient) wearing the orthosis shown in figure 3.

20

## Detailed Description of the Invention

[0028] An embodiment of this invention, illustrating its features, will now be described in detail. The words "comprising, "having, "containing," and "including," and other forms thereof, are intended to be equivalent in meaning and be open ended in that an item or items following any one of these words is not meant to be an exhaustive listing of such item or items, or meant to be limited to only the listed item or items.

10 [0029] The terms "first," "second," and the like, herein do not denote any order, quantity, or importance, but rather are used to distinguish one element from another, and the terms "an" and "a" herein do not denote a limitation of quantity, but rather denote the presence of at least one of the referenced item.

15 [0030] The disclosed embodiments are merely exemplary of the invention, which may be embodied in various forms.

[0031] Referring to figures 2, 3 4, and 6, various c views of an orthotic device 100 for supporting a first shoulder joint 200 (figure 1a & 1b) of a user 500 in accordance with the present invention are illustrated. The user 500 here refers to a patient suffering from a shoulder subluxation condition or similar health alignments and aided with the orthosis 100 for treating the same. For the purpose of explanation, the first shoulder joint 200 is a left shoulder joint of the

user 500 and a second shoulder joint 400 is a right shoulder joint of the user 500. Alternatively, the first shoulder joint 200 can be a right shoulder joint of the user 500 and the second shoulder joint 400 is a left shoulder joint of the user 500, which is obvious to a person skilled in the art. The orthotic device 100 is an  
5 orthosis.

[0032] The orthotic device 100 includes a rigid support 10, at least one pair of electrodes 20a & 20b, at least one first strap 30 and at least one-second strap 40. The rigid support 10 includes a shoulder section 12 and an arm section  
10 14. More specifically, the shoulder section 12 covers a shoulder section of the user 500 and the arm section 14 covers an upper arm 220 section of the user 500. The rigid support 10 is having an outer surface 10a and an inner surface 10b. The rigid support 10 is resting against the first shoulder joint 200.

15 [0033] In a preferred embodiment, the rigid support 10 is configured according to a shape of a shoulder of the user 500. The rigid support is arranged on the first shoulder joint 200 of the user 500 with a surface contact of the inner surface 10b of the orthotic device 100 with the skin of the user 500. The rigid support 10 includes a cushioning layer 16 arranged on the inner surface 10b of the  
20 rigid support for providing comfort to the user while wearing the orthotic device 100. The cushioning layer 16 can be made from materials, such as medicinal rubber or ethaflex and the like. The rigid support 10 is made from materials, such as polypropylene and the like.

[0034] The at least one pair of electrodes 20a and 20b are arranged on the inner surface 10b of the rigid support 10 for pain relief modality. The pair of electrodes 20a & 20b are connected to a power source (not show) and a control unit (not show) for supplying and controlling current flow thereto. The power source can be an external power source or at least a battery. In the present embodiment, the orthotic device 100 includes two pairs of electrodes 20a, 20b & 24a, 24b. The pair of electrodes 20a & 20bis connected to the power source and the control unit through wires 22a & 22b. The wires 22a & 22b passes through openings (not shown) configured in the rigid support 10. It may be obvious to a person skilled in the art to configure the openings for passing the wires 22a & 22b therethrough and connecting the wires 22a & 22b to the pair of electrodes 20a & 20b; and arranging the pair of electrodes 20a & 20b on the inner surface 10b. Amount of current needs to be passed to the pair of electrodes 20a and 20b for pain relief modality is according to a specific medical condition. This amount of current passed according to the specific medical condition is known to a person ordinarily skilled in the art. The person ordinarily skilled in the art can be a physiotherapist or an electrotherapist.

[0035] Further, the at least one first strap 30 is arranged on the rigid support 10 to wrap around an upper arm 220 of the first shoulder joint 200 for securing the orthotic device 100 on the first shoulder joint 200 of the user.

[0036] In the present embodiment, the orthotic device 100 includes two first straps 30a & 30b. The first straps 30a and 30b are having a securing arrangements, such as a snap lock, hook and loop arrangement or any such obvious securing engagements which are capable to secure the orthotic device 100 on the upper arm 220 of the user 500. The first straps 30a and 30b are having a pad 50. The pad 50 is arranged with the first straps 30a and 30b. The pad 50 is configured to provide support and pressure to the upper arm 220 when the first straps 30a and 30b are wrapped around the upper arm 220 of the user 500. More specifically, the pad 50 is arranged in a such a way that, when the first straps 30a & 30b are wrapped around the upper arm 220, an interior surface of the pad 50 is in contact with the skin of the upper arm 220 as shown in figure 6. In an alternative embodiment (refer figure 2), the orthotic device 100 can be configured without the pad 50.

[0037] Referring again to figure 6, a schematic view of a user 500 wearing the orthotic device 100 is shown. The at least one-second strap 40 is extending from the rigid support 10 and adapted to wrap around an armpit 410 of the second shoulder joint 400. In the present, the orthotic device 100 includes a second strap 40. . In an embodiment, the second strap 40 is extending from the outer surface 10a of the rigid support 10. More specifically, the one-second strap 40 is extending from a corner 10c of a shoulder profile of the rigid support 10. The corner here refers to a geometric area where the shoulder section 12 and the hand section 14 of the rigid support 10 meets. In the present embodiment, the

second strap 40 is pinned at the shoulder section 12 of the rigid support 10 as shown in figure 5. The at least one-second strap 40 includes securing arrangements such as a hook and loop arrangements, =for securing the -second strap 40 around a torso 240 of the user 500 at the armpit 410 of the second  
5 shoulder joint 400.

[0038] Further, when the strap 40 at a wrapped position, does not allow the user 500 to move his/ her arm 220 beyond 30 degrees (a movement angle  $\theta_m$ ) from a vertical reference 230. This restriction of movement helps in  
10 retaining a correcting position of the rigid support 10 on the first shoulder joint 200. Hence, the orthotic device 100 corrects an affected shoulder efficiently. Hence, the second strap 40 also enables the orthotic device 100 in treating a subluxation condition of the user 500 efficiently even if the user 500 moves his/her arm 220 while wearing the orthosis 100.

15

[0039] When the orthosis 100 is worn by the user 500 around the first shoulder joint 200, by securing the first strap 30a around the upper arm 220 and securing the second strap 40 around the torso 240 around the armpit 410 of  
20 the second shoulder joint 400, the orthotic device 100 applies pressure on the first shoulder joint 200 according to a 3 point pressure system principle. In medical industry, this 3 point pressure system is known as a Jordon's principle. In the 3 point pressure system, the applied force and two counteracting forces are in the

opposite direction to each other. Further, supplying therapeutic current through the pair of electrodes 20a & 20b results in pain relief of the user 500. This supplying therapeutic current is generally known as TENS (transcutaneous electrical nerve stimulation). More specifically, this TENS gives pain relief to the user in the shoulder subluxation condition. Therefore, the orthotic device 100 is beneficial in reducing the shoulder subluxation condition along with the pain relief effect.

[0040] Furthermore, when the user 500 is wearing the orthotic device 100, if the user moves the arm 250 away from the torso 240, the second strap 40 distributes the force exerted on a first shoulder 202 and the upper arm 220 of the user 500 along the second strap 40 towards the armpit 410 of the second shoulder joint 400, thereby nullifying the forces occurred during movements of an arm 200a (first arm) of the user 500. When the forces occurred during movements of a first arm 200a of the user 500 are nullified, the resultant forces acting on the user 500 will be equal to zero. Therefore, the forces caused due to movement of the first arm 200a of the user 500 do not result in causing pain to the user 500 or any such discomforts.

[0041] Therefore, the present invention has the advantage of providing the orthotic device 100 for supporting the shoulder joint (200 or 400) of a user 500. The orthotic device 100 nullifies forces caused on the user due to movements of an arm 200a of the user 500. The orthotic device 100 is simple in construction. The orthotic device 100 is easy in use. The orthotic device 100 is

economical in construction and operations. The orthotic device 100 reduces the pain of the user 500 caused due to movements of an arm of the user 500 while wearing the orthotic device 100. The orthotic device 100 efficiently treats the subluxation condition of the patients even if any movements of an arm 200a of a user 500 is occurred while wearing the orthotic device 100.

[0042] The foregoing descriptions of specific embodiments of the present invention have been presented for purposes of illustration and description. They are not intended to be exhaustive or to limit the present invention to the precise forms disclosed, and obviously many modifications and variations are possible in light of the above teaching. The embodiments were chosen and described in order to best explain the principles of the present invention and its practical application, and to there by enable others skilled in the art to best utilise the present invention and various embodiments with various modifications as are suited to the particular use contemplated. It is understood that various omissions and substitutions of equivalents are contemplated as circumstances may suggest or render expedient, but such omissions and substitutions are intended to cover the application or implementation without departing from the scope of the claims of the present invention.

20



**We Claim:**

1. An orthotic device 100 for supporting a first shoulder joint 200 of a user, wherein the orthotic device 100 comprising:

5 a rigid support 10 having an outer surface 10a and an inner surface 10b, the rigid support 10 is resting against the first shoulder joint 200;

at least one pair of electrodes 20a & 20b arranged on the inner surface 10b of the rigid support 10 for pain relief modality;

10 at least one first strap 30 arranged on the rigid support 10, the at least one first strap 30a is wrapped around an upper arm 220 of the first shoulder joint 200 for securing the orthotic device 100 on the first shoulder joint 200 of the user; and

15 at least one-second strap 40 extending from the rigid support 10 and adapted to wrap around an armpit 410 of a second shoulder joint 400; wherein the at least one second strap 40 distributes the force exerted on the first shoulder joint 200 and the upper arm 220 along the second strap 40 towards the armpit 410 of the second shoulder 400 joint thereby nullifying the forces occurred during movements of the first arm 200a of the user and also efficiently treating a subluxation condition of the user even if the user moves his/her arm 220 while wearing the orthosis 100.

20 2. The orthotic device 100 as claimed in claim 1, wherein the first shoulder joint 200 can be a left shoulder joint of the user and the second shoulder joint 400 is a right shoulder joint of the user and vice-versa.

3. The orthotic device 100 as claimed in claim 1, wherein the rigid support 10 is configured according to a shape of a shoulder of the user and the rigid support 10 is arranged on the first shoulder joint 200 of the user with a surface contact of the inner surface 10b of the orthotic device 100 with the skin of the user.

5

4. The orthotic device 100 as claimed in claim 1, wherein the rigid support 10 includes a cushioning layer 16 arranged on the inner surface 10b of the rigid support 10 for providing comfort of the user while wearing the orthotic device 100.

10

5. The orthotic device 100 as claimed in claim 1, wherein the at least one pair of electrodes 20a & 20b are connected to a power source and a control unit for supplying and controlling current flow thereto.

15

6. The orthotic device 100 as claimed in claim 1, wherein the at least one first strap 30 is arranged with a pad 50, the pad 50 is configured to provide support and pressure to the upper arm 220 when the at least one first strap 30a is wrapped around the upper arm 220 of the user.

20

7. The orthotic device 100 as claimed in claim 1, wherein the at least one-second strap 40 is extending from the outer surface 10a of the rigid support 10.

8. The orthotic device 100 as claimed in claims 1 and 7, wherein the at least one-second strap 40 is extending from a corner 10c of a shoulder profile of the rigid support 10.

5 **Dated this May 13, 2019**



**Suneeet Baliram Sabale**  
**(Agent for Applicant)**

### **Abstract**

The present invention provides an orthotic device 100 for supporting a first shoulder joint 200 of a user 500. The orthotic device 100 includes a rigid support 10, at least one pair of electrodes 30a & 30b, at least one first strap 30 and the at least one-second strap 40. The rigid support 10 is having an outer surface 10a and an inner surface 10b and is resting against the first shoulder joint 200. The at least one first strap 30 is arranged on the rigid support 10 to wrap around an upper arm 220 of the first shoulder joint 200 for securing the orthotic device 100 on the first shoulder joint 200 of the user 500. The at least one-second strap 40 is extending from the rigid support 10 and adapted to wrap around an armpit 410 of a second shoulder joint 400 for efficiently treating a subluxation condition.

### **Figure 6**

15

**FORM-2**

THE PATENTS ACT, 1970

(39 OF 1970)

&

THE PATENT RULES, 2003

**COMPLETE SPECIFICATION**

(SECTION 10, RULE 13)

**TITLE**

“CUSTOMISED ANKLE FOOT ORTHOTIC DEVICE”

**APPLICANT(S)**

**SAMEER SUDHIR KARPE**, an Indian National, Krishna Institute of Physiotherapy,  
near Dhebewadi Road, Malkapur, Karad, Pin code- 415110, Maharashtra, India

The following specification particularly describes the nature of the invention and the  
manner in which it is to be performed

5 **FIELD OF THE INVENTION**

The present invention relates to an orthotics and physiotherapy field. More particularly, the present invention relates to an orthotic device which can be useful in foot drop problem of a patient suffering from strokes, multiple sclerosis, cerebral palsy patients, and in common peroneal nerve injury.

10

**BACKGROUND OF THE INVENTION**

Foot drop is common problem in stroke, multiple sclerosis, cerebral palsy patients, and in common peroneal nerve injury patient. Electrical stimulation and ankle foot orthosis (AFO) have been routinely used in individuals with foot drop to re-educate muscles which are weak and to keep ankle in neutral position. It is known that electrical stimulation is useful in treating individuals with foot drop. Studies (**Freeha Sharif, Samina Ghulam, Arshad Nawaz Malik and Quratulain Saeed, Effectiveness of Functional Electrical Stimulation (FES) versus Conventional Electrical Stimulation in Gait Rehabilitation of Patients with Stroke, Journal of the College of Physicians and Surgeons Pakistan 2017, Vol. 27 (11): 703-706**) showed that the functional electrical stimulation (FES) is better in foot drop than conventional electrical stimulation (EMS) in stroke patients.

15

20

Existing ankle foot orthosis and its drawback:

An ankle-foot orthosis, or AFO, is an orthotic device which is a support intended to control the position and motion of the ankle, compensate for weakness, or correct deformities of foot and ankle. AFOs can be used to support weak limbs, or to position a limb with contracted muscles into a more normal position. In addition, AFOs are used to control foot drop caused by a variety of neurologic and musculoskeletal disorders. Due to the common use for addressing foot drop, AFO has become synonymous with the term “foot-drop brace AFO are easy to wear, and can be easily available at orthotics.

30

5 Drawbacks:

- i) AFO limits mobility and range of motion of joint as it is not movable.
- ii) Movements is usually limited to certain direction..
- iii) There is restriction of rotation around a joint.
- iv) The aforesaid technologies failed to suggest the combined effect of AFO and  
10 cold & hot pack pouch in foot drop.

**Prior art:**

A document (<https://www.braceworks.ca/2018/09/20/devices/lower-limbs/afo/ankle-foot-orthoses-and-functional-electrical-stimulation-for-foot-drop-in-ms/>) discloses that the people with multiple sclerosis (MS) have difficulty  
15 walking: Gait impairment, including the reduced ankle dorsiflexion of foot drop, is one of the most common indicators of disability early in the course of this progressive autoimmune disease of the central nervous system, affecting approximately 75% of people with MS. Assistive technology, such as ankle-foot orthosis (AFO) and functional electrical stimulation (FES), increases the safety of  
20 walking and the speed of ambulation (even then, only about one half of patients remain ambulatory 15 years after disease onset). Assistive technology also reduces the risk of injury to the knee and ankle and reduces the effort of ambulation.

Another document (<https://www.resna.org/sites/default/files/legacy/conference/proceedings/2008/SDC2008/Hadley.html>) discloses that “Cerebral Palsy (CP) is a non-progressive  
25 neurological disorder which develops in-utero or after birth. Current treatment for CP includes physical therapy and braces used to increase ambulation. Ankle-Foot Orthoses (AFOs) are lightweight plastic braces that secure the lower leg, ankle, and foot in a predetermined position, commonly used to aide dorsiflexion in CP patients.  
30 another common treatment, Functional Electrode Stimulation (FES), is administered by physical therapists in order to build muscle tone and improve dorsiflexion. FES

5 uses low energy electrical stimulation to excite either the common peroneal nerve or  
the tibialis anterior muscle, causing the patient to actively dorsiflex, increasing foot-  
ground clearance. Our device integrates an FES unit with a hinged AFO, to  
automate and improve the current physical therapy processes used to treat CP  
patients. This allows for the rapid and accurate placement of FES electrodes, which  
10 removes the major barrier to at-home administration of this therapy.

A literature (Walbran et al., *Cogent Engineering* (2016), 3: 1227022  
<http://dx.doi.org/10.1080/23311916.2016.1227022>) discloses neuromuscular  
disorders and injuries such as cerebral palsy and stroke often result in foot-drop  
15 which can result in a person having great difficulty walking. Ankle foot orthoses  
(AFOs) or splints have been prescribed for many years now to limit the range of  
motion of the ankle, provide the patients with support and assist with rehabilitation.  
However the majority of AFOs require a long, labour-intensive manufacturing  
process which results in unacceptable waiting times for children that are rapidly  
20 growing and patients with varying conditions. This research proposes a new  
approach to AFO manufacturing that utilizes digital and additive manufacturing  
technologies to customise the fit and form to an individual. By implementing an  
interchangeable carbon fibre spring at the ankle joint the design will result in a  
stronger, more comfortable, more flexible AFO that can adaptively constrain ankle  
25 movement for various different activities. Three iterations of AFO design have been  
developed and tested to validate their efficacy. A custom machine has been  
designed and constructed in order to empirically test stiffness values for the AFO  
and allow for optimal AFO geometry based on input parameters. This machine has  
proven the structural integrity of the final AFO design. Progress has been made in  
30 automating parts of the design process which will significantly reduce labour  
requirements and hence manufacturing delay times.



5 Another literature (**Mario C. Faustini, Richard R. Neptune\*, Richard H. Crawford, and Steven J. Stanhope, Manufacture of Passive Dynamic Ankle–Foot Orthoses Using Selective Laser Sintering, IEEE TRANSACTIONS ON BIOMEDICAL ENGINEERING, VOL. 55, NO. 2, FEBRUARY 2008**) discloses AFO designs vary in size, shape, and functional characteristics depending on the desired  
10 clinical application. Passive Dynamic (PD) Response ankle–foot orthoses (PD-AFOs) constitute a design that seeks to improve walking ability for persons with various neuromuscular disorders by passively (like a spring) providing variable levels of support during the stance phase of gait. Current PD-AFO manufacturing technology is either labor intensive or not well suited for the detailed refinement of  
15 PD-AFO bending stiffness characteristics. The study was to explore the feasibility of using a rapid freeform prototyping technique, selective laser sintering (SLS), as a PD-AFO manufacturing process. Feasibility was determined by replicating the shape and functional characteristics of a carbon fiber AFO (CF-AFO). The study showed that a SLS-based framework is ideally suited for this application. A second  
20 objective was to determine the optimal SLS material for PD-AFOs to store and release elastic energy; considering minimizing energy dissipation through internal friction is a desired material characteristic. This study compared the mechanical damping of the CF-AFO to PD-AFOs manufactured by SLS using three different materials. Mechanical damping evaluation ranked the materials as Rilsan™ D80  
25 (best), followed by DuraForm™ PA and DuraForm™ GF. In addition, Rilsan™ D80 was the only SLS material able to withstand large deformations.

US8512415 discloses a powered ankle-foot prosthesis, capable of providing human-like power at terminal stance that increase amputees metabolic walking  
30 economy compared to a conventional passive-elastic prosthesis. The powered prosthesis comprises a unidirectional spring, configured in parallel with a force-controllable actuator with series elasticity. The prosthesis is controlled to deliver the high mechanical power and net positive work observed in normal human walking.

US8808214 discloses an Active Ankle Foot Orthosis (AAFO) is provided where the impedance of an orthotic joint is modulated throughout the walking cycle to treat ankle foot gait pathology, such as drop foot gait. During controlled plantar flexion, a biomimetic torsional spring control is applied where orthotic joint stiffness is actively adjusted to minimize forefoot collisions with the ground. Throughout late stance, joint impedance is minimized so as not to impede powered plantar flexion movements, and during the swing phase, a torsional spring-damper (PD) control lifts the foot to provide toe clearance. To assess the clinical effects of variable-impedance control, kinetic and kinematic gait data were collected on two drop foot participants wearing the AAFO. It has been found that actively adjusting joint impedance reduces the occurrence of slap foot, allows greater powered plantar flexion, and provides for less kinematic difference during swing when compared to normal.

US8838263 discloses a computer-controlled fabrication of a patient-specific orthotic device using an automated fabrication machine capable of following computer instructions to create 3D surface contours and new developments in non-invasive three-dimensional (3D) scanning have made it possible to acquire digital models of freeform surfaces such as the surface anatomy of the human body and to then fabricate such a patient-specific device with high precision. Such a patient-specific device brings significant improvement in patient-specific fit, comfort, and function of medical devices (and, in particular, to orthoses that require a close fit to the wearer's body to act effectively). The combination of these two technologies is ideally suited for the development of patient-specific orthotic devices. A patient specific ankle-foot orthotic device using this technology is disclosed. This exemplary device is used to help stabilize the ankle-foot region, for example, in patients with impaired gait.

5 None of the document suggests a hot and cold pouch unit in AFO and FES system for improving foot drop of strokes, multiple sclerosis, cerebral palsy patients, and common peroneal nerve injury patients.

The existing document failed to suggest the adhesive electrode in AFO and FES  
10 system for improving foot drop of strokes, multiple sclerosis, cerebral palsy patients, and common peroneal nerve injury patients.

### **OBJECT OF THE INVENTION**

It is an objective of the invention is to provide a customised ankle foot orthotic  
15 device with an effective hot and cold pouch unit for improving foot drop of a patient selected from strokes, multiple sclerosis, cerebral palsy patients and common peroneal nerve injury.

It is another objective of the invention is to provide a customised ankle foot orthotic device with novel adhesive electrode for the treatment of foot drop.

20 It is yet another objective of the invention is to provide a customised ankle foot orthotic device with novel adjustable strap for the treatment of foot drop.

It is yet another objective of the invention is to provide a novel customised foot orthotic device for improving gait and rehabilitation.

25 It is yet another objective of the invention is to provide a cost effective and easy to use orthotic device for foot drop problem.

It is yet another objective of the invention is to provide a device that could reduce the pain as compared to conventional AFO while treating foot drop.

30

It is further objective of the invention is to increase the speed of a foot drop patient in treadmill using the device.

5 **SUMMARY OF THE INVENTION**

According to first aspect of the invention, there is provided a customised ankle foot orthotic device consist of

- calf piece (1);
  - 10 calf strap (2);
  - a muscle stimulator (3);
  - stimulator suspension (4) includes a press button with nylon strap;
  - two adhesive electrodes (5);
  - electrical wires (6);
  - 15 hinge joint (7);
  - JBR outsole (8);
  - foot piece (9);
  - ankle strap (10);
  - forefoot strap (11);
  - 20 ring (12.2 and 12.3);
  - adjustable strap (13);
  - press button (14);
  - cold and hot pack pouch (15)
  - a means to provide upward projection (16); &
  - 25 shank (17);
- charecterized in that the adhesive strap being mounted on the the rings (12.2 and 12.3) so as to keep the plantar section of the foot piece (9) in straight position and
- wherein the adhesive strap being made up by a combination of polyvinyl chloride, polypropylene and polyethylene
- 30 wherein polyvinyl chloride, polypropylene and polyethylene is 1:1:2 by weight;

5 wherein the cold and hot pack pouch being made up of 40.5 wt% water; 40.5 wt% ammonium nitrate, 4 wt% hydropropylmethyl cellulose and 15 wt% propylene glycol; and

wherein the said electrode being made up of a hydrogel comprises of acrylic acid and N-vinylpyrrolidone.

10 In accordance with these and other objects which will become apparent hereinafter, the instant invention will now be described with particular reference to the accompanying drawing.

### **BRIEF DESCRIPTION OF THE ACCOMPANYING DRAWINGS**

15 Figure 1a schematically illustrates the customised ankle foot orthotic device in accordance with the present invention;

Figure 1b schematically illustrates the side view of the device in accordance with the present invention;

20 Figure 1c schematically illustrates the front view of the device in accordance with the present invention;

Figure 1d schematically illustrates the rear view of the device in accordance with present invention; &

25 Figure 2 is the visual analogue scale for the measure of pain in accordance with the present invention.

Other objects, features and advantages of the inventions will be apparent from the following detailed description in conjunction with the accompanying drawings of the inventions.

### **DETAILED DESCRIPTION OF THE PREFERRED EMBODIMENT:**

30 **Expression:**

5 The following term as used in the invention is defined:

Ankle Foot Orthosis (AFO): It is a device applied to the ankle for modifying functional characteristics of neuromuscular conditions.

10 Electrical Stimulator: It is an electrical device which is used for stimulating impaired structures in neuromuscular conditions and for improving strength in weak muscles.

Range Of Motion (ROM): It is a linear or angular distance that a moving object normally travels while properly attached to other. Usually it ranges or flexion and extension. Alternatively, the range of motion is defined as it is the measurement of movement around a specific joint. The range of motion is denoted by “degree”.

Foot Drop: It is the neuromuscular condition in which the muscles or nerve which are supplying to the foot are paralysed and is unable to lift the foot while walking it is called as Foot Drop.

20 Spasticity: It is the condition in which muscles get stiff and tight.

Stroke: It is medical condition in which there is poor blood supply to brain which may result in cell death due to interruption of blood flow there is damage to brain. Stroke caused by blocked artery or bursting of blood vessels. Due to this, brain is not functioning properly which may lead to improper body functioning.

30 Multiple Sclerosis: It is potentially disabling disease of brain and spinal cord. In multiple sclerosis the immune system attacks the protective sheath (myelin) that covers nerve fiber and causes communicating problem between the brain and rest of body.

Cerebral Palsy: It is a congenital disorder of movement muscle tone and posture that appear in early childhood.

5 Visual analog scale (VAS): It is a psychometric response scale which can be used in questionnaires. It is a measurement instrument for subjective characteristics or attitudes that cannot be directly measured. When responding to a VAS item, respondents specify their level of agreement to a statement by indicating a position along a continuous line between two end-points.

10 The present invention provides a customised ankle foot orthotic device for improving foot drop of a patient selected from strokes, multiple sclerosis, cerebral palsy patients and common peroneal nerve injury. The device (Figure 1a-1d) of the present invention consist of

1. Calf piece;
- 15 2. Calf strap;
3. Portable Muscle stimulator;
4. Stimulator suspension consisting of press button with nylon strap;
5. Adhesive electrode;
6. Electrical wires;
- 20 7. 2D hinge joint consisting of 4mm MS nut and bolt;
8. JBR outsole;
9. Foot piece;
10. Ankle strap;
11. Forefoot strap;
- 25 12. Ring;
13. Adjustable strap;
14. Press button;
15. Cold and Hot pack pouch;
16. Upward projection; &
- 30 17. Shank;

5 Referring to Figure 1a-1d, the orthosis of the present invention mainly consists of two sections: a Calf piece (1) and a Foot (9) which are articulately joined on each side of the ankle by two hinge joint of MS nuts and Bolts (7). The calf piece comprises a calf strap with an upper portion which may be wrapped around the patient's calf and secured by a velcro strap (2). The strap is attached to one side of the greave while the other end is free and is designed to loop around the calf. Below  
10 the strap (2), there is a stimulator suspension (4) which consists of press buttons in which portable muscle stimulator (3) is mounted. The greave extends downward from the calf area (1) to forward narrow shank (17) below which the greave broadens at ankle area to match the contour of the ankle. The plantar section (9)  
15 has a JBR (Johnson bros rubber) outsole (8) and an upward project on (16) which intimately wraps around heel & ankle areas of the patient. The hinge joints (7) are mounted loosely so that a plantar section (9) can rotate upward around the axis delineated by the two hinge (7). This movement of plantar section (9) provides for dorsiflexion of foot during the swing phase of gait cycle. The downward movement  
20 of plantar section (9) is stopped when the upper edge of the projection (16) comes in contact with the on the inner side of greave (2) thus, preventing the foot drop. The two sections (1) and (9) of the present device are made from thin-sheeted polypropylene material which are designed so as to counter the shape of the objects leg and foot. Ankle strap (10) is looped around the ring ankle (12.1) so as to  
25 fasten the strap tightly around the ankle. Forefoot strap (11) which is looped around the forefoot so as to fasten the strap tightly around the forefoot. Adjustable straps (13) is mounted on respective side by a ring (12.2) & (12.3) for keeping plantar section (9) in a stretched position.

Electrical muscle stimulator (3) consist of two adhesive electrodes (5) attached by  
30 electrical wire (6). Pouch (15) which is the inner aspect of calf piece of AFO includes cold and hot pack. All the straps herein are embedded by press buttons  
All straps are embedded by press buttons (14).



5 **Adhesive electrode:**

The self-adhesive hydrogel electrodes (5) according to present invention is prepared by the method as given in **Keller et al., Electrodes for transcutaneous (surface) electrical stimulation, JOURNAL OF AUTOMATIC CONTROL, UNIVERSITY OF BELGRADE, VOL. 18(2):35-45, 2008** except the amount of acrylic acid and N-vinylpyrrolidone which is 1:2 by weight in the present invention. The impulses are generated by the device and are delivered through electrodes on the skin near to the muscles being stimulated. The electrodes are generally pads that adhere to the skin. The impulses mimic the action potential that comes from the central nervous system, causing the muscles to contract.

15

**Hot and cold pouch:**

The hot and cold pouch according to present invention is prepared by the method disclosed in **US4462224**:

**Table 1**

Formulation code	Gel formulation					
	Water solvent	Solute	Gelling agent	Wetting agent	-23°C to 10°C, Time	Ambient Viscosity
G-1						
G-2	35 wt. %	35 wt. % NH <sub>4</sub> NO <sub>3</sub>	5wt% F4M Methocel	25wt% propylene glycol	15 minutes	>1,000,000 centipoise
G-3	42.5 wt. %	42.5 wt. % NH <sub>4</sub> NO <sub>3</sub>	5wt% F4M Methocel	10wt% propylene glycol	31 minutes	273,000 centipoise

G-4	41,83 wt %	41.83 wt. % NH <sub>4</sub> NO <sub>3</sub>	5wt% F4M Methocel	12.33wt% propylene glycol	29 minutes	>1,000,000 centipoise
G-5	40.5 wt. %	40.5 wt. % NH <sub>4</sub> NO <sub>3</sub>	5wt% F4M Methocel	15wt% propylene glycol	25.6 minutes	563,000 centipoise
G-6	40 wt. %	40 wt. % NH <sub>4</sub> NO <sub>3</sub>	5wt% F4M Methocel	15wt% propylene glycol	21 minutes	>1,000,000 centipoise
G-7	37.5 wt. %	37.5 wt. % NH <sub>4</sub> NO <sub>3</sub>	5wt% F4M Methocel	20wt% propylene glycol	13.5 minutes	>1,000,000 centipoise
G-8	40 wt. %	40 wt. % NH <sub>4</sub> NO <sub>3</sub>	5wt% F4M Methocel	15wt% ethanol	17 minutes	>1,000,000 centipoise
G-9	40 wt, %	40 wt. % NH <sub>4</sub> NO <sub>3</sub>	5wt% SGP	15wt% propylene glycol	19 minutes	183,000 centipoise
G-10	40 wt. %	40 wt. % NH <sub>4</sub> NO <sub>3</sub>	5wt% gum tragacant	15wt% propylene glycol	16.5 minutes	170,000 centipoise
G-11	40 wt. %	40 wt. % NH <sub>4</sub> NO <sub>3</sub>	5wt% guar gum	15wt% propylene glycol	18.3 minutes	>1,000,000 centipoise
G-12	43.75 wt. %	31,25 wt. % NH <sub>4</sub> NO <sub>3</sub>	5wt% F4M Methocel	20wt% propylene glycol	11 minutes	>1,000,000 centipoise

G-13	51,33 wt, %	28.66 wt. % NH <sub>4</sub> NO <sub>3</sub>	5wt% F4M Methocel	15wt% propylene glycol	19.5 minutes	>1,000,000 centipoise
G-14	40 wt. %	28 wt.% CO(NH <sub>2</sub> ) <sub>2</sub>  and 12 wt. % KCl	5wt% F4M Methocel	15wt% propylene glycol	11 minutes	>1,000,000 centipoise
G-15	37.5 wt. %	37.5 wt. % NH <sub>4</sub> NO <sub>3</sub>	5wt% F4M Methocel	20wt% metahnol	11.5 minutes	780,200 centipoise

5      Wherein Methocel: Hydroxypropyl methyl cellulose

**Adjustable strap:**

The self adjusted strap herein is used for stretching purposes in which specific muscle or tendon (or muscle group) is deliberately flexed or stretched in order to improve the muscle's felt elasticity and achieve comfortable muscle tone. The result is a feeling of increased muscle control, flexibility, and range of motion. A combination of polyvinyl chloride:polypropylene:polyethylene 1:1:2 by weight according to the present invention is used for making the strap. The orthotic device of the present invention improves the gait and rehabilitation ,in previously used orthosis there were not active dorsiflexion which is very important for gait training and rehabilitative purposes we just have to wear and do gait training ,thus our device is doing dorsiflexion of ankle with the help of functional electrical stimulation through adhesive pads which is fitted on tibialis anterior muscle,this will also gives feedback.

The customised ankle foot orthotic device according to the present invention increases the speed of a foot drop patient in treadmill as compared to conventional AFO.

5 The invention is now illustrated by non-limiting examples.

**Example 1:**

Preparation of the hot and cold pouch unit and the adhesive hydrogel:

All the materials like the solute, solvent, gelling agent, wetting agent & other parameters as in Table 1, was purchased from the local market, Mumbai and prepared the gel formulation following the method disclosed in US4462224. 20 g of the gel was incorporated into the pouch for the purpose of treatment.

The adhesive electrode was prepared by the method disclosed in Keller et al in which the amount of acrylic acid and N-vinylpyrrolidone which is 1:2 by weight.

Experimental trials:

15 The experimental trial as to evaluate the efficacy of the present device for foot drop, was conducted in **Krishna Institute of Physiotherapy, near Dhebewadi Road, Malkapur, Karad, Pin code- 415110, Maharashtra, India.**

10 NOS patient whose average weight of 40-70 either gender, was selected for the following each groups:

20 Goup-I: strokes;

Goup-II: multiple sclerosis;

Goup-III: cerebral palsy patients; &

Goup-III: common peroneal nerve

25 **Following were the steps to set the device to the patient:**

Turn on the intensity:

5 After the electrodes were placed firmly on skin and the lead wires are plugged in the socket of device, turn the ON/ OFF control clockwise. The menu will reveal on LCD.

Select mode:

10 There were two EMS modes of option, S (synchronous) or A (alternate) .Select a mode by pressing the mode control when a EMS mode is selected, the LCD shows EMS on the top. After a mode is selected, press SET control to enter next setting. The patient may adjust the setting only when it is flashing and then press the increment or decrement control to change the settings.

15

Set Ramp Time:

The ramp time controls the time of output current that increase from 0 to the setting level, and from the setting value to 0. When the ramp time was set, each contraction was ramped up and down in order that the signals come on and come off gradually and smoothly. The ramp time was adjustable from 1 to 8 seconds.

Set ON time:

25 The On Time controls the time of stimulation. By pressing the “SET” control, the contraction time can be adjusted. Both channels stimulation was cycled on and off by the contraction and relaxation settings. The\_range is\_adjustable\_ from 2 seconds to 90 seconds.

As the “ON” time including the ramp up and ramp down time, the setting of it should be no less than two times of the “RAMP” time.

30

Set OFF time:

5 The off times controls the time of relaxation. By pressing the “SET” control , the relaxation time can be adjusted. Both channels stimulation is cycled on and off by the contraction and relaxation settings. The range ios adjustable from 0 second to 90 seconds.

In alternate mode, the OFF time should be equal or more than the ON time.

10

#### Set Pulse Width:

Pulse Width was adjustable from 50 us to 300 us. Press “SET” control to enter this menu, the press “Increment or Decrement” to adjust the setting. If no instructions  
15 regarding the pulse width are given in therapy, set the control to the suggested 70-120 us setting.

#### Set Pulse Rate:

20 Pulse rate was adjustable from 2Hz to 150Hz. Press “SET” control to enter this menu, then press “Increment or Decrement” to adjust the setting. Unless otherwise instructed, turn the pulse rate control to the 70-120 range.

#### Set Timer:

25

The treatment time was adjustable from 1 to 60 minutes or C (continuous). Press “SET” control to enter this menu, then press “Increment” or “Decrement” to adjust the setting. Press “Increment” control when the timer shows 60 minutes, it was switched to continuous stimulation.

30

#### Compliance Meter:

This unit can store 60 sets of operation records. Total treatment time up to 999 hours can be stored.

5 Check and Delete individual record:

Press “MODE” control and turn on the power simultaneously. The LCD display shows the number of records and operation time. Press the “increment” and “decrement” button to each record. After all set then train the patient on flat surface with customized dynamic orthosis, and then make him to walk on treadmill with obstacles placing between them.

10

Comparative study of customised ankle foot orthotic device with or without hot & cold unit and adjustable strap for range of motion:

15

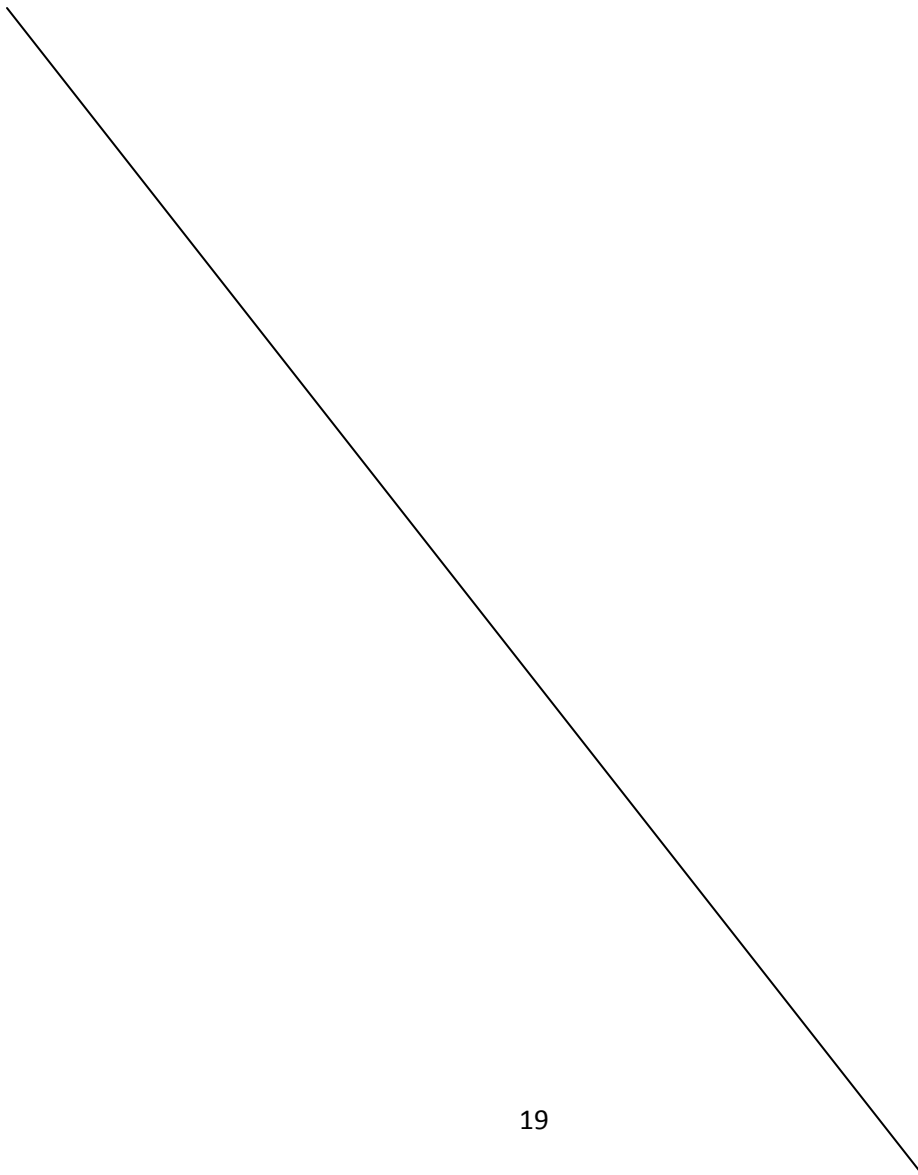

**Table 2**

Sr. No.	Pre-treatment# (i.e. without customised ankle foot orthotic device) (ROM)	Post-treatment# i.e. with customised ankle foot orthotic device BUT without hot and cold unit and adjustable strap (ROM) (CE)	Post-treatment i.e. with customised ankle foot orthotic device WITH hot and cold unit (G1-G15) and the adjustable strap P:P:P 1:1:2 (ROM)															Post treatment with G4 & adjustable strap P:P:P 1:1:1 (ROM) (CE)
			G1 (CE)	G2 (CE)	G3 (CE)	G4 <b>(IE)</b>	G5 (CE)	G6 (CE)	G7 (CE)	G8 (CE)	G9 (CE)	G10 (CE)	G11 (CE)	G12 (CE)	G13 (CE)	G14 (CE)	G15 (CE)	
1	5°	15°	17°	19°	17°	25°	16°	15°	18°	19°	18°	17°	19°	19°	17°	15°	16°	20°
2	10°	20°	20°	20°	21°	35°	21°	19°	19°	20°	19°	19°	20°	21°	19°	18°	20°	21°



3	9°	15°	15°	16°	22°	30°	23°	18°	21°	19°	18°	17°	22°	19°	21°	21°	22°	24°
4	15°	18°	19°	18°	20°	40°	22°	17°	19°	19°	20°	19°	22°	20°	20°	18°	22°	21°
5	18°	22°	22°	21°	24°	45°	20°	21°	21°	21°	21°	20°	21°	21°	22°	19°	21°	18°
6	20°	14°	14°	16°	15°	42°	19°	19°	22°	18°	17°	19°	20°	17°	16°	21°	20°	20°
7	8°	16°	16°	20°	20°	35°	21°	16°	20°	21°	19°	16°	21°	20°	19°	19°	20°	20°
8	10°	17°	17°	19°	21°	40°	21°	19°	21°	19°	17°	19°	21°	17°	21°	20°	21°	19°
9	14°	19°	20°	20°	19°	38°	19°	20°	23°	20°	21°	21°	20°	23°	20°	21°	20°	19°
10	13°	18°	18°	20°	20°	40°	19°	18°	19°	19°	19°	21°	19°	19°	18°	17°	18°	19°

5    Wherein #: Measurement was done with the help of goniometer

CE: Comparative example;

IE: Inventive example; &

P:P:P = polyvinyl chloride:polypropylene:polyethylene

10    Table 2 shows the superior effect of hot and cold unt made up of the gel formulation G4 (40.5% water; 40.5% NH<sub>4</sub>NO<sub>3</sub>, 4% F4M Methocel, 15% propylene glycol) and adjustable strap made up of a combination of polyvinyl chloride:polypropylene:polyethylene 1:1:2 while evaluating range of motion (ROM) in foot drop of a stroke patient.

5

Accordingly, hot & cold pack unit (15) made up of G4 (40.5% water; 40.5%  $\text{NH}_4\text{NO}_3$ , 4% F4M Methocel, 15% propylene glycol) and adjustable strap (13) made up of a combination of polyvinyl chloride:polypropylene:polyethylene 1:1:2 both were selected for further studies.

10-meter walk test:

The present device was evaluated by 10-meter walk test and the results were noted in metres/second. The individual was walked without assistance for 10 metres, with the time measured for the intermediate 6 metres to allow for acceleration and deceleration. Assistive devices may be used, but must be kept consistent and documented for each test. Count the start time when the toes pass the 2 metre mark and stopping time when the toes pass the 8 metre mark. It can be tested at either preferred walking speed or maximum walking speed (ensure to document which was tested). This test was performed for each group of disease three times and calculated the average of the same.

Visual analogue scale/Graphic rating scale:

As shown in Figure 2, the Visual Analogue Scale (VAS) or Graphic Rating Scale was first used in psychology by Freyd in 1923, consists of a straight line with the endpoints defining extreme limits such as 'no pain at all' and 'pain as bad as it could be'. The patient was asked to mark his pain level on the line between the two endpoints. The distance between 'no pain at all' and the mark then defines the subject's pain as 0-3.99 as mild; 4-6.99 as moderate and 7-10 as severe.

**Table 3: Group I (Stroke patients)**

Sr. No.	Patients age	10 meter walk test SPEED (metres/sec)		Visual analogue scale	
		Customised ankle foot orthotic device <b>(Inventive example)</b>	Conventional AFO# <b>(Comparative example)</b>	Conventional AFO# <b>(Comparative example)</b>	Customised ankle foot orthotic device <b>(Inventive example)</b>

					<b>example)</b>
1	40	0.97	0.71	8	2
2	45	0.99	0.68	7	2
3	55	0.97	0.73	9	1
4	60	0.99	0.65	6	2
5	58	0.98	0.73	6	1
6	59	0.99	0.69	7	4
7	53	0.94	0.72	8	4
8	54	0.98	0.76	9	1
9	55	0.98	0.70	8	3
10	45	0.92	0.68	9	4

# conventional AFO was prepared with the same components as in present device but WITHOUT the adhesive electrode (5), the hot & cold pack unit (15) and adjustable strap (13). Silicone electrode was used in the conventional AFO.

**Table 4: Group II (multiple sclerosis)**

Sr. No.	Patients age	10 meter walk test SPEED (metres/sec)		Visual analogue scale	
		Customised ankle foot orthotic device <b>(Inventive example)</b>	Conventional AFO# <b>(Comparative example)</b>	Conventional AFO# <b>(Comparative example)</b>	Customised ankle foot orthotic device <b>(Inventive example)</b>

					<b>example)</b>
1	55	0.98	0.69	9	1
2	45	0.96	0.70	6	2
3	56	0.89	0.73	7	4
4	95	0.99	0.75	8	1
5	58	0.96	0.68	9	3
6	65	0.98	0.78	6	2
7	40	0.97	0.77	5	1
8	42	0.94	0.71	8	3
9	49	0.96	0.77	7	4
10	54	0.94	0.74	8	2

# conventional AFO was prepared with the same components as in present device but WITHOUT the adhesive electrode (5), the hot & cold pack unit (15) and adjustable strap (13). Silicone electrode was used in the conventional AFO.

**Table 5: Group III (cerebral palsy patients)**

Sr. No.	Patients age	10 meter walk test SPEED (metres/sec)		Visual analogue scale	
		Customised ankle foot orthotic device <b>(Inventive)</b>	Conventional AFO# <b>(Comparative example)</b>	Conventional AFO# <b>(Comparative example)</b>	Customised ankle foot orthotic device

		example)			(Inventive example)
1	14	0.85	0.65	5	2
2	15	0.89	0.68	7	3
3	25	0.90	0.70	6	1
4	21	0.87	0.68	9	2
5	11	0.90	0.69	4	1
6	25	0.91	0.65	7	1
7	18	0.92	0.66	5	3
8	14	0.85	0.68	6	1
9	19	0.86	0.70	3	2
10	12	0.87	0.75	2	1

# conventional AFO was prepared with the same components as in present device but WITHOUT the adhesive electrode (5), the hot & cold pack unit (15) and adjustable strap (13). Silicone electrode was used in the conventional AFO.

**Table 6: Group IV (common peroneal nerve)**

Sr. No.	Patients age	10 meter walk test SPEED (metres/sec)		Visual analogue scale	
		Customised ankle foot orthotic device	Conventional AFO# <b>(Comparative</b>	Conventional AFO# <b>(Comparative</b>	Customised ankle foot orthotic

		(Inventive example)	example)	example)	device (Inventive example)
1	25	1.02	0.85	7	3
2	18	1.05	0.89	8	2
3	42	1.50	0.90	9	2
4	35	0.99	0.78	6	3
5	28	1.23	0.91	8	1
6	45	1.7	0.86	5	2
7	54	1.56	0.87	7	3
8	52	1.22	0.83	8	2
9	70	1.23	0.92	7	1
10	22	1.11	0.89	9	2

# conventional AFO was prepared with the same components as in present device but WITHOUT the adhesive electrode (5), the hot & cold pack unit (15) and adjustable strap (13). Silicone electrode was used in the conventional AFO.

Table 3-6 showed the superior effect of customized ankle foot orthotic device as compared to conventional AFO in view of both 10-meters walk test and the visual analogue scale for different diseases conditions.

Although the foregoing description of the present invention has been shown and described with reference to particular embodiments and applications thereof, it has been presented for purposes of illustration and description and is not intended to be exhaustive or to limit the invention to the particular embodiments and applications

disclosed. It will be apparent to those having ordinary skill in the art that a number of changes, modifications, variations, or alterations to the invention as described herein may be made, none of which depart from the spirit or scope of the present invention. The particular embodiments and applications were chosen and described to provide the best illustration of the principles of the invention and its practical application to thereby enable one of ordinary skill in the art to utilize the invention in various embodiments and with various modifications as are suited to the particular use contemplated. All such changes, modifications, variations, and alterations should therefore be seen as being within the scope of the present invention as determined by the appended claims when interpreted in accordance with the breadth to which they are fairly, legally, and equitably entitled.



## **I Claim,**

1. A customised ankle foot orthotic device consist of

calf piece (1);

calf strap (2);

a muscle stimulator (3);

stimulator suspension (4) includes a press button with nylon strap;

two adhesive electrodes (5);

electrical wires (6);

hinge joint (7);

a rubber outsole (8);

foot piece (9);

ankle strap (10);

forefoot strap (11);

ring (12.2 and 12.3);

adjustable strap (13);

press button (14);

cold and hot pack pouch (15)

a means to provide upward projection (16); &

shank (17);

characterized in that the adhesive strap being mounted on the the rings (12.2 and 12.3) so as to keep the plantar section of the foot piece (9) in straight position and

wherein the adhesive strap being made up by a combination of polyvinyl chloride, polypropylene and polyethylene

wherein polyvinyl chloride, polypropylene and polyethylene is 1:1:2 by weight;

wherein the cold and hot pack pouch being made up of 40.5 wt% water; 40.5 wt% ammonium nitrate, 4 wt% hydropropylmethyl cellulose and 15 wt% propylene glycol; and

wherein the said electrode being made up of a hydrogel comprises of acrylic acid and N-vinylpyrrolidone.

2. The customised ankle foot orthotic device as claimed in claim 1, wherein the ratio of acrylic acid and N-vinylpyrrolidone is 1:2 by weight.
3. The customised ankle foot orthotic device as claimed in claim 1, wherein the downward movement of plantar section (9) is stopped when the upper edge of the projection (16) comes in contact with the inner side of greave (2).
4. The customised ankle foot orthotic device as claimed in claim 1, wherein the calf piece (1) and foot piece (9) is made up of polypropylene material.
5. The customised ankle foot orthotic device as claimed in claim 1, wherein the straps are embedded by the press botton (14).
6. The customised ankle foot orthotic device as and when used for foot drop of the disease condition selected from a group consisting of strokes, multiple sclerosis, cerebral palsy or common peroneal nerve injury.

Dated this 29<sup>th</sup> day of March, 2019

*Arghya Roy*

(Arghya Ashis Roy)  
Patent Agent (IN/PA 2346)  
Of Lex-Regia  
For the Applicant

To,  
The Controller of Patents,  
The Patent Office  
Mumbai

## **ABSTRACT**

### **“CUSTOMISED ANKLE FOOT ORTHOTIC DEVICE”**

A customised ankle foot orthotic device consist of calf piece (1); calf strap (2); a muscle stimulator (3); stimulator suspension (4) includes a press button with nylon strap; two adhesive electrodes (5); electrical wires (6); hinge joint (7); JBR outsole (8); foot piece (9); snkle strap (10); forefoot strap (11); ring (12.2 and 12.3); adjustable strap (13); press button (14); cold and hot pack pouch (15); a means to provide upward projection (16); & shank (17); charecterized in that the adhesive strap being mounted on the the rings (12.2 and 12.3) so as to keep the plantar section of the foot piece (9) in straight position and wherein the adhesive strap being made up by a combination of polyvinyl chloride, polypropylene and polyethylene wherein polyvinyl chloride, polypropylene and polyethylene is 1:1:2 by weight; wherein the cold and hot pack pouch being made up of 40.5 wt% water; 40.5 wt% ammonium nitrate, 4 wt% hydropropylmethyl cellulose and 15 wt% propylene glycol; and wherein the said electrode being made up of a hydrogel comprises of acrylic acid and N-vinylpyrrolidone. Figure (1a-1d)

## Transfer of Technology Agreement

This Transfer of Technology Agreement (hereinafter referred to as "ToT") is made at Krishna Institute of Medical Sciences "Deemed to be University" (KIMSDU), Karad for the transfer of technology entitled "A device for physically restraining movement" and "An injection guide" developed by KIMSDU, Karad. This Technology Transfer ("ToT") Agreement made and entered into on this 7<sup>th</sup> day of January, 2020.

### BETWEEN

**Krishna Institute of Medical Sciences** "Deemed to be University", Karad ("KIMSDU"), through the Registrar, hereinafter referred to as "First Party"

### AND

**Paradise Plastic Molding Works**, Karad through Proprietor Mr. Dhiraj Patil, hereinafter referred to as "Second Party".

WHEREAS the KIMSDU is an recognized Medical "Deemed to be university", accredited by NAAC with A grade, an ISO 9001:2015 certified University and is accredited by various reputed National and International bodies, having education and research expertise in the field of medical, paramedical, nursing, pharmaceutical and allied sciences.

WHEREAS the Paradise Plastic Molding Works is involved in the manufacturing and marketing of biomedical products and an authorized registered company.

AND WHEREAS both the parties KIMSDU and Paradise Plastic Molding Works desire to spell out the terms and conditions in respect of this collaboration and to enter into a Technology Transfer (ToT) Agreement for that purpose.

### NOW IT IS AGREED BY AND BETWEEN THE PARTIES AS UNDER

#### 1. SCOPE/TERMS OF COLLABORATION

- 1.1. The ToT agreement entitled to provide all the technical details about product on as is where is basis in order to achieve smooth manufacturing practices (details given in patent literature) and startup.
- 1.2. The charges for authentication and certifications of the product from competent authority shall be paid by "First party".
- 1.3. The second party shall not alter or dilute the quality of product as per the specifications made under the document of ToT which has been authenticated and approved by competent authorities (Controller of Patent).
- 1.4. The first party shall not enter into the manufacturing or marketing of the product directly or indirectly.
- 1.5. The first party shall grant the design details of ToT agreement to the second party after the signing of this ToT agreement.

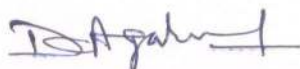

Add. Director of Research  
KIMSDU, Karad

- 1.6. Any kind of breach in the conditions which has been mentioned in this document shall amount to withdrawal of this agreement by First party.

## 2. INTELLECTUAL PROPERTY RIGHTS AND PUBLICATIONS (IF ANY)

- 2.1 Notwithstanding anything contained to the contrary, the entire rights, title and interest in any intellectual property including but not limited to patent and publications emerging out of the collaborative research to be carried out under this ToT ("IP") agreement, will be jointly owned by both the parties, if it is during the research and Development work.
- 2.2 The exclusive right of business and product development out of the patent, development will remain with both the parties and in case of second party after authenticity transferring for commercialization and licensing which shall be covered by separate agreement for royalty distribution.

## 3. CONFIDENTIALITY

- 3.1 The term "Confidential Information" shall mean any information disclosed by one party ("Discloser") to the other ("Receiver"), pursuant to this ToT agreement or otherwise, which is in written, graphic, machine readable or other tangible form and is marked as 'Confidential' or 'Proprietary' or in some other manner to indicate its confidential nature. Confidential information may also include oral information disclosed by one party to the other, pursuant to this ToT agreement, provided that such information is designated as Confidential at the time of disclosure and reduce to a written summary by the disclosing party, within 30 days after its oral disclosure, which is marked in a manner to indicate its confidential nature and delivered to the receiving party.
- 3.2 For the term of this ToT agreement, each party, shall treat as confidential all confidential information of the other party, shall not use such confidential information except as expressly set forth herein or otherwise authorized in writing, shall implement reasonable procedures to prohibit the disclosure, unauthorized duplication, misuse or removal of the other parties confidential information and shall not disclose such confidential information to any third party except as may be necessary and required in connection with the rights and obligations of such party under this ToT agreement. Without limiting the foregoing, each of the parties shall use at least the same procedures and degree of care which it uses to prevent the disclosure of its own confidential information of like importance to prevent the disclosure of confidential information disclosed to it by the other party under this ToT agreement.

### 4.3 Confidential information shall not include the information which,

- i) was generally known and available at the time it was disclosed or becomes generally known and available through no fault of the

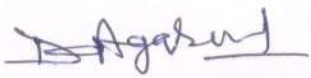
  
Add. Director of Research  
KIMSDU, Karad

receiver, was known to the recipient of such information, without restriction, at the time of disclosure as shown by the files of the recipient in existence at the time of disclosure,

- ii) is disclosed with the prior written approval of the disclosure,
- iii) was independently developed by the receiver without any use of the confidential information, and by employees and other agents of the receiver who have not been exposed to the confidential information, provided that the receiver can demonstrate such independent development by documented evidence prepared contemporaneously with such independent development.
- iv) becomes known to the receiver, without restriction, from a source other than the discloser without breach of this ToT agreement by the receiver and otherwise, not in violation of the discloser's rights.
- v) In addition, each party shall be entitled to disclose the other parties confidential information to the extent such disclosure is requested by the order or requirement of a Court, administrative agency, or other governmental body, provided that the party required to make the disclosure shall provide prompt and advance notice thereof, to enable the other party to seek a protective order or otherwise prevent such disclosure.

#### **5. RELATIONSHIP OF THE PARTIES**

Nothing in this ToT agreement is intended to create a partnership, joint venture or other form of relationship between the Parties. Neither party makes any representations or warranties, whether express or implied. Neither party shall be liable to other for any indirect, consequential or any damages, whatsoever.

#### **6. EFFECTIVE DATE AND DURATION OF THE TOT AGREEMENT**

This ToT agreement is made for startup of the products invented/patented by first party and shall be valid till pilot study and survey of market feasibility. However the further actions involved in commercialization shall be governed by separate agreement.

#### **7. AMENDMENT TO TOT AGREEMENT**

No amendment to this ToT agreement shall be valid unless the same is made in writing jointly by the parties hereto or their authorized representatives and specifically stating the same to be an amendment to this ToT agreement.

#### **8. TERMINATION OF TOT AGREEMENT**

- 8.1 The ToT agreement shall not be terminated by first and second party during ongoing financial year.

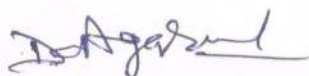

**Add. Director of Research**  
KIMSDU, Karad

- 8.2 This ToT agreement can be terminated by any party giving the other party, a prior written notice of not less than 60 days of its intention to do so but without dishonoring any commitment entered into prior to the date of termination notice.
- 8.3 Despite termination, the parties shall abide by the usual professional ethics and normal code of conduct to maintain the confidentiality of the information and any IPRs.

## 9. SETTLEMENT OF DISPUTES

Any dispute arising in relation to or in connection with this ToT agreement between the parties shall be resolved by mutual negotiations. In case of any unresolved dispute, the parties shall refer the said dispute for arbitration, to the sole arbitrator appointed by all the Parties and the decision of the arbitrator shall be final and binding on all the three parties. The provisions of Arbitration and Conciliation Act, 1996 shall apply to such arbitration. Such arbitration proceeding shall be held at Satara Jurisdiction.

IN WITNESS WHEREOF the parties hereby execute this Agreement on the day and year first above written.

For KIMSDU

  
-----

Authorized Signatory  
Name: Dr. M. V. Ghorpade  
Designation: Registrar  
Date: 07/01/2020

Witness for KIMSDU

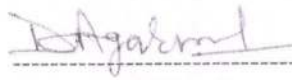
  
-----

Authorized Signatory  
Name: Dr. D.K. Agarwal  
Designation: Additional Dir. Research  
Date: 07/01/2020

  
-----

Authorized Signatory  
Name: Dr. Rohan S. Phatak  
Designation: Jr. Research Officer  
Date: 07/01/2020

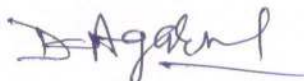
  
-----

Add. Director of Research  
KIMSDU, Karad



For Paradise Plastic Molding Works

  
-----

Authorized Signatory  
Name: Mr. Dhiraj Patil  
Designation: Proprietor  
Date: 07/01/2020

Witness for Paradise Plastic Molding Works

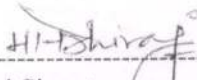
  
-----

Authorized Signatory  
Name: Mr. D.A. Mane  
Designation: Statistician  
Date: 07/01/2020

  
-----

Authorized Signatory  
Name: Mr. Mahendra Alad  
Designation: Stationary  
Date: 07/01/2020



**FORM-2**

THE PATENTS ACT, 1970

(39 OF 1970)

&

THE PATENT RULES, 2003

**COMPLETE SPECIFICATION**

(SECTION 10, RULE 13)

**TITLE**

“A DEVICE FOR PHYSICALLY RESTRAINING MOVEMENT”

**APPLICANT**

SUNITA HOSHEDAR TATA,

an Indian National,

Krishna Institute of Medical Sciences and Krishna Hospital,

near Dhebewadi Road, Malkapur, Karad, Pin code- 415110,

Maharashtra, India

The following specification particularly describes the nature of the invention and the manner in which it is to be performed



## **FIELD OF THE INVENTION**

The present invention relates to a medical device. More particularly, the present invention relates to a device which can physically restrain the movement of a patient who is non-cooperative.

## **5 BACKGROUND OF THE INVENTION**

In medical field, the restraints are often used to help ensure patient and staff safety for example physical restraint, mechanical restraint, chemical restraint, psychological restraint. Out of this the more suitable restraint in medical science is physical restraint. The physical restraint has many uses for instance physically  
10 restraining a patient during surgical procedures is utilized to place the patient in a proper surgical position, and to avoid sudden involuntary movements during surgery. Restraining devices are also used in psychological facilities to help restrict patients from injuring themselves or the others. It can be also used to control difficult or unpredictable patients during transport. In short physical restraints are  
15 used for patients who are assessed to be in extreme danger of injury to themselves and others.

Mechanical appliances, material or equipment attached to the patient's body that he/she cannot easily remove themselves, restricting movement or normal access to one's body. There are a Restraint standards, Regulations and policies (Hospital  
20 Restraint Policies, Dr. Richard Griffiths and Dr. Nicholas Love, Imperial College Healthcare, AAGBI Position Statement, September 2013) to be followed, as the use of Restraint has been found to be sometimes unnecessary or many a times used inappropriately and often found to be the cause of injury or even death. The guidelines are restraints are medical appliances used as a last resort, when  
25 alternatives have been failed to prevent harm from violent or non violent behavior; It is also mandatory to provide a safe environment for the patient, who is in restraint; Patients and families must be provided with information on restraint to allow for an informed decision; Patient should be monitored every 15 minutes, Patient

restraint management flow chart sheet should be maintained every two hours, Physician is responsible for writing and reviewing the restraint order, Nurse is responsible for assessment and documentation, New order is required after 24 hours, Modify the environment, provide companionship and supervision; Give  
5 attention to patient's hydration, nutrition, elimination and range of motion; Keep record of patient's vital signs; Regular checks should be carried out that the restraint appliance does not restrict the circulation; Restraints are not to be used for discipline or staff convenience; Restraints should be applied by the trained staff.

The prior art US5546962 disclose a device for restraining movement without  
10 completely prohibiting movement is disclosed. Two coupling devices connected by a extensible material form the physical restraint device. One of the coupling devices may be coupled to a patient while the other may be coupled to a fixed object. The length and extensibility of the extensible material connecting the coupling devices determines the amount of movement allowed between the user and the fixed object.  
15 A variety of lengths and strengths of the extensible material may be used and interchanged. Because of the flexibility and extensibility of the material, the physical restraint device may also be used as an exerciser for the person being restrained. A recessed pin locking device is located within each coupling device. Access to each pin locking device is through a hole located in the coupling device. An object such  
20 as a pen or a pin must be inserted into the hole in order to release the locking device. When the locking device is released, the coupling device is opened so that it can be connected to or disconnected from the user or fixed object. Because the lock is recessed, access is quick and easy for the person applying the restraint, but is unavailable to the person being restrained. This device might work like handcuff and  
25 is difficult to prevent the movement of violent patients (like alcoholic, psychotic or the patients who consume poison) as the device of US'692' is restricted to specific movement only. Further, as the metal is used as a component US'962', this device would not suitable for performing certain important medical procedure such as MRI or CT scan.

Another disclosure US4414969 relates to wrist restraint which is a device especially for restraining the movements of the limb of a patient during a medical procedure is disclosed. The device includes a generally long rectangular flexible member which encircles the limb. The outside surface of this member is a Velcro loop pile. A strap having a Velcro hook fiber surface is attached at one of its ends to the encircling member. The strap is wrapped around the encircling member in the direction toward the end closest to which the strap is attached such that the Velcro hook fiber surface of the strap is brought into contact and locking engagement with the Velcro pile surface of the encircling member. The strap is routed through a small ring attached to the outside surface of the encircling member and proceeds to a support structure to which it is releasably attached by fastening means located at or near said end. Because of the locking engagement of the Velcro surfaces of the encircling member and the strap and the small size of the ring, the encircling member cannot be substantially tightened by a pulling force exerted on or by the encircled limb in a direction away from the support structure. As the patient's movement as concerned, US'969' is limited to particular part only, moreover the prior art is silent how the device is applicable to the violent patients.

Accordingly, there is a need to provide a solution for physically restraining the movement of a patient.

## 20 **OBJECT OF THE INVENTION**

It is an objective of the invention is to provide a medical device for physically restraining the movement of a patient.

It is another objective of the invention is to provide a device for physically restraining the movement of a patient who is non-cooperative.

25 It is another objective of the invention is to provide a novel polymer based physical restraint device.

It is yet another objective of the invention is to provide a device to ensure the immediate physical safety of the patients, staff members and others in emergency situation.

5 It is yet another objective of the invention is to provide a device to conduct certain procedures smoothly for instance inserting/securing important tubes, intravenous line etc.

It is yet another objective of the invention is to provide a device to prevent disoriented/alcoholic patient from self-extubation, oxygen cannulae, Ryle's tube, drains, naso-tracheal tube, urinary catheter etc.

10 It is yet another objective of the invention is to provide a physical restraint device with minimum discomfort.

It is yet another objective of the invention is to provide a device which does not cause ulcers or trauma to the wrist, ankles and skin.

15 It is further objective of the invention is to provide a device which can be used to prevent the movement of the patients who have undergo MRI or CT scan.

## **SUMMARY OF THE INVENTION**

There is provided A device for physically restraining movement of a patient comprising

20 first strap and second strap; the second trap being placed within the first strap;

plurality of buckles having a slide release mechanism; the said buckle being made up of polypropylene derivative;

a padding unit being made of the sheet which consists of polyethylene vinyl acetate;

wherein the first strap being made up a polymer selected from a combination of polyamide: polystyrene: polyacrylamide;  
wherein polyamide: polystyrene: polyacrylamide is 1.0:0.7:0.5 by weight.

In accordance with these and other objects which will become apparent hereinafter,  
5 the instant invention will now be described with particular reference to the accompanying drawing.

### **BRIEF DESCRIPTION OF THE ACCOMPANYING DRAWINGS**

10 Figure 1 illustrates schematically a physical restraint device in accordance with present invention;

Figure 2 illustrates schematically an outer view of the device in accordance with the present invention;

15 Figure 3 illustrates schematically a top view (closed manner) of the device in accordance with present invention;

Figure 4 illustrates a flow chart of working of the device in accordance with the present invention;

Figure 5 is an image of working of the device in accordance with the present invention.

20 Other objects, features and advantages of the inventions will be apparent from the following detailed description in conjunction with the accompanying drawings of the inventions.

### **DETAILED DESCRIPTION OF THE INVENTION**

25 Referring now to Figure 1 (inside view) and Figure 2 (outside view), the present invention provides a novel polymer based physical restraint device, the said device consists of:

- i) first strap (1);
- ii) second strap (2);
- iii) plastic buckles (3,4); &
- iv) padding unit (5)

5 i) First strap (denoting as symbol "1" in Figure 1):

The first strap (1) which could be considered as a base, used to fix with the cot/bed framework. The strap according to present invention is made up of a polymer which is selected from a group consisting of polyamide (nylon), polystyrene, polyacryl amide and the combination thereof. The ratio of the polymers polyamide, polystyrene and polyacrylamide as used in present invention is 0.5:0.5:0.5 to 1:1:1 by weight. All the polymers are commonly available in market. The suitable method known in the art is referred for making the strap.

15 The length of the first strap according to present invention is 38inch, while the width is 1.5inch. The thickness of the strap is 0.07inch.

ii) second strap (denoting as symbol "2" in Figure 1);

20 A second strap (2) is placed in between the first strap which is used as a support for first strap. The second strap according to present invention is made up of rexin and the suitable process known in art is used to prepare the second strap.

The length of the second strap according to present invention is 38inch and while the width is 0.05-1.5inch.

iii) plastic buckles (denoting as symbol "3,4" in Figure 1);

25 According to present invention, there are 3 buckles (3,4) having male (3)-female (4) system for ease of locking and un-locking. The buckles also have a

sliding release mechanism. The buckle according to present invention is made up of high density polypropylene which is also commonly available in market. The size of the buckle according to present invention is 1.5inch.

iv) padding unit (denoting as symbol “5” in Figure 1):

5           The padding unit (5) is used as cushioning purpose for the device, is made up of polyethylene-vinyl-acetate sheet, which is secured at patient’s wrist or ankles or both. The length of the padding unit according to present invention is 7inch, while the width is 2inch. The thickness of the padding unit is 2mm. Polyethylene-vinyl-acetate as used in the invention is commonly available in  
10           market.

As shown in Figure 3, present inventor illustrates the top view (close) of the physical restraint device.

The working of the device to establish the advantageous effect of the present invention is demonstrated in Figure 4 and 5. The studies were performed at  
15           **Krishna Institute of Medical Sciences and Krishna Hospital, Karad** and 10 patients is selected from each group as follows:

Cooperative:	10 NOS	} NON-COOPERATIVE
Alcoholic:	10 NOS	
Psychotic:	10 NOS	
Poison consuming:	10 NOS	

20

As shown in the flow chart (Figure 4), a patient who is sleeping on the bed and the device whose one end is secured to wrist and ankle of the patient (Figure 5) and another end is fixed to a bed framework. A system is attached to the bed framework so that it can be worked as an alarm when the patient gets  
25           detached from the device.

First strap of the physical restraint device is having the following ratio:

- 1) Polyamide: Polystyrene: Polyacrylamide = 0.5:0.5:0.5 by weight
  - 2) Polyamide: Polystyrene: Polyacrylamide = 0.5:0.7:1.0 by weight
  - 3) Polyamide: Polystyrene: Polyacrylamide = 1.0:0.7:0.5 by weight
- 5 The efficacy of the device is evaluated by the alarm system as above i.e. the alarm is ON if the patient gets unlocked any time after securing the device.

**Table 1: Efficacy of physical restraint device (in hours)**

Sr. No.	Patients			
	Co-operative	Alcoholic	Psychotic	Poison consuming
Polyamide: Polystyrene: Polyacrylamide = 0.5:0.5:0.5	Alarm on after 5 hour	Alarm on after 1 hour	Alarm on after 0.5 hour	Alarm on after 1 hour
Polyamide: Polystyrene: Polyacrylamide = 0.5:0.7:1.0	Alarm on after 5.5 hour	Alarm on after 1.2 hour	Alarm on after 0.5 hour	Alarm on after 1.1 hour
Polyamide: Polystyrene: Polyacrylamide = 1.0:0.7:0.5	Alarm on after 10 hour	Alarm on after 6 hour	Alarm on after 5 hour	Alarm on after 6.5 hour



Table 1 shows the superior effect of the first strap which is made up of Polyamide: Polystyrene: Polyacrylamide = 1.0:0.7:0.5. Accordingly the present device is not a mere admixture.

5 Although the foregoing description of the present invention has been shown and described with reference to particular embodiments and applications thereof, it has been presented for purposes of illustration and description and is not intended to be exhaustive or to limit the invention to the particular embodiments and applications disclosed. It will be apparent to those having ordinary skill in the art that a number of changes, modifications, variations, or alterations to the invention as described  
10 herein may be made, none of which depart from the spirit or scope of the present invention. The particular embodiments and applications were chosen and described to provide the best illustration of the principles of the invention and its practical application to thereby enable one of ordinary skill in the art to utilize the invention in various embodiments and with various modifications as are suited to the particular  
15 use contemplated. All such changes, modifications, variations, and alterations should therefore be seen as being within the scope of the present invention as determined by the appended claims when interpreted in accordance with the breadth to which they are fairly, legally, and equitably entitled.

20

25

30

**We Claim,**

1. A device for physically restraining movement comprising  
first strap (1) and second strap (2); the second trap being placed within the  
5 first strap;  
plurality of buckles (3,4) having a slide release mechanism; the said buckle  
being made up of polypropylene derivative;  
a padding unit (5) being made of the sheet which consists of polyethylene  
vinyl acetate;  
10 wherein the first strap being made up a polymer selected from a combination  
of polyamide, polystyrene and polyacrylamide;  
wherein polyamide: polystyrene: polyacrylamide is 1.0:0.7:0.5 by weight.
- 15 2. The device as claimed in claim 1, wherein length of the first strap is 38inch.
3. The device as claimed in claim 1, wherein width of the first strap is 1.5inch.
4. The device as claimed in claim 1, wherein thickness of the first strap is  
0.07inch.  
20
5. The device as claimed in claim 1, wherein length of the second strap is  
38inch.
6. The device as claimed in claim 1, wherein width of the second strap is  
25 1.5inch.
7. The device as claimed in claim 1, wherein length of the padding unit is 7inch.
8. The device as claimed in claim 1, wherein width of the padding unit is 2inch.

9. The device as claimed in claim 1, wherein thickness of the padding unit is 2mm.

10. The device as claimed in claim 1, wherein the buckle is 15 inch-buckles.

5

Dated this 25<sup>th</sup> day of August, 2018

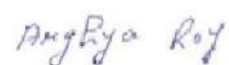

10

(Arghya Ashis Roy)  
Patent Agent (IN/PA 2346) of  
Lex-Regia  
**For the Applicant**

15

To,  
The Controller of Patents,  
The Patent Office  
At Mumbai

20

25

## ABSTRACT

### “A DEVICE FOR PHYSICALLY RESTRAINING MOVEMENT”

Disclosed is a device for physically restraining movement comprising first  
strap (1) and second strap (2); the second trap being placed within the first  
5 strap; plurality of buckles (3,4) having a slide release mechanism; the said  
buckle being made up of polypropylene derivative; a padding unit (5) being  
made of the sheet which consists of polyethylene vinyl acetate; wherein the  
first strap being made up a polymer selected from a combination of  
polyamide: polystyrene: polyacrylamide; wherein polyamide: polystyrene:  
10 polyacrylamide is 1.0:0.7:0.5 by weight. Figure 1

15

**FORM-2**

THE PATENTS ACT, 1970

(39 OF 1970)

&

THE PATENT RULES, 2003

**COMPLETE SPECIFICATION**

(SECTION 10, RULE 13)

**TITLE**

“AN INJECTION GUIDE”

**APPLICANT**

RAJASHRI BHAGWAT KARALE,

an Indian National,

Krishna Institute of Nursing Sciences and Krishna Hospital,

near Dhebewadi Road, Malkapur, Karad, Pin code- 415110,

Maharashtra, India

The following specification particularly describes the nature of the invention and the manner in which it is to be performed

## **FIELD OF THE INVENTION**

The present invention relates to an injection guide. More particularly, the present invention relates to an injection guide that provides the delivery process of intravenous, intramuscular, intradermal, subcutaneous etc more accurately and safely.

## **BACKGROUND OF THE INVENTION**

Injections are administered in various angles. Intramuscular injection is administered at 90°, subcutaneous injection at 45°, intravenous injection administered at 20° and intradermal injection at 10 to 15°.

10

Currently, what are the practices to determine these angles:

- i) At present injections angles are decided manually;
- ii) Devices are available for insertion of Jelcos/scalp veins for administration of Intravenous (IV) fluids/transfusions. Other devices are available to hold syringe i.e. Infusion pumps for intravenous infusion of micro-dose or IV fluids;
- iii) charts/Figures of various angles of administration of injections are available.

15

Many times errors in administration of injections were noted by health care professionals and as a result patient suffers from the complications which sometimes very severe and even in the case, the death might be happened due to this error.

20

## **PRIOR ART**

US3063449 discloses a syringe holder for supporting a syringe in a desired position such as an inclined position or location. According to US'449' the syringe can be moved from the remote location so a medical professional will be protected from a harmful drug. US'449' may be effective for intravenous process only. Also, the

25

mechanism of US'449' is electrically operated. Further, overall process of the administration is costlier.

US4332248 discloses an apparatus or guide to aid in inserting the needle of syringes and the like into body conduits such as veins. The apparatus includes a pair of members which are placed on the opposite sides of a vein, parallel to the longitudinal axis thereof, thereby preventing lateral movement of the vein while it is being pierced by the needle. A guide of US'248' is provided to aid in inserting the needle to the desired depth. US'248' is silent how the device is effective for other route of administration such as intramuscular, subcutaneous and intradermal process.

US2008/0269671 relates to a volume-adjustable micro-injection device. The device includes a base structure having a syringe positioning structure and a grip, in which the syringe positioning structure can flexibly accommodate injection syringes with different volumes; a holding structure capable of flexibly adjusting an injection angle of syringe content for easier operation; a qualitative controller capable of accurately controlling injection volume; a pressure pushing structure to hold and push a plunger; an injection controller interlinked with the qualitative controller and the pressure pushing structure; and an eject structure facilitating the operation and replacement of injection syringes. US'671' states in abstract that *"In contrast to conventional structures, the present invention provides advantages that control injection volume more accurately, address better injection angle control, allow for the syringe contents to be free from air exposure, require no special syringes, and allow for single-handed replacement of the injection syringe"*. However, how such better angle control is done is not disclosed in US'671'. Also, US'248' is silent on how the device is effective for other route of administration such as intramuscular, subcutaneous and intradermal process. Further, the mechanism of US'671' is electrically operated and overall process of the administration is costlier.

US2007/0232999 relates to an artery stabilizer device, with a slide over which a technician can guide a syringe, is provided for restraining a targeted artery while the

technician inserts the needle of the syringe into the artery. A pair of stabilizer fingers holds the artery in place while the syringe is maneuvered over the slide of a shaft which is connected to a base above the stabilizer fingers. US'999' discloses a finger-hold platform emanates from the bottom of the shaft, and a gauze dressing member with a gauze pad is removably attached to the bottom of the platform, allowing the technician to quickly apply a dressing over the wound created by the needle insertion procedure. An artery stabilizer adjustment track allows the technician to alter the width between each stabilizer finger. US'999' is silent on how the device is effective for other route of administration such as intramuscular, subcutaneous and intradermal process.

US2012/0000571 discloses a holding devices and methods for using the same. The holding device configured to hold a container having a dose or multiple doses of a liquid medicine with a needle-piercable cap. The holding device includes a holder for the container, a base, and an angular adjustment linkage between the base and the holder. Another aspect of the invention provides a method of loading a syringe with a liquid medicament held in a container. The method includes: providing a holding device including a holder for the container, a base, and an angular adjustment linkage between the base and the holder; placing the holding device on a surface; placing the container into the holder; and using two hands to draw the liquid medicament from the container into the syringe. The purpose of US'571' is to hold the vial only, not to administer into any route of injection.

WO2009047512 discloses an intravenous injection guide and a method of using such a guide which comprising a supporting base frame and one or more guider arms connected to the base frame whereby the guider arm or arms can be used so as to engage with a protrusion from a transfusion set in such a way that the contour of the guider arm or arms helps guide the trajectory of the transfusion needle into the vein of the patient during the act by a user of attempting veni-puncture access for medicinal infusion or blood sampling. It is basically a guiding apparatus for winged type infusion set where the needle of the latter can be assisted to follow a



fixed or adjustable or feel enhanced injection tranjectory path aided by guide thus enabling IV process made easier safe. The apparatus assists only for insertion of shaft of venous accesses needles/iv cannulas to superficial and deeper veins, not helps for vein identification/stabilization. The prior art doesn't point how to pierce the vein at 20° (which is the exact angle for intravenous injection) to give single dose of IV injection by simple manner i.e. injection needle attached with syringe. Also, WO'512' is winged type infusion set to which an additional syringe can be attached to give IV injection. The process is therefore is not cost-effective. Further, WO'512' is required transfusion set in conjunction with the specially G-transfusion set (wing type transfusion set) to locate the injection site. WO'512' is silent on how the device is effective for other route of administration such as intramuscular, subcutaneous and intradermal process.

Prior art findings limited to intravenous process only. Existing devices are not accurate and safe for other route of injection such as intramuscular, subcutaneous and intradermal with addition to intravenous process as there is no provision of determining the exact angle for the injection. Further, the existing devices are electrically operated and costlier in view of construction and overall mode of the treatment.

Accordingly, there is a need to provide an injection guide that could facilitate to determine the exact angle of an injection includes intravenous, intramuscular, subcutaneous and intradermal process.

## **OBJECT OF THE INVENTION**

It is an objective of the invention is to overcome the aforesaid drawbacks and accordingly provide an injection guide.

It is another objective of the invention is to provide an injection guide that provides the delivery process of intravenous, intramuscular, intradermal, subcutaneous more accurately and safely.

It is yet another objective of the invention is to provide an injection guide which facilitates intravenous process without use of jelcos/scalpel.

It is yet another objective of the invention is to provide a manually operated injection guide.

5 It is yet another objective of the invention is to provide injection process that can be carried out accurately with single needle.

It is yet another objective of the invention is to provide an injection guide which can be operated without any uncertainty and fear.

10 It is yet another objective of the invention is to provide an injection guide which can be operated by one who is under healthcare training.

It is yet another objective of the invention is to provide a cost effective injection process.

It is further objective of the invention is to provide an easy to handle injection guide.

## 15 **SUMMARY OF THE INVENTION**

There is provided an injection guide comprises

a holder (1) being cylindrical shape, said holder is having a provision for insertion of a syringe;

a base frame (6) means to support for the syringe holder;

20 primary angle unit (2) and secondary angle unit (4), said units having a predetermined degree of angle varying from 10° to 90°;

a primary pointer (3) and a secondary pointer (5);the primary pointer and the secondary pointer being connected to primary angle unit (2) and secondary angle unit (4) respectively;

5 a slit (7) being oval shape means to insert the needle; said slit being centrally placed in the said injection guide;

wherein the syringe holder (1) being fixed to the primary unit system (2,3) or the secondary unit system (4, 5) such that the needle of the syringe can  
10 attain an angle varying from 10° to 90°;

wherein length of the syringe holder is 46.92mm.

In accordance with these and other objects which will become apparent hereinafter, the instant invention will now be described with particular reference to the  
15 accompanying drawing.

### **BRIEF DESCRIPTION OF THE ACCOMPANYING DRAWINGS**

Figure 1a and 1b illustrates an injection guide in accordance with present invention;

20 Figure 2 illustrates a cylindrical shape of syringe holder in accordance with present invention;

Figure 3 illustrates the oval slit in accordance with present invention;

Figure 4 illustrates a side view (4a) and front view (4b) of the device in accordance with present invention; &

25 Other objects, features and advantages of the inventions will be apparent from the following detailed description in conjunction with the accompanying drawings of the inventions.

### **DETAILED DESCRIPTION OF THE INVENTION**

Present invention provides an injection guide for safe and accurate delivery process of the drug through the route selected from intravenous, intramuscular, intradermal and subcutaneous.

Referring now to Figure 1 (a & b), the injection guide according to present invention  
5 consists of:

a syringe holder (1);

a primary angle unit (2);

a primary pointer (3);

a secondary angle unit (4):

10 a secondary pointer (5);

a base (6);

a central slit (7);

a screw (8);

a nut (9);

15 a stopper (10);

Syringe holder:

The syringe holder (1) according to present invention is cylindrical shape (Figure 2) in which there is a provision of insertion of a syringe of 1cc (for 1mL), 2cc (for 2mL), 5cc (for 5mL) and 10cc (for 10mL) which is as per the need. The internal and  
20 external diameter of the syringe holder is as per the width of the syringe. The length of the syringe holder according to present invention is so as to adjust the syringe to get the desired angle for the injection. The critical length of the syringe holder according to present invention is 46.96mm.

Base:

The present invention includes a base (6) for stability while the injection is administered. The length of base according to present invention is as per the type of injection. In preferred embodiment, the length of the base is 26.83-54.5mm while  
5 the width is 16-28.8mm.

Primary and secondary angle unit:

According to present invention, left side on the base, there is primary angle unit (2) which presents a chart of 15°, 45° and 90°. One could select 45° for subcutaneous  
10 injection and 90° for intramuscular injection. The primary pointer (3) on the primary angle chart shows the current degree on chart.

On the other hand, at right side on the base, there is secondary angle unit (4) which presents a chart of 10° divisions up to 90°. One could select 10°-15° for intradermal  
15 injection and 20° for intravenous injection. The secondary pointer (5) on the secondary angle chart shows the current degree on chart. Primary angle unit along with primary pointer and secondary angle unit along with secondary here is primary unit system and secondary unit system respectively.

20 Other components:

The present invention also comprises an oval slit (7) which is centrally located in the design [Figure 3] means to insert the needle into the skin layer. The width of the slit is 4mm while the length is 45mm. The present device includes a screw with nut to  
25 attach syringe holder to the angle charts such as herein described. The present invention also includes a stopper to limit the injection holder to move above 90°. The syringe holder, the base and the other major components as used in the said injection guider is made of plastic known in art.

As shown in Figure 4a and 4b, the present inventor illustrates a side view and front  
30 view respectively of the device

Now, the invention is illustrated by non-limiting examples:

**Example 1:**

Injection guide for subcutaneous injection:

Insulin injection (1cc syringe along with needle, 1mL dose) through subcutaneous route (45° as standard angle) was performed on diabetic patient at **Krishna Institute of Nursing Sciences and Krishna Hospital, Karad** wherein

i) Syringe holder:

Length of the syringe holder: 25mm, 35mm, 46.92mm and 55mm

External diameter of the syringe holder: 10mm

10 Internal diameter of the syringe holder: 7mm

ii) Base:

Length of the base: 26.83mm

Width of the base: 16mm

15 iii) Primary and secondary unit angle along with pointer and other component as above

For intravenous (20° angle), intramuscular (90° angle) and intradermal (10° angle) injection, except length of the syringe holder, the dimension of other components was varied and it was selected as per the type of the injection.

**Table 1: Observation (Relation between length of the syringe holder and angle of the injection)**

20

Length of syringe holder of the injection	Injection route (angle)			
	10°	20°	45°	90°

guide	(intradermal)	(intravenous)	(subcutaneous)	(intramuscular)
25mm (comparative example)	unstable syringe	unstable syringe	unstable syringe	unstable syringe
35mm (comparative example)	unstable syringe	unstable syringe	unstable syringe	unstable syringe
46.92mm <b>(inventive example)</b>	stable syringe	stable syringe	stable syringe	stable syringe
55mm (comparative example)	Syringe is not moved	Syringe is not moved	Syringe is not moved	Syringe is not moved

Accordingly, the present inventor concludes that not only primary and secondary angle unit of the device but also length of the syringe holder is critical in order to achieve the desired angle for the injection.

- 5 Although the foregoing description of the present invention has been shown and described with reference to particular embodiments and applications thereof, it has been presented for purposes of illustration and description and is not intended to be exhaustive or to limit the invention to the particular embodiments and applications disclosed. It will be apparent to those having ordinary skill in the art that a number of
- 10 changes, modifications, variations, or alterations to the invention as described herein may be made, none of which depart from the spirit or scope of the present invention. The particular embodiments and applications were chosen and described

to provide the best illustration of the principles of the invention and its practical application to thereby enable one of ordinary skill in the art to utilize the invention in various embodiments and with various modifications as are suited to the particular use contemplated. All such changes, modifications, variations, and alterations  
5 should therefore be seen as being within the scope of the present invention as determined by the appended claims when interpreted in accordance with the breadth to which they are fairly, legally, and equitably entitled.

10

15

20

25

30

35

40



**I Claim,**

1. An injection guide comprises

5 a holder (1) being cylindrical shape, said holder is having a provision for insertion of a syringe;

a base frame (6) means to support for the syringe holder;

primary angle unit (2) and secondary angle unit (4), said units having a predetermined degree of angle varying from 10° to 90°;

10 a primary pointer (3) and a secondary pointer (5);the primary pointer and the secondary pointer being connected to primary angle unit (2) and secondary angle unit (4) respectively;

15 a slit (7) being oval shape means to insert the needle; said slit being centrally placed in the said injection guide;

wherein the syringe holder (1) being fixed to the primary unit system (2,3) or the secondary unit system (4, 5) such that the needle of the syringe can attain an angle varying from 10° to 90°;

20

wherein length of the syringe holder is 46.92mm.

2. The guide as claimed in claim 1, wherein the syringe is 1cc syringe, 2cc syringe, 5cc syringe or 10cc syringe.

25

3. The guide as claimed in claim 1, wherein length of the base is 26.83-54.5mm.

4. The guide as claimed in claim 1, wherein width of the base is 16-28.8mm.

5. The guide as claimed in claim 1 is made up of a plastic known to person-skilled-in-art.

5 6. The device as claimed in claim 1 is for an injection selected from a group consisting of intravenous, intramuscular, subcutaneous or intradermal.

Dated this 24<sup>th</sup> day of August, 2018

*Arghya Roy*

10

(Arghya Ashis Roy)  
Patent Agent (IN/PA 2346) of  
Lex-Regia  
**For the Applicant**

15

To,  
The Controller of Patents,  
The Patent Office  
At Mumbai

20

25

## ABSTRACT

### “AN INJECTION GUIDE”

Disclosed is an injection guide comprises a holder (1) being cylindrical shape, said holder is having a provision for insertion of a syringe; a base  
5 frame (6) means to support for the syringe holder; primary angle unit (2) and secondary angle unit (4), said units having a predetermined degree of angle varying from 10° to 90°; a primary pointer (3) and a secondary pointer (5); the primary pointer and the secondary pointer being connected to primary angle unit (2) and secondary angle unit (4) respectively; a slit (7) being oval shape  
10 means to insert the needle; said slit being centrally placed in the said injection guide; wherein the syringe holder (1) being fixed to the primary unit system (2,3) or the secondary unit system (4, 5) such that the needle of the syringe can attain an angle varying from 10° to 90°; wherein the length of the syringe holder is 46.92mm. The said device is used for intravenous,  
15 intramuscular, subcutaneous or intradermal injection. Figure 1

20



महाराष्ट्र MAHARASHTRA

2019

WN 268010

मुद्रांक विक्री कारण-

Reason of sale stamps and Amount

मुद्रांक विक्रेत घेणाराचे नांव व पत्ता-

Stamp Purchasers Name

हस्ते असल्यास घेणारे नांव व पत्ता

Stamp Purchasers Name

मुद्रांक विक्री नोंदवही नंबर

Serial No and Date

मुद्रांक विक्रेत घेणाराची सही

Stamp Purchasers Sign.

मुद्रांक विक्रेता-जी. महेश रामचंद्र मोहिते

परवाना क्र. 2293003/१६ मु.वि.ठिकाण-दु.वि.काराड.क्र.१

सहसिल काराड, महाराष्ट्र

जोडपत्र १ व २ / Annexure-I & II

REGISTRAR

Krishna Institute of Medical Sciences  
"Deemed To Be University", Karad

कारण  
ज्ञानाच्या सद्यस्थितीत कुलकर्णी

१०९१ दिनांक २४/१२/२०२०

A/A

मुद्रांक विक्रेताची सही

SUB. TREASURY OFFICER KARAD  
09 SEP 2020  
B  
SUB. TREASURY OFFICER KARAD

एक कारणासाठी ज्यांनी मुद्रांक खरेदी केला त्यांनी त्याच कारणासाठी मुद्रांक खरेदी केल्यापासून ६ महिन्यांत वापरणे बंधनकारक आहे.

### Transfer of Technology Agreement

This Technology Transfer ("ToT") Agreement made and entered into on this 10<sup>th</sup> day of December, 2020.

BETWEEN

**Krishna Institute of Medical Sciences** "Deemed to be University", Karad-415539, (hereinafter referred to as 'KIMS'), through its Registrar, referred as "First Party"

AND

**College of Engineering Pune**, Shivajinagar, Pune-411005, an Autonomous Institute of Govt. of Maharashtra (hereinafter referred to as 'COEP'), through the Director, referred as "Second Party".

AND

**M/S. NBE Tech**, Pashan-Sutarwadi Road, Pune-411021, through their Proprietor referred as "Third Party".

Add. Director of Research  
KIMSDU, Karad

AND

WHEREAS the COEP is an institution of national importance providing education and research in various areas of Science, Engineering and Technology.

AND

WHEREAS the KIMS is an institution imparting education in various field of medical health sciences including allied sciences.

AND

WHEREAS NBE Tech Pvt. Limited company and in the business of design, manufacture, marketing and sales and suppliers of scientific products to the Indian and the customers abroad;

AND

WHEREAS the COEP has been doing research, development and consulting assignments in various frontline areas including, Embedded Systems, Electronic Design, Medical Equipment Design, 3-D Printing, Mechanical Designs, Civil and Structural Designs, Data Analytics, Machine Learning, Industrial Automation, etc..

AND

WHEREAS KIMS has been in research, and development in the field of medical and health sciences including microbiology and biotechnology with medical assistance and research expertise

AND

WHEREAS M/S. NBE-TECH has been working on Design, Development, Manufacturing and Sales of scientific products.

AND

WHEREAS all the three parties COEP, KIMS and NBE-TECH desire to spell out the terms and conditions in respect of this collaboration and to enter into a Technology Transfer (ToT) Agreement for that purpose.

**NOW IT IS AGREED BY AND BETWEEN THE PARTIES AS UNDER**

## 1. BACKGROUND

The hospital-acquired infections, also known as nosocomial infections can be acquired within a hospital environment. The contact surfaces mainly equipment and furniture of hospitals are the main culprits in transmission of nosocomial pathogens such as multidrug-resistant pathogens including methicillin-resistant *Staphylococcus aureus* (MRSA), extended-spectrum beta-lactamase-producing bacteria (ESBL) e.g., Enterobacteriaceae such as *Klebsiella*, *Escherichia coli*, vancomycin-resistant enterococci (VRE) e.g., *E. faecalis*, *E. faecium*, etc[Drees et al., 2014]. The spread of these pathogens usually occurs through hand tools of healthcare practitioners, high-touch sites inside patient rooms, hospital utensils contaminated by droplets from infected patients and interventional procedures. The most common sites of infections are the surgical wounds, bloodstream and urinary tract. Air-borne transmission from infected patients (influenza, H1N1 and SARS COV-2, etc) is also a source of infection of such utensils and equipment.

At present such pathogens are neutralized by conventional sterilization (e.g. autoclaving, dry heat sterilization etc.) and chemical sanitization methods (e.g., ethanol, phenolic compounds, chlorites etc.). However, these methods are time consuming practices and may not be feasible for electronic equipment like IR

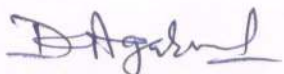

Add. Director of Research  
KIMSDU, Karad



thermometer, pulse oximeter, stethoscope, ECG electrodes and other hand tools used in OPDs, masks, stationary and dental equipment during surgery etc. Moreover, chemical treatment is not environmental friendly, may damage electronic equipment and develop resistance in pathogens. Several recent studies have demonstrated that an automated ultraviolet-C (UV-C) device may be effective as an adjunctive method for disinfection of healthcare associated pathogens [Nerandzic et al., 2012]. However, the use of germicidal UVC lamps for disinfection at the surgical site as well as sterilizing medical equipment in open environment is not preferred owing to UV radiation being both carcinogenic [Granstein et al., 2004] and cataractogenic [Wegener, 1995]. Therefore, there is a need to carefully develop the UVC light based sterilization chamber which is safe to humans while killing healthcare associated pathogens from surfaces of hospital utensils and portable medical equipment. Herein, we propose to design and develop a metallic double walled UV-C chamber for quick surface sterilization of hospital utensils and portable medical equipment for inactivation of SARS-CoV-2 and other nosocomial pathogens, so that utensils can be reuse again in few minutes. However, CDC and NSF International reported that the effectiveness of UV light for surface sterilization is dependent on factors like intensity, distance and exposure time [Dustin Grove, September 14, 2020]. For instance, Xenex's disinfecting robot, called LightStrike, can kill 99.99% of the severe acute respiratory syndrome coronavirus 2 (SARS-CoV2) in 2 min at a distance of 1 m. According to the International Ultraviolet Association, it is generally accepted that a dose of  $40 \text{ mJ} \cdot \text{cm}^{-2}$  of 254 nm light will kill at least 99.99% of "any pathogenic microorganism [Mackenzie, D., 2020].

## 2. SCOPE/TERMS OF COLLABORATION

- 2.1 The ToT agreement entitled to provide all the technical details about product on as is where is basis in order to achieve smooth manufacturing practices (details given in technology report).
- 2.2 The charges for authentication and certifications of the product from competent authority shall be paid by "First party".
- 2.3 The third party shall not alter or dilute the quality of product as per the specifications made under the document of ToT which has been authenticated and approved by competent authorities.
- 2.4 The first and second party shall not enter into the manufacturing or marketing of the product directly or indirectly.
- 2.5 The third party has willfully agreed to pay Rs. 4, 00,000/- to first and second party against the initial payment towards the transfer of technology. Out of total amount M/S. NBE-Tech shall be payable for Rs. 2, 50,000/- to the first party and Rs. 1, 50,000/- to second party.
- 2.6 Third Party, M/S. NBE-Tech shall have to pay 5% of total annual turnover of the product (2.5% to each party, First Party and Second Party) as a royalty at the end of each financial year from the date of signing of this ToT agreement.
- 2.7 The first and second party shall grant the design details of ToT agreement to the third party after the signing of this ToT agreement.
- 2.8 Any kind of breach in the conditions which has been mentioned in this document shall amount to withdrawal of this agreement by First and Second party.

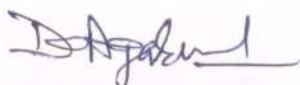

Add. Director of Research  
KIMSDU, Karad



### 3. INTELLECTUAL PROPERTY RIGHTS AND PUBLICATIONS (IF ANY)

- 3.1 Notwithstanding anything contained to the contrary, the entire rights, title and interest in any intellectual property including but not limited to patent and publications emerging out of the collaborative research to be carried out under this ToT ("IP") agreement, will be jointly owned by COEP, KIMS and NBE-TECH, if it is during the research and Development work.
- 3.2 The exclusive right of business and product development out of the patent, development will remain with COEP, KIMS and NBE-TECH and shall not license it to any other third party.
- 3.3 The fees towards filing and grant of Patents will be borne by COEP KIMS and NBE-TECH equally, if the original inventors are from both the parties. Royalty earned through such patents, if any, will be jointly shared by COEP, KIMS and NBE-TECH.

### 4. CONFIDENTIALITY

- 4.1 The term "Confidential Information" shall mean any information disclosed by one party ("Discloser") to the other ("Receiver"), pursuant to this ToT agreement or otherwise, which is in written, graphic, machine readable or other tangible form and is marked as 'Confidential' or 'Proprietary' or in some other manner to indicate its confidential nature. Confidential information may also include oral information disclosed by one party to the other, pursuant to this ToT agreement, provided that such information is designated as Confidential at the time of disclosure and reduce to a written summary by the disclosing party, within 30 days after its oral disclosure, which is marked in a manner to indicate its confidential nature and delivered to the receiving party.
- 4.2 For the term of this ToT agreement, each party, shall treat as confidential all confidential information of the other party, shall not use such confidential information except as expressly set forth herein or otherwise authorized in writing, shall implement reasonable procedures to prohibit the disclosure, unauthorized duplication, misuse or removal of the other parties confidential information and shall not disclose such confidential information to any third party except as may be necessary and required in connection with the rights and obligations of such party under this ToT agreement. Without limiting the foregoing, each of the parties shall use at least the same procedures and degree of care which it uses to prevent the disclosure of its own confidential information of like importance to prevent the disclosure of confidential information disclosed to it by the other party under this ToT agreement.

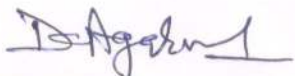
  
Add. Director of Research  
KIMSDU, Karad.



4.3 **Confidential information shall not include the information which,**

- i) was generally known and available at the time it was disclosed or becomes generally known and available through no fault of the receiver, was known to the recipient of such information, without restriction, at the time of disclosure as shown by the files of the recipient in existence at the time of disclosure,
  - ii) is disclosed with the prior written approval of the disclosure,
  - iii) was independently developed by the receiver without any use of the confidential information, and by employees and other agents of the receiver who have not been exposed to the confidential information, provided that the receiver can demonstrate such independent development by documented evidence prepared contemporaneously with such independent development.
  - iv) becomes known to the receiver, without restriction, from a source other than the discloser without breach of this ToT agreement by the receiver and otherwise, not in violation of the discloser's rights.
  - v) In addition, each party shall be entitled to disclose the other parties confidential information to the extent such disclosure is requested by the order or requirement of a Court, administrative agency, or other governmental body, provided that the party required to make the disclosure shall provide prompt and advance notice thereof, to enable the other party to seek a protective order or otherwise prevent such disclosure.
- 4.4 The parties shall, upon expiration of this ToT agreement, promptly deliver to each other, all material in its or its employees' possession or control containing such confidential information.
- 4.5 The provisions of this Clause shall survive the expiration or termination of this ToT agreement for a period of FIVE (5) years (Dec. 2020 to Dec. 2025).

5. **RELATIONSHIP OF THE PARTIES**

Nothing in this ToT agreement is intended to create a partnership, joint venture or other form of relationship between the Parties. Neither party makes any representations or warranties, whether express or implied. Neither party shall be liable to other for any indirect, consequential or any damages, whatsoever.

6. **EFFECTIVE DATE AND DURATION OF THE TOT AGREEMENT**

This ToT agreement shall be effective from the date it is signed by the parties hereto. The duration of the ToT agreement will be initially for a period of FIVE years from the Dec. 2020, unless or otherwise terminated earlier, as per

Page 5 of 7

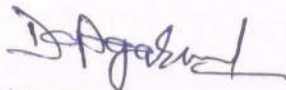
  
Add. Director of Research,  
KIMSDU, Karad

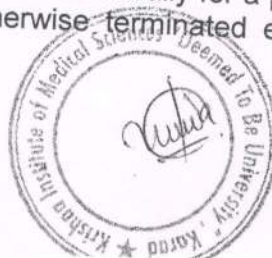



Clause 7. This duration can be extended further with mutual consent of all the parties. Early termination or expiry of this ToT agreement shall not affect any sponsorship already committed during the term of this ToT agreement.

#### 7. AMENDMENT TO TOT AGREEMENT

No amendment to this ToT agreement shall be valid unless the same is made in writing jointly by the parties hereto or their authorized representatives and specifically stating the same to be an amendment to this ToT agreement.

#### 8. TERMINATION OF TOT AGREEMENT

8.1 The ToT agreement shall not be terminated by COEP, KIMS and NBE-TECH during ongoing financial years.

8.2 This ToT agreement can be terminated by any party giving the other party, a prior written notice of not less than 60 days of its intention to do so but without dishonoring any commitment entered into prior to the date of termination notice.

8.3 Despite termination, the parties shall abide by the usual professional ethics and normal code of conduct to maintain the confidentiality of the information and any IPRs.

#### 9. SETTLEMENT OF DISPUTES

Any dispute arising in relation to or in connection with this ToT agreement between the parties shall be resolved by mutual negotiations. In case of any unresolved dispute, the parties shall refer the said dispute for arbitration, to the sole arbitrator appointed by all the Parties and the decision of the arbitrator shall be final and binding on all the three parties. The provisions of Arbitration and Conciliation Act, 1996 shall apply to such arbitration. Such arbitration proceeding shall be held at Pune Jurisdiction.





Add. Director of Research  
KIMSDU, Karad

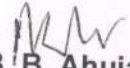

IN WITNESS WHEREOF both the parties hereto have set their hands, the date and year hereinabove mentioned.

For and behalf of:

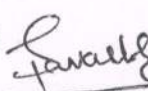
<b>College of Engineering Pune:</b>	Signature:  <b>Dr. B. B. Ahuja</b> Director
<b>Krishna Institute of Medical Sciences "Deemed To Be University", Karad:</b>	Signature:  <b>Dr. M. V. Ghorpade</b> Registrar
<b>NBE-TECH, Pune:</b>	Signature:  <b>Mr. Swapnil Awachar</b> Proprietor

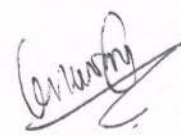
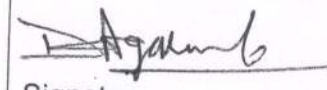
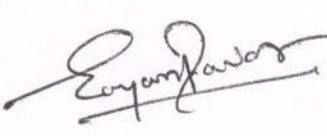
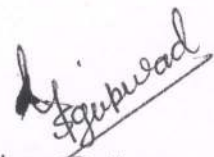

Witness:

Signature:  Date: 1. Dr. D. N. Sonawane Head of Department, Department of Instrumentation, College of Engineering, Pune, Pune-411005	Signature:  Date: 2. Dr. D. K. Agarwal Additional Director Research, Krishna Institute of Medical Sciences "Deemed to be University", Karad-415539
Signature:  Date: 3. Dr. Jayant Pawar, Research Associate, Directorate of Research, Krishna Institute of Medical Sciences "Deemed to be University", Karad-415539	Signature:  Date: 4. Mr. Shubham Gaikwad, NBE Tech, Pashan-Sutarwadi Road, Pune-411021

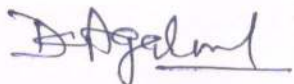

Add. Director of Research  
KIMSDU, Karad

# Technology Report

**Title of Technology:** Design and Development of UV-C Chamber for Quick Surface Sterilization of Hospital Utensils/portable equipment for Inactivation of SARS-CoV-2 and other Nosocomial Pathogens

**Running Title:** UV-SEVAK 360° for Quick Surface Sterilization of Hospital Utensils

## Researched and Developed by

1. Krishna Institute of Medical Sciences “Deemed to be University” (KIMSDU), Malkapur, Karad, Maharashtra 415539.
2. Department of Instrumentation, College of Engineering, Pune

<b>Document Type</b> Technology Report	<b>Thematic Area</b> Biomedical Instrumentation for Disease Prevention	<b>Research Division</b> Directorate of Research and Allied Sciences in association with Department of Instrumentation and Control, COEP
<b>Prepared by</b> Dr. Jayant Pawar KIMSDU Email: <a href="mailto:jayantpawar26@gmail.com">jayantpawar26@gmail.com</a> Mob: 8600867813	<b>Checked by</b> Dr. D. N. Sonawane Department of Instrumentation and Control, COEP Email: <a href="mailto:dns.instru@coep.ac.in">dns.instru@coep.ac.in</a> Mob: 9822888944	<b>Authenticated by</b> Dr. G. S. Karande HoD Department of Microbiology, KIMSDU, Karad Email: <a href="mailto:hodmicrobiology@kimskarad.in">hodmicrobiology@kimskarad.in</a>
<b>Research Team</b> <ol style="list-style-type: none"><li>1. Dr. Jayant Pawar, Directorate of Research, Krishna Institute of Medical Sciences “Deemed to be University”, Karad</li><li>2. Dr. D. N. Sonawane, Associate Professor and HoD, Department of Instrumentation and Control, COEP</li><li>3. Mrs. Neha Sawant, NBE Tech, Pune</li></ol>		

## Detail Project Report

### 1. Background of the Innovation

The hospital-acquired infections, also known as nosocomial infections can be acquired within a hospital environment. The contact surfaces mainly equipment and furniture of hospitals are the main culprits in transmission of nosocomial pathogens such as multidrug-resistant pathogens including methicillin-resistant *Staphylococcus aureus* (MRSA), extended-spectrum beta-lactamase-producing bacteria (ESBL) e.g., Enterobacteriaceae such as *Klebsiella*, *Escherichia coli*, vancomycin-resistant enterococci (VRE) e.g., *E. faecalis*, *E. faecium*, etc [Drees et al., 2014]. The spread of these pathogens usually occurs through hand tools of healthcare practitioners, high-touch sites inside patient rooms, hospital utensils contaminated by droplets from infected patients and interventional procedures. The most common sites of infections are the surgical wounds, bloodstream and urinary tract. Air-borne transmission from infected patients (influenza, H1N1 and SARS COV-2, etc) is also a source of infection of such utensils and equipment.

At present such pathogens are neutralized by conventional sterilization (e.g. autoclaving, dry heat sterilization etc.) and chemical sanitization methods (e.g., ethanol, phenolic compounds, chlorites etc.). However, these methods are time consuming practices and may not be feasible for electronic equipment like IR thermometer, pulse oximeter, stethoscope, ECG electrodes and other hand tools used in OPDs, masks, stationary and dental equipment during surgery etc. Moreover, chemical treatment is not environmental friendly, may damage electronic equipment and develop resistance in pathogens. Several recent studies have demonstrated that an automated ultraviolet-C (UV-C) device may be effective as an adjunctive method for disinfection of healthcare associated pathogens [Nerandzic et al., 2012]. However, the use of germicidal UVC lamps for disinfection at the surgical site as well as sterilizing medical equipment in open environment is not preferred owing to UV radiation being both carcinogenic [Granstein et al., 2004] and cataractogenic [Wegener, 1995]. Therefore, there is a need to carefully develop the UVC light based sterilization chamber which is safe to humans while killing healthcare associated pathogens from surfaces of hospital utensils and portable medical equipment. Herein, we propose to design and develop a metallic double walled UV-C chamber for quick surface sterilization of hospital utensils and portable medical equipment for inactivation of SARS-CoV-2 and other nosocomial pathogens, so that utensils can be reuse again in few minutes. However, CDC and NSF International reported

that the effectiveness of UV light for surface sterilization is dependent on factors like intensity, distance and exposure time [Dustin Grove, September 14, 2020]. For instance, Xenex's disinfecting robot, called LightStrike, can kill 99.99% of the severe acute respiratory syndrome coronavirus 2 (SARS-CoV2) in 2 min at a distance of 1 m. According to the International Ultraviolet Association, it is generally accepted that a dose of  $40 \text{ mJ}\cdot\text{cm}^{-2}$  of 254 nm light will kill at least 99.99% of "any pathogenic microorganism [Mackenzie, D., 2020].

## 2. Detailed Technology Description Proposed Work in the Light of SARS-CoV-2

UV sterilization technology is available for more than 40 years and mainly used for water treatment at household and industrial levels, however, limited attention was given for its use in sterilization in medical field. Nevertheless, its significance in hospital set-ups got highlighted in recent Covid-19 pandemic for effective inactivation of virus particles from hospital areas, utensils and portable medical equipment as quickly as possible. Specifically, UV-C radiation (Wavelength range 200-280 nm;  $\lambda_{\text{max}}$  254 nm) delivered using a dose of  $1 \text{ J}\cdot\text{cm}^{-2}$ , to each side of N95 face mask was found to be effective in decontamination of face pieces and straps [Hamzavi et al., 2020; Narla et al., 2020]. This dose is an appropriate decontamination method to facilitate reuse of respirators for healthcare personnel when applied to certain models/materials. However, this dose may vary from equipment to equipment and material to material. Moreover, International Ultraviolet Association advised to give a dose of  $40 \text{ mJ}\cdot\text{cm}^{-2}$  of 254 nm light to kill 99.99% of any pathogenic microorganism on surface of object.

## 3. Features of Prototype

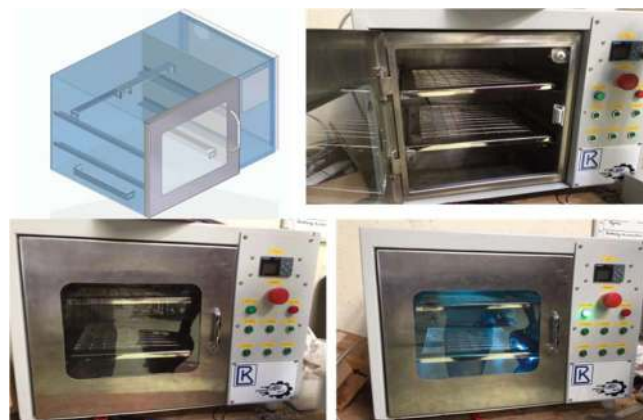

### a) Germicidal features

- Use of 254 nm germicidal radiation which is close to peak ultraviolet light absorption of nucleic acids i.e. 265 nm.
- Use of 4 UV-C lamps (11 W each) having specific UV-C wattage of 2.6 W each and placed in precise orientation to ensure total UV radiation of 254 nm wavelength of about 10.4 W from all sides on the object to be treated.
- The dose of  $>60 \text{ J}\cdot\text{cm}^{-2}$  of 254 nm light given, which is far enough for complete killing of pathogens when compared to recommended dose of light (According to the International Ultraviolet Association, it is generally accepted that a dose of  $40 \text{ mJ}\cdot\text{cm}^{-2}$  of 254 nm light will kill at least 99.99% of “any pathogenic microorganism).
- Effective calculated time to kills pathogen for present device is 0.8 min from the distance of 0.4 meter, however, we are giving minimum of 1 minute and maximum of 5 minute of exposure to the object for effective inactivation of germs (Xenex’s disinfecting robot, can kill 99.99% of the severe acute respiratory syndrome coronavirus 2 (SARS-CoV2) in 2 min at a distance of 1 m).
- Use of stainless steel container for effective reflection of radiation in the chamber avoiding ‘hiding effect’.
- Coating of racks by mixture of photocatalytic  $\text{TiO}_2$  NPs and Ag NPs for microbial inactivation of unexposed areas of objects placed on racks. (UV activated  $\text{TiO}_2$  has been shown to be capable of killing a wide range of Gram-negative and Gram-positive bacteria, filamentous and unicellular fungi, algae, protozoa, mammalian viruses and bacteriophage, moreover, the killing activity is enhanced by the presence of other antimicrobial agents such as Cu and Ag [Tatldil et al., 2011]).

#### **b) Safety features**

- Use of metallic double walled box to avoid leakage and direct exposure of harmful UVC radiation.
- Safety switch to automatically switch off UVC lamps if the chamber box is accidentally opened during operation.

#### **c) Other features**

- User friendly interface with quick buttons for time settings and display

- Use of standard UVC lamp (11 W) (lamp life of approx. 9000 hrs) and choke for steady intensity even after longer life usage, 230 V (AC) current supply and response time of 100 ms.
- Use of high quality SS-304 steel (corrosion resistant and highly reflective) and powder coated MS steel (aesthetic looking and rugged) for inner and outer boxes respectively.
- Simple design for easy servicing and maintenance whenever necessary.
- Spacious volume of more than 60 liters (such big volume is not available with any supplier) for treating bigger medical equipment and tools as well as personal belongings such as laptops, mobiles, display screens, etc.
- This sterilization box can also be used for household sterilization purposes (for items such as wallets, belts, mobiles, laptops, tablet phones, packaged grocery items, may fruits and vegetables, etc), at jewellery shops, take-away restaurants, toy shops, etc.

#### 4. Specification Sheet of UV-SEVAK 360°

Sr. No.	Parameters	Specifications
1	Lamp type	TI Mini UVC Germicidal Lamp
2	Lamp wavelength	254 nm
3	Number of lamps	Four
4	Efficiency testing	Antibacterial and antifungal efficacy of UV sterilizer tested and authenticated in Microbiology Laboratory at KIMSDU, Karad
5	Lamp usage	approx. 9000 hrs
6	Operating type	Continuous/timer
7	Sterilization time	< 1 minute for virus inactivation (as per published literature)*, 2 minutes for bacterial contaminants and 3 minutes for fungal contaminants (tested and approved by the KIMSDU, Karad)
8	Operating voltage	AC 230V/ 50Hz
9	Utility space	400 X 400 X 400 mm
10	Cooling system	Air cooling
11	Safety	Safety door switch

12	Power consumption	400 Watts
13	Material used	Powder coated MS
14	UV-C emission	10.5 Watts
15	Dose of UV-C	>60 J·cm <sup>-2</sup> (average expected dose for killing 99.99% microorganisms is 40 mJ·cm <sup>-2</sup> )

### 5. Key Features of Design:

1. Optimum power lamps for effective sterilization
2. Reflective inner surface for improving efficiency
3. Safety door switch for auto cut-off for user safety
4. Safety plates for lamp protection
5. Compact design with large utility space with nanomaterial coated racks
6. Flexible timer option
7. Four UV-C tubes place at specific angles for 360° illumination around the object

### 6. Verifications of results:

The effectiveness of developed device for its germicidal efficacy was tested at recognized Microbiology Laboratory at KIMSDU.

### 7. Guideline for Use of Device:

As UV-C light kills germs by direct exposure, it is mandatory to use system with awareness of the object to be sterilized. The exposure time can be set up from 30 seconds to 5 min for different types of objects. The less irradiance time (30 seconds to 2 min) is good for object with clean and smooth surface, whereas, the more irradiance time (3 min to 5 min) is recommended for object with rough surface as hiding places can limits its sterilization efficacy. We also recommend its use for minimum of 2 min to sterilize surfaces of hand tools and other small equipment in OPDs and mini OTs of medicine and dentistry.





महाराष्ट्र MAHARASHTRA

© 2019 ©

WL 501279

## Transfer of Technology Agreement

This Transfer of Technology Agreement (hereinafter referred to as "ToT") is made at Krishna Institute of Medical Sciences "Deemed to be University" (KIMSDU), Karad for the transfer of technology entitled "Nano-Herbal Coated Refillable Eco-friendly Anti-virulent Daily Protective Facemask" developed by KIMSDU, Karad. This Technology Transfer ("ToT") Agreement made and entered into on this 12<sup>th</sup> day of December, 2020.

BETWEEN

Krishna Institute of Medical Sciences "Deemed to be University", Karad ('KIMSDU'), through the Registrar, hereinafter referred to as "First Party"

AND

Krishna Sales and Services, A17/1, Milkat No 2367, Koyana Vasahat, Malkapur, behind Urban Bazar, Karad 415539, having GST No. 27AASFk1621P1ZS and PAN No. AASFk1621P through their marketing manager Mr. Chandrakant Eknath Mohite, hereinafter referred to as "Second Party".



Add. Director of Research  
KIMSDU, Karad



Page 1 of 6

WHEREAS the KIMSDU is an recognized Medical "Deemed to be university", accredited by NAAC with A grade, an ISO 9001:2015 certified University and is accredited by various reputed National and International bodies, having education and research expertise in the field of medical, paramedical, nursing, pharmaceutical and allied sciences.

WHEREAS the Krishna Sales and Services is involved in the manufacturing and marketing of biomedical products.

AND WHEREAS both the parties KIMSDU and Krishna Sales and Services desire to spell out the terms and conditions in respect of this collaboration and to enter into a Technology Transfer (ToT) Agreement for that purpose.

## NOW IT IS AGREED BY AND BETWEEN THE PARTIES AS UNDER

### 1. BACKGROUND

Currently, in COVID-19 pandemic it has become very clear that the use of face masks in public places can significantly prevent coronavirus (SARS COV-2) infection. The preliminary analysis was performed in 194 countries for estimating per-capita coronavirus mortality by considering public mask-wearing habit and it was found out that the average mortality increased drastically by 55 % per week in countries where, mask is not compulsory in public places as compared to merely 7.2% per week in countries where cultural norms and government policies supported wearing of masks in public places (Leffler et al., 2020). Similarly, another model from the University of Washington predicted that 80% adoption of face masks by public could reduce mortality by 24- 65% (Eikenberry et al., 2020). Despite of protection provided against SARS-CoV-2 virus by face masks, not all masks confer equal levels of protection. However, a conventional face mask can block smaller airborne particles like aerosols and large respiratory droplets produced when people cough, talk or exhale (Eikenberry et al., 2020).

Even WHO recommended wearing of masks by healthcare workers, ageing people, immunocompromised people and SARS-CoV-2 infected people as this practice was found to be a useful tool to prevent new infections in current COVID-19 pandemic (WHO, June 5th 2020). Moreover, general healthy public was advised to wear fabric masks by Centres for Disease Control and Prevention (CDC, July 16th 2020). However, the porosity of fabric is the constraining factor for its usability as effective mask. Over the last eight months, researchers have been evaluating the most effective mask materials for trapping the coronavirus. Additionally, medical masks are supposed to be discarded after each patient encounter or exposure to virus-laden aerosols and hence their disposability is a major concern highlighted in past few months in the upheaval of the COVID-19 pandemic. Therefore, it is mandatory to develop anti-virulent biodegradable mask from the material with increased reusability and ability to get sterilized by different ways. In the forbidding certainty of the COVID-19 pandemic, general public and working professionals around the world have been forced to either use unverified ways of cleaning and reusing their own masks or making their own in-house replacements due to uncertainty in the arrival of the next batch of new masks.



*D. Agarwal*

Add. Director of Research  
KIMSDU, Karad

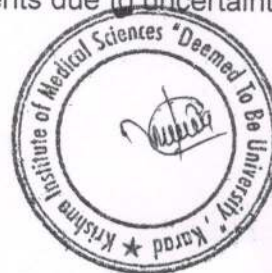

In this context, to grapple with shortages of masks and its disposal, the present study introduced certified woven fabric materials for making the masks with special design to incorporate replaceable anti-virulent cellulose layer coated with nano-herbal formulation for blocking and neutralizing aerosols containing virulent pathogens and other air-borne pathogens.

## 2. SCOPE/TERMS OF COLLABORATION

- 2.1 The ToT agreement entitled to provide all the technical details about product on as is where is basis in order to achieve smooth manufacturing practices (details given in technology report).
- 2.2 The charges for authentication and certifications of the product from competent authority shall be paid by "First party".
- 2.3 The second party shall not alter or dilute the quality of product as per the specifications made under the document of ToT which has been authenticated and approved by competent authorities.
- 2.4 The first party shall not enter into the manufacturing or marketing of the product directly or indirectly.
- 2.5 The second party has willfully agreed to pay Rs. 2, 00,000/- to first party against the initial payment towards the transfer of technology.
- 2.6 Second Party, shall have to pay 5 % of total annual turnover of the product as a royalty to the first party at the end of each financial year from the date of signing of this ToT agreement.
- 2.7 The first party shall grant the design details of ToT agreement to the second party after the signing of this ToT agreement.
- 2.8 Any kind of breach in the conditions which has been mentioned in this document shall amount to withdrawal of this agreement by First party.

## 3. INTELLECTUAL PROPERTY RIGHTS AND PUBLICATIONS (IF ANY)

- 3.1 Notwithstanding anything contained to the contrary, the entire rights, title and interest in any intellectual property including but not limited to patent and publications emerging out of the collaborative research to be carried out under this ToT ("IP") agreement, will be jointly owned by both the parties, if it is during the research and Development work.
- 3.2 The exclusive right of business and product development out of the patent, development will remain with both the parties.
- 3.3 The fees towards filing and grant of Patents will be borne by first party equally, if the original inventors are from first party. Royalty earned through such patents, if any, will be jointly shared by first and second party.

## 4. CONFIDENTIALITY

- 4.1 The term "Confidential Information" shall mean any information disclosed by one party ("Discloser") to the other ("Receiver"), pursuant to this ToT agreement or otherwise, which is in written, graphic, machine readable or other tangible form and is marked as 'Confidential'



Add. Director of Research  
KIMSDU, Karad



or 'Proprietary' or in some other manner to indicate its confidential nature. Confidential information may also include oral information disclosed by one party to the other, pursuant to this ToT agreement, provided that such information is designated as Confidential at the time of disclosure and reduce to a written summary by the disclosing party, within 30 days after its oral disclosure, which is marked in a manner to indicate its confidential nature and delivered to the receiving party.

4.2 For the term of this ToT agreement, each party, shall treat as confidential all confidential information of the other party, shall not use such confidential information except as expressly set forth herein or otherwise authorized in writing, shall implement reasonable procedures to prohibit the disclosure, unauthorized duplication, misuse or removal of the other parties confidential information and shall not disclose such confidential information to any third party except as may be necessary and required in connection with the rights and obligations of such party under this ToT agreement. Without limiting the foregoing, each of the parties shall use at least the same procedures and degree of care which it uses to prevent the disclosure of its own confidential information of like importance to prevent the disclosure of confidential information disclosed to it by the other party under this ToT agreement.

4.3 **Confidential information shall not include the information which,**

- i) was generally known and available at the time it was disclosed or becomes generally known and available through no fault of the receiver, was known to the recipient of such information, without restriction, at the time of disclosure as shown by the files of the recipient in existence at the time of disclosure,
- ii) is disclosed with the prior written approval of the disclosure,
- iii) was independently developed by the receiver without any use of the confidential information, and by employees and other agents of the receiver who have not been exposed to the confidential information, provided that the receiver can demonstrate such independent development by documented evidence prepared contemporaneously with such independent development.
- iv) becomes known to the receiver, without restriction, from a source other than the discloser without breach of this ToT agreement by the receiver and otherwise, not in violation of the discloser's rights.
- v) In addition, each party shall be entitled to disclose the other parties confidential information to the extent such disclosure is requested by the order or requirement of a Court, administrative agency, or other governmental body, provided that the party required to make the disclosure shall provide prompt and advance notice thereof, to enable the other party to seek a protective order or otherwise prevent such disclosure.

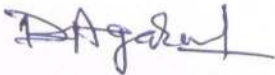

  
Add. Director of Research  
KIMSDU, Karad



- 4.4 The parties shall, upon expiration of this ToT agreement, promptly deliver to each other, all material in its or its employees' possession or control containing such confidential information.
- 4.5 The provisions of this Clause shall survive the expiration or termination of this ToT agreement for a period of FIVE (5) years (Dec. 2020 to Dec. 2025).

## 5. RELATIONSHIP OF THE PARTIES

Nothing in this ToT agreement is intended to create a partnership, joint venture or other form of relationship between the Parties. Neither party makes any representations or warranties, whether express or implied. Neither party shall be liable to other for any indirect, consequential or any damages, whatsoever.

## 6. EFFECTIVE DATE AND DURATION OF THE TOT AGREEMENT

This ToT agreement shall be effective from the date it is signed by the parties hereto. The duration of the ToT agreement will be initially for a period of FIVE years from the Dec. 2020, unless or otherwise terminated earlier, as per Clause 7. This duration can be extended further with mutual consent of all the parties. Early termination or expiry of this ToT agreement shall not affect any sponsorship already committed during the term of this ToT agreement.

## 7. AMENDMENT TO TOT AGREEMENT

No amendment to this ToT agreement shall be valid unless the same is made in writing jointly by the parties hereto or their authorized representatives and specifically stating the same to be an amendment to this ToT agreement.

## 8. TERMINATION OF TOT AGREEMENT

- 8.1 The ToT agreement shall not be terminated by first and second party during ongoing financial year.
- 8.2 This ToT agreement can be terminated by any party giving the other party, a prior written notice of not less than 60 days of its intention to do so but without dishonoring any commitment entered into prior to the date of termination notice.
- 8.3 Despite termination, the parties shall abide by the usual professional ethics and normal code of conduct to maintain the confidentiality of the information and any IPRs.

## 9. SETTLEMENT OF DISPUTES

Any dispute arising in relation to or in connection with this ToT agreement between the parties shall be resolved by mutual negotiations. In case of any

Page 5 of 6



*[Handwritten Signature]*

Add. Director of Research  
KIMSDB, Karad



unresolved dispute, the parties shall refer the said dispute for arbitration, to the sole arbitrator appointed by all the Parties and the decision of the arbitrator shall be final and binding on all the three parties. The provisions of Arbitration and Conciliation Act, 1996 shall apply to such arbitration. Such arbitration proceeding shall be held at Pune Jurisdiction.

IN WITNESS WHEREOF the parties hereby execute this Agreement on the day and year first above written.

For KIMSDU



Authorized Signatory  
Name: Dr. M. V. Ghorpade  
Designation: Registrar  
Date:



For Krishna Sales and Services



Authorized Signatory  
Name: Mr. Chandrakant Eknath Mohite  
Designation: Proprietor  
Date: 12/12/2020



Witness for KIMSDU



Authorized Signatory  
Name: Dr. D. K. Agarwal  
Designation: Additional Director of Research  
Date: 12/12/2020

Witness for Krishna Sales and Services

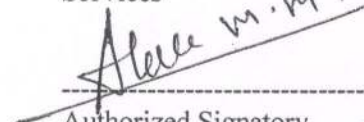

Authorized Signatory  
Name: Mr. Mahendee M. Alake  
Designation: Statistician  
Date: 12/12/2020

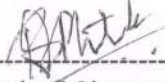

Authorized Signatory  
Name: Dr. Rohan S. Phatak  
Designation: Junior Research Officer  
Date: 12/12/2020

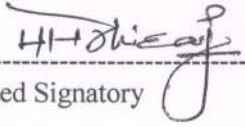

Authorized Signatory  
Name:  
Designation:  
Date: 12/12/2020

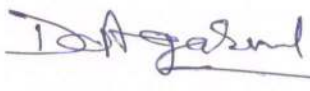

Add. Director of Research  
KIMSDU, Karad

# Technology Report

**Title of Technology:** Development of Anti-virulent Face Mask to Enhance the Disease Combat Efficiency of General Public and Professional Workers against COVID-19 and other Contagious Diseases

**Running Title:** Nano-Herbal Coated Refillable Eco-friendly Anti-virulent Daily Protective Facemask

## Researched and Developed by

Krishna Institute of Medical Sciences “Deemed to be University” (KIMSDU), Malkapur, Karad, Maharashtra 415539.

Document Type	Thematic Area	Research Division
Technical report and SOP	Biomedical Technology, Herbal Biotechnology, Nanotechnology and Textile Technology	Directorate of Research, KIMSDU, Karad
<b>Developed by</b> Dr. Jayant Pawar Research Associate, Directorate of Research, KIMSDU, Karad Email: <a href="mailto:jayantpawar26@gmail.com">jayantpawar26@gmail.com</a> Mob: 8600867813		<b>Authenticated by</b> 1.The South India Textile Research Association (SITRA), Coimbatore, Tamil Nadu 641014. 2.The Bombay Textile Research Association (BTRA), Mumbai, Maharashtra 400086.

## Preamble:

Currently, in COVID-19 pandemic it has become very clear that the use of face masks in public places can significantly prevent coronavirus (SARS COV-2) infection. The preliminary analysis was performed in 194 countries for estimating per-capita coronavirus mortality by considering public mask-wearing habit and it was found out that the average mortality increased drastically by 55 % per week in countries where, mask is not compulsory in public places as compared to merely 7.2% per week in countries where cultural norms and government policies supported wearing of masks in public places (Leffler et al., 2020). Similarly, another model from the University of Washington predicted that 80% adoption of face masks by public could reduce mortality by 24- 65% (Eikenberry et al., 2020). Despite of protection provided against SARC-

CoV-2 virus by face masks, not all masks confer equal levels of protection. However, a conventional face mask can block smaller airborne particles like aerosols and large respiratory droplets produced when people cough, talk or exhale (Eikenberry et al., 2020).

Even WHO recommended wearing of masks by healthcare workers, ageing people, immunocompromised people and SARS-CoV-2 infected people as this practice was found to be a useful tool to prevent new infections in current COVID-19 pandemic (WHO, June 5<sup>th</sup> 2020). Moreover, general healthy public was advised to wear fabric masks by Centres for Disease Control and Prevention (CDC, July 16<sup>th</sup> 2020). However, the porosity of fabric is the constraining factor for its usability as effective mask. Over the last eight months, researchers have been evaluating the most effective mask materials for trapping the coronavirus. Additionally, medical masks are supposed to be discarded after each patient encounter or exposure to virus-laden aerosols and hence their disposability is a major concern highlighted in past few months in the upheaval of the COVID-19 pandemic. Therefore, it is mandatory to develop anti-virulent biodegradable mask from the material with increased reusability and ability to get sterilized by different ways. In the forbidding certainty of the COVID-19 pandemic, general public and working professionals around the world have been forced to either use unverified ways of cleaning and reusing their own masks or making their own *in-house* replacements due to uncertainty in the arrival of the next batch of new masks.

In this context, to grapple with shortages of masks and its disposal, the present study introduced certified woven fabric materials for making the masks with special design to incorporate replaceable anti-virulent cellulose layer coated with nano-herbal formulation for blocking and neutralizing aerosols containing virulent pathogens and other air-borne pathogens.

## **Technical Details**

The product innovation is in the interdisciplinary field of biological science, nanotechnology and computational science. It relates to a development of anti-virulent face mask which can protect the user from all the possible pathogens (viruses, bacteria, fungi etc.) transmitting through air and air droplets. The most effective masks used by health workers are medical masks, FFP1, FFP2, FFP3, PAPR, SAR etc., which offer protection from droplets and airborne particles due to its tight-fitting and material made of spun-bonded polypropylene (Ippolito et al., 2020).

## **Conventional Masks and their Loopholes (Fig. 1)**

- **Currently, the masks we use include;**
  1. Medical Masks (one-time use medical mask, medical surgical mask, and medical protective mask)
  2. Particle Protective Masks (daily protective mask, PM2.5 protective mask, and protective masks (with plus P100 filter cotton))



- **Material used:** non-woven polypropylene fiber with/without exhalation valve to reduce breathing resistance.
- **Protection against:** Air borne pathogens, air pollutants, aerosols
- **Mechanism of protection:** Electrostatic, filtration, physical barrier
- **Usages:** one to three times (if taken off the mask after going home, put it in a ventilated environment, naturally dry and dry the moisture in it, prevent the accumulation of surface flora, then it can be used for maximum of 3 days), disposable, non-washable
- **Price range:** ~ Rs. 30 to 150 per unit for disposable and ~ Rs. 80 to 200 per unit for reusable, washable (max. 30 wash) masks.

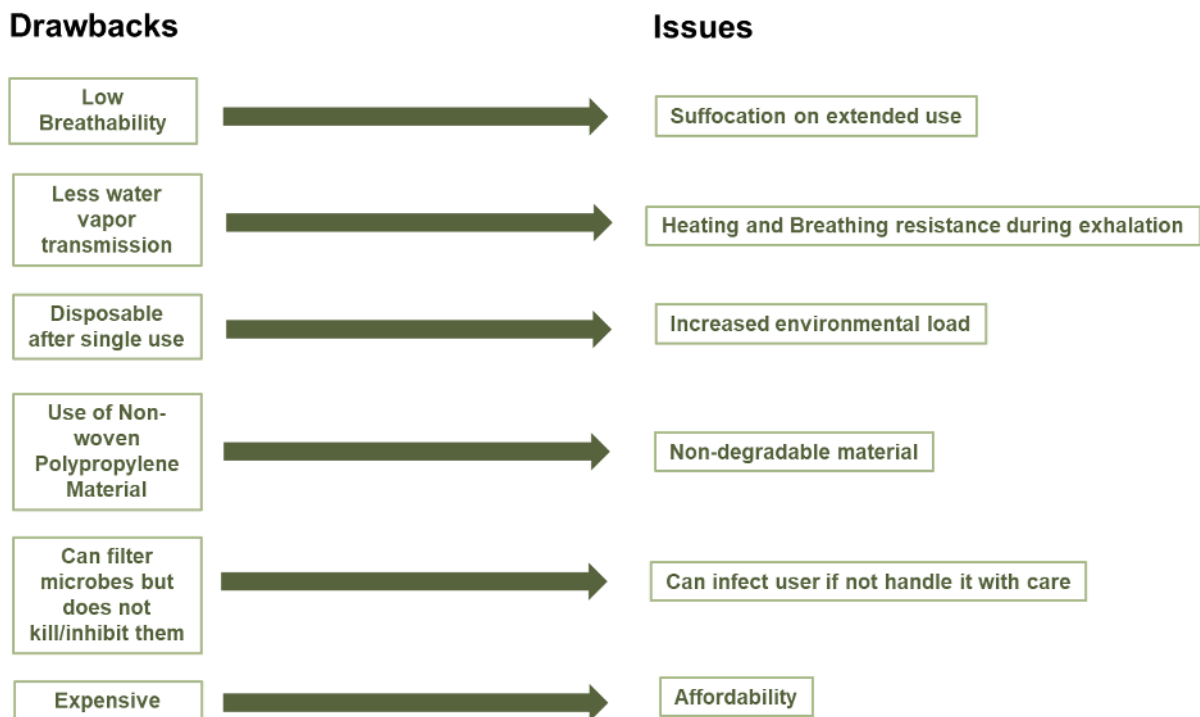

**Fig. 1.** Drawbacks and associated issues of conventional masks

Additionally, few innovative multi-layered masks (made of two layers of 600-thread-count cotton with another material like silk, chiffon, or flannel, filter >80% of particles have also been developed (Wilson et al., 2020). It was evidenced that the very finely woven fabric made from higher weave densities (i.e., thread count) in this regards, 600 TPI (threads per inch) thread count can significantly prevent the entry of dust particles and airborne pathogens into respiratory system (Konda et al., 2020). As per the information available, conventional face masks (as well as the innovative face mask reported by Wilson et. al. 2020) are unable to provide sufficient protection to people from all infectious diseases as such mask can only prevent the entry of some pathogens into human body but does not inhibit them. Hence, the above unfulfilled requirement (virus inhibition) of the current masks will be satisfied by our innovation, which includes research on the development of the inhibitory active layer in the mask comprising homogenous hybrid mixture of herbal constituents and inorganic nanomaterials. The developed face mask (Fig. 2) has designed with stipulations to fulfill the requirement of the general public and professional workers in current pandemic.

**i. The Components of the Mask: (Tested and certified at SITRA and BTRA)**

1. Layer 1 (innermost layer): Preventive in function, breathable, soft, washable and reusable.  
Choice of material: Black, 600 threaded woven cloth.
2. Replaceable anti-virulent paper: Preventive/Inhibitory in function, made up of filter paper (Whatman Grade 1 with particle retention of 11  $\mu\text{m}$  at 98 % efficiency), coated with nano-herbal anti-virulent formulation, replaceable after use.  
Choice of material: Organic formulation (herbal extracts &/or essential oils), Inorganic formulations (metal oxide nanoparticles).
3. Layer 2 (Middle layer): Preventive, electrostatic property, washable, reusable, breathable.  
Choice of material: Chiffon/ Silk-chiffon
4. Layer 3 (Outermost layer): Dust repellent properties, antistatic property, washable, reusable, and breathable.  
Choice of material: Super polyester

**ii. Schematic representation of proposed mask**

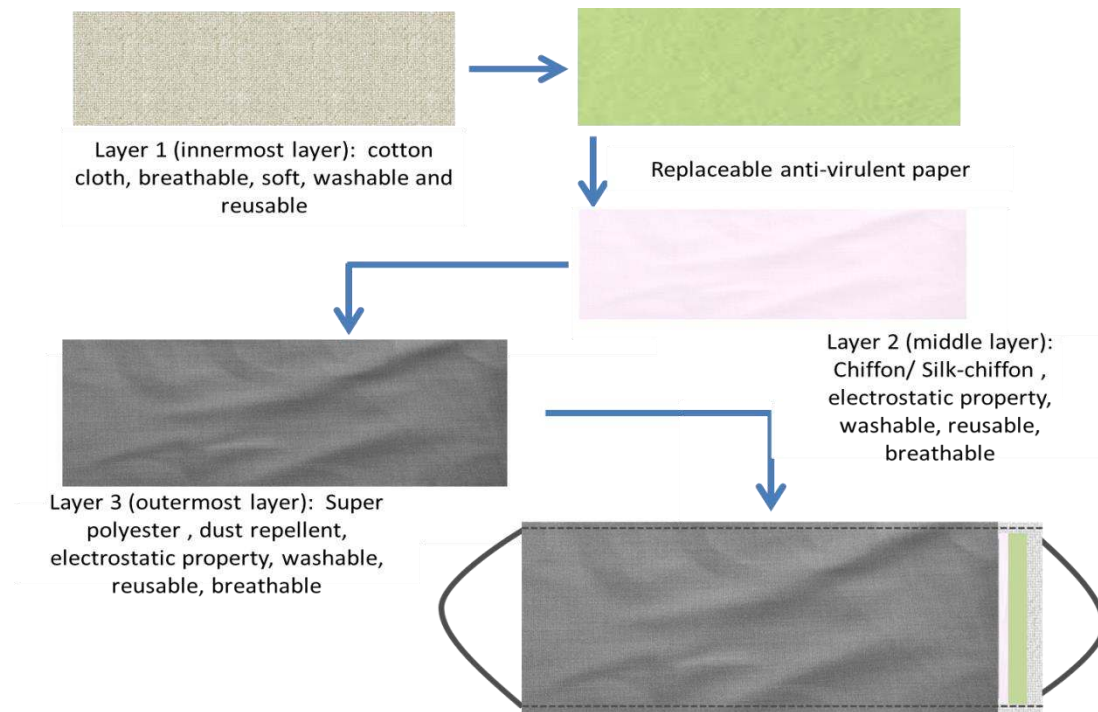

**Fig. 2.** Schematic of the K- BioMask

**Our R&D efforts will revolve around sandwich layer comprising active functional layer of nano- herbal formulation coating over disposable filter paper.**

**With this design, anti-virulent active layer sandwiched between specific fabric materials can be replaced after a 5 days of use, while the remainder of the mask can be used**

**repeatedly after washing and sterilization. Thus, refillable layer is the only expendable item of the mask which eventually is biodegradable thus reducing the environmental burden.**

### **iii. Materials and Methods**

#### **3.1. Material Selection for Anti-virulent paper**

For development of inhibitory anti-virulent paper, the reported organic anti-virulent (anti-viral, anti-bacterial and anti-fungal) extract and essential oils from plants such as *Cinnamomum zeylanicum*, *Eucalyptus globulus*, *Melaleuca alternifolia*, *Rosmarinus officinalis* and metal oxide nanomaterials like CuO and ZnO nanoparticles has been used to coat the cellulose filter paper. These reported anti-virulent materials/hybrids was used in various proportions and tested to obtain effective and optimized formulation for the developed product. There are many reported natural and synthetic remedies that are found to have anti-viral, anti-bacterial and anti-fungal properties, which further can be used for making of effective anti-virulent formulation to develop functionalized active anti-virulent substrate. The reported materials found to have anti-virulent properties include, black elderberry (*Sambucus nigra*) (Chen et al., 2014), Echinacea (*Echinacea purpurea*) (Pleschka et al., 2009), Garlic (Upadhyay, 2016), Green tea (*Camellia sinensis*) (Friedman, 2007), Liquorice (Gish and Keefe, 1995), Olive trees (*Olea europea*) (Salih et al., 2017), *Cinnamomum zeylanicum*, *Daucus carota*, *Eucalyptus globulus* and *Rosmarinus officinalis* (Brochet et al., 2017), essential oils of thyme, lemon, oregano and lavender (Man et al., 2019). While inorganic nanomaterials like colloidal silver (Petica et al., 2008), CuO nanoparticles (Tavakoli et al., 2020), ZnO nanoparticles (Ghaffari et al., 2019) and Au nanoparticles (Kim et al., 2020) etc. have also been reported to be anti-viral. However, this list of organic and inorganic nanomaterials is not comprehensive. There are many materials/compounds which have been sporadically reported and some of them are not reported at all.

**An attempt was made in this study to use computational tool for data mining, data classification, data enrichment and molecular docking to obtain an appropriate list of more suitable anti-virulent compounds from extracts and essential oils (Table 1, 2 and 3) and (figure 3). Additionally, it is highly recommended for more effective results that at least two or three of these materials/compounds should be used in conjunction in order to vanquish viruses and other microbes.**

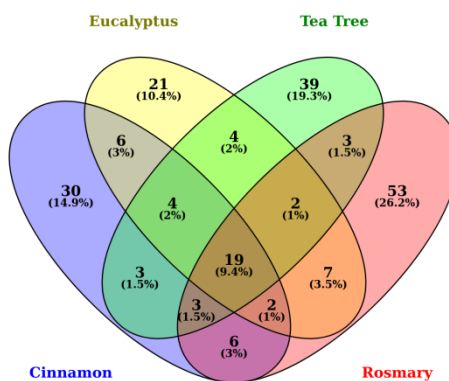

**Figure 3: Selected Active Compounds for Anti-virulent Formulation**

In this context, the formulation can be made out of available materials/compounds in India and can be used effectively for development of proposed functionalized active anti-virulent substrate for face mask. **Based on the data mining and computational (studying interaction of these compounds/materials with SARS COV-2 virus proteins) results, the compounds/materials has been selected (Table 4, 5 and 6).**

**Table 1: List of natural anti-viral compounds (herbal extract) obtained by data mining through computational tools (Detail data given in the Annexure I)**

1	2	3	4	5	6	7	8	9	10
Compound	Plant Source	Test system Type	Test system	Dose/concentration	Proposed mechanism	Broad Area of mechanism	IC50 or EC50 value	Reference	
3-(3-methylbut-2-enyl)-3',4,7-trihydroxyflavone	<i>Broussonetia papyrifera</i>	Target	3-chymotrypsin-like and papain-like	0-200 µM	Protease inhibition	Virus replication	-	Park et al., 2017	
Halimeda lunata	<i>Halimeda lunata</i>	Virus	Murine coronavirus A59	—	Undefined	Undefined	—	Koehn et al., 1991	
Hygromycin B	<i>Streptomyces hygroscopicus</i>	Virus	Mouse hepatitis virus (MHV-A59)	0-1 µM/kg	Reduced virus replication and necrotic	Virus replication	-	MacIntyre et al., 1991	
Myricetin	<i>Myrica rubra</i>	Virus	SARS-CoV	0.01-10 µM	3CL protease inhibition	Virus replication	-	Yu et al., 2012	
Quercetin	<i>Houttuynia cordata</i>	Virus	Murine CoV	500-15.63 µg/mL	Undefined	Undefined	-	Chiew et al., 2016	
Rutin	<i>Houttuynia cordata</i>	Virus	Murine CoV	500-15.63 µg/mL	Undefined	Undefined	-	Chiew et al., 2016	
7-Methoxycryptolourine	<i>Tylophora indica</i>	Virus	SARS-CoV	—	Protease inhibition	Virus replication	0.005 µM	Yang et al., 2010	
Hemoharringtonine	<i>Cephaelis fortunei</i>	Virus	Murine CoV (MHV-2aFLS)	0-70 nM	Undefined	Undefined	0.012 µM	Cao et al., 2015	
Lycorine	<i>Lycoris radiata</i>	Virus	SARS-CoV	10-1-10-4 mg/mL	Undefined	Undefined	0.0157 µM	Li et al., 2005	
Tylophorine	<i>Tylophora indica</i>	Virus	SARS-CoV	—	Protease inhibition	Virus replication	0.018 µM	Yang et al., 2010	
7-Methoxycryptolourine	<i>Tylophora indica</i>	Cell	CoV-infected swine testicular cells	—	Inhibition of viral replication	Virus replication	0.020 µM	Yang et al., 2010	
Silvestrol	<i>Aglaia stellatoploea</i>	Virus	HCoV-229E	0.6-2 µM	Inhibition of cap-dependent viral mRNA	Virus replication	0.040 µM	Muller et al., 2018	
(+)-Catechin gallate and (-)-Gallocatechin	<i>Camellia sinensis</i>	Virus	SARS-CoV	0.001-1 µg/mL	Inhibition of nanoparticle-based RNA	Virus replication	0.05 µg/mL	Rah, 2012	
Tylophorine	<i>Tylophora indica</i>	Cell	CoV-infected swine testicular cells	—	Inhibition of viral replication	Virus replication	0.058 µM	Yang et al., 2010	
Emetine	<i>Psychotria leocaulantha</i>	Virus	MHV-A59	0-5 µM	Inhibited RNA, DNA and protein synthesis	Virus replication	0.12 µM	Shen et al., 2019	
Quabain	<i>Somali waababayi</i>	Virus	Transmissible gastroenteritis CoV	0-3,000 nM	Diminished both the viral titers and viral	Virus replication	0.143 µM	Yang et al., 2018	
Lycorine	<i>Lycoris radiata</i>	Virus	HCoV-CoV	0-5 µM	Inhibited cell division	Virus replication	0.15 µM	Shen et al., 2019	
Emetine	<i>Psychotria leocaulantha</i>	Virus	HCoV-OC43	0-5 µM	Inhibited RNA, DNA and protein synthesis	Virus replication	0.30 µM	Shen et al., 2019	
Lycorine	<i>Lycoris radiata</i>	Virus	MHV-A59	0-5 µM	Inhibited cell division	Virus replication	0.31 µM	Shen et al., 2019	
Tetraodonin	<i>Stephania tetrandra</i>	Cell	HCoV-OC43-infected MRC-5 huma	2-20 µM	Undefined	Undefined	0.33 µM	Kim et al., 2019	
Emetine	<i>Psychotria leocaulantha</i>	Virus	MERS-CoV	0-5 µM	Inhibited RNA, DNA and protein synthesis	Virus replication	0.34 µM	Shen et al., 2019	
Lycorine	<i>Lycoris radiata</i>	Virus	HCoV-NL63	0-5 µM	Inhibited cell division	Virus replication	0.47 µM	Shen et al., 2019	
Tylophorine	<i>Tylophora indica</i>	Virus	CoV	0-1 µM	Targeting viral RNA replication and cell	Virus replication	0.5 µM	Yang et al., 2017	
Botulinic acid	<i>Botulin pubescens</i>	Virus	SARS-CoV	0-10 µM	Inhibition of replication	Virus replication	0.63 µM	Wen et al., 2007	
7-Phloroecdol	<i>Ecklonia cava</i>	Virus	Porcine epidemic diarrhea CoV	1-200 µM	Blockage of the binding of virus to cells	Virus entry	18.6 µM	Kwon et al., 2013	
Cepharanthine	<i>Stephania cepharantha</i>	Cell	HCoV-OC43-infected MRC-5 huma	2-20 µM	Undefined	Undefined	0.83 µM	Kim et al., 2019	
Scutellarein	<i>Scutellaria baicalensis</i>	Virus	SARS-CoV	0.01-10 µM	3CL protease inhibition	Virus replication	0.86 µM	Yu et al., 2012	
Fangchinoline	<i>Stephania Tetrandra</i>	Virus	HCoV-OC43-infected MRC-5 huma	2-20 µM	Undefined	Undefined	1.01 µM	Kim et al., 2019	
Havachlorophene	<i>Psychotria leocaulantha</i>	Virus	Murine CoV (MHV-2aFLS)	0-10 µM	Undefined	Undefined	1.2 µM	Cao et al., 2015	
Beta-sitosterol	<i>Isatis indigotica</i>	Virus	SARS-CoV	1-100 µg/mL	3CL protease inhibition	Virus replication	1.210 µM	Lin et al., 2005	
Femughol	<i>Seoulia sempervirens</i>	Virus	SARS-CoV	0-10 µM	Inhibition of replication	Virus replication	1.39 µM	Wen et al., 2007	
Emetine	<i>Psychotria leocaulantha</i>	Virus	HCoV-NL63	0-5 µM	Inhibited RNA, DNA and protein synthesis	Virus replication	1.43 µM	Shen et al., 2019	
8β-hydroxyabieta-9(11),13-dien-1,2-one	<i>Berberis amurensis</i>	Virus	SARS-CoV	0-10 µM	Inhibition of replication	Virus replication	1.47 µM	Wen et al., 2007	
Berberamine	<i>Berberis amurensis</i>	Virus	HCoV-NL63	0-20 µM	Undefined	Undefined	1.48 µM	Shen et al., 2019	
3β,12-diacetoxylabieta-6,8,11,13-tetraone	<i>Berberis amurensis</i>	Virus	SARS-CoV	0-10 µM	Inhibition of replication	Virus replication	1.57 µM	Wen et al., 2007	
Lycorine	<i>Lycoris radiata</i>	Virus	MERS-CoV	0-5 µM	Inhibited cell division	Virus replication	1.63 µM	Shen et al., 2019	
Chrysin	<i>Radix scutellariae</i>	Virus	SARS-CoV	0-400 µM	Inhibited interaction of SARS-CoV (S) p	Virus entry	200 µM	Ho et al., 2007	
Botulinic acid	<i>Botulin pubescens</i>	Virus	SARS-CoV	8-80 µM	3CL protease inhibition	Virus replication	10 µM	Wen et al., 2007	
4'-O-methylbavachalcone	<i>Psoralea corylifolia</i>	Virus	SARS-CoV	1-150 µM	PLpro protease inhibition	Virus replication	10.1 µM	Kim et al., 2014	
Diplazone	<i>Paulownia tomentosa</i>	Virus	SARS-CoV	0-100 µM	PLpro protease inhibition	Virus replication	10.4 µM	Cho et al., 2013	
Cinnamannin B1	<i>Cinnamomi cortex</i>	Virus	SARS-CoV	0-500 µM	Inhibition of pseudovirus infection	Virus entry	32.9 µM	Zhuang et al., 2009	
Botulinic acid	<i>Botulin pubescens</i>	Virus	SARS-CoV	8-80 µM	3CL protease inhibition	Virus replication	100 µM	Wen et al., 2007	
Hinokinin	<i>Chamaecyparis obtusa</i>	Virus	SARS-CoV	8-80 µM	3CL protease inhibition	Virus replication	100 µM	Wen et al., 2007	
Tomontin C	<i>Paulownia tomentosa</i>	Virus	SARS-CoV	0-100 µM	PLpro protease inhibition	Virus replication	11.5 µM	Cho et al., 2013	
Phlorofucofuroeckolins	<i>Ecklonia cava</i>	Virus	Porcine epidemic diarrhea CoV	1-200 µM	Inhibition of viral replication	Virus replication	12.2 µM	Kwon et al., 2013	
Tomontin D	<i>Paulownia tomentosa</i>	Virus	SARS-CoV	0-100 µM	PLpro protease inhibition	Virus replication	12.5 µM	Cho et al., 2013	
4'-O-methylcliclozane	<i>Paulownia tomentosa</i>	Virus	SARS-CoV	0-100 µM	PLpro protease inhibition	Virus replication	12.7 µM	Cho et al., 2013	
Quercetin	<i>Houttuynia cordata</i>	Virus	Murine CoV	500-15.63 µg/mL	Undefined	Undefined	125.00 µg/mL	Chiew et al., 2016	
3'-O-methylcliclozane	<i>Paulownia tomentosa</i>	Virus	SARS-CoV	0-100 µM	PLpro protease inhibition	Virus replication	13.2 µM	Cho et al., 2013	
Saikosaponins D	<i>Bupleurum Radix</i>	Virus	HCoV-229E	5-25 µM/mL	Undefined	Undefined	13.2 µM/mL	Cheng et al., 2006	
6-garany-4',5,7-trihydroxy-3',5'-di	<i>Paulownia tomentosa</i>	Virus	SARS-CoV	0-100 µM	PLpro protease inhibition	Virus replication	13.9 µM	Cho et al., 2013	
Mmuloane	<i>Paulownia tomentosa</i>	Virus	SARS-CoV	0-100 µM	PLpro protease inhibition	Virus replication	14.4 µM	Cho et al., 2013	
Dioidol	<i>Ecklonia cava</i>	Virus	Porcine epidemic diarrhea CoV	1-200 µM	Inhibition of viral replication	Virus replication	14.6 µM	Kwon et al., 2013	
Isobavachalcone	<i>Psoralea corylifolia</i>	Virus	SARS-CoV	1-150 µM	PLpro protease inhibition	Virus replication	18.3 µM	Kim et al., 2014	
Neobavaisoflavone	<i>Psoralea corylifolia</i>	Virus	SARS-CoV	1-150 µM	PLpro protease inhibition	Virus replication	18.3 µM	Kim et al., 2014	
Eckol	<i>Ecklonia cava</i>	Virus	Porcine epidemic diarrhea CoV	1-200 µM	Blockage of the binding of virus to cells	Virus entry	22.5 µM	Kwon et al., 2013	
Saikosaponins C	<i>Bupleurum Radix</i>	Virus	HCoV-229E	5-25 µM/mL	Undefined	Undefined	19.9 µM/mL	Chena et al., 2006	

26	Neobavaisoflavone	Psoralea corylifolia	Virus	SARS-CoV	1– 150 µM	PLpro protease inhibition	Virus replication	18.3 µM	Kim et al., 2014
27	Eckol	Ecklonia cava	Virus	Porcine epidemic diarrhea CoV	1–200 µM	Blockage of the binding of virus to cells	Virus entry	22.5 µM	Kwon et al., 2013
28	Salicosaponins C	Bupleurii Radix	Virus	HCoV-229E	5– 25 µM	Undefined	Undefined	19.9 µM	Cheng et al., 2005
29	Juglone	Polygonum aviculare	Virus	SARS-CoV	10– 40 µM	Blocks the 3a channel	Virus replication	2.3 µM	Schwarz et al., 2014
30	Emodin	Cassia occidentalis	Virus	SARS-CoV	0– 400 µM	Inhibited interaction of SARS-CoV (S) p	Virus replication	200 µM	Ho et al., 2007
31	Luteolin	Reseda luteola	Virus	SARS-CoV	1– 1,000 µM	3CL protease inhibition	Virus replication	20.2 µM	Ryu et al., 2010
32	Luteolin	Reseda luteola	Virus	SARS-CoV	0– 10–3 mol/L	Blocking the viral entry	Virus entry	10.6 µM	Yi et al., 2004
33	Luteolin	Reseda luteola	Virus	HIV-1/SARS pseudo type virus	0– 10–3 mol/L	Blocking the viral entry	Virus entry	9.02 µM	Yi et al., 2004
34	Procyanidin A2	Cinnamomi cortex	Virus	SARS-CoV	0– 500 µM	Inhibition of pseudovirus infection	Virus entry	29.9 µM	Zhuang et al., 2009
35	Singrin	Isatis indigotica	Virus	SARS-CoV	1– 100 µg/mL	3CL protease inhibition	Virus replication	217 µM	Lin et al., 2005
36	Procyanidin B1	Cinnamomi cortex	Virus	SARS-CoV	0– 500 µM	Inhibition of pseudovirus infection	Virus entry	41.3 µM	Zhuang et al., 2009
37	Quercetin	Torreya nucifera	Virus	SARS-CoV	1– 1,000 µM	3CL protease inhibition	Virus replication	23.8 µM	Ryu et al., 2010
38	Savinin	Phorocarpus sentalinus	Virus	SARS-CoV	8– 80 µM	3CL protease inhibition	Virus replication	25 µM	Wen et al., 2007
39	Apigenin	Torreya nucifera	Virus	SARS-CoV	1– 1,000 µM	3CL protease inhibition	Virus replication	280.8 µM	Ryu et al., 2010
40	Rhein	Rheum rhabarbarum	Virus	SARS-CoV	0– 400 µM	Inhibited interaction of SARS-CoV (S) p	Virus entry	200 µM	Ho et al., 2007
41	Tannic acid	Camellia sinensis	Virus	SARS-CoV	4– 20 µM	3CL protease inhibition	Virus replication	3 µM	Chen et al., 2005
42	Papryflavonol A	Broussonetia papyrifera	Target	3-chymotrypsin-like and papain-like	0– 200 µM	Protease inhibition	Virus replication	3.7 µM	Park et al., 2017
43	4-Hydroxyisolonchocarpin	Broussonetia papyrifera	Target	3-chymotrypsin-like and papain-like	0– 200 µM	Protease inhibition	Virus replication	30.2 to 233.3 µM	Park et al., 2017
44	Braussochalcone A	Broussonetia papyrifera	Target	3-chymotrypsin-like and papain-like	0– 200 µM	Protease inhibition	Virus replication	30.2 to 233.3 µM	Park et al., 2017
45	Braussochalcone B	Broussonetia papyrifera	Target	3-chymotrypsin-like and papain-like	0– 200 µM	Protease inhibition	Virus replication	30.2 to 233.3 µM	Park et al., 2017
46	Braussoflavan A	Broussonetia papyrifera	Target	3-chymotrypsin-like and papain-like	0– 200 µM	Protease inhibition	Virus replication	30.2 to 233.3 µM	Park et al., 2017
47	Kazinal A	Broussonetia papyrifera	Target	3-chymotrypsin-like and papain-like	0– 200 µM	Protease inhibition	Virus replication	30.2 to 233.3 µM	Park et al., 2017
48	Kazinal B	Broussonetia papyrifera	Target	3-chymotrypsin-like and papain-like	0– 200 µM	Protease inhibition	Virus replication	30.2 to 233.3 µM	Park et al., 2017
49	Kazinal F	Broussonetia papyrifera	Target	3-chymotrypsin-like and papain-like	0– 200 µM	Protease inhibition	Virus replication	30.2 to 233.3 µM	Park et al., 2017
50	Kazinal J	Broussonetia papyrifera	Target	3-chymotrypsin-like and papain-like	0– 200 µM	Protease inhibition	Virus replication	30.2 to 233.3 µM	Park et al., 2017
51	Cinanserin (1 opt)	Houttuynia cordata	Virus	Murine CoV	500– 15.63 µg/mL	Undefined	Undefined	31.25 µg/mL	Chow et al., 2016
52	Caryofol	Psoralea corylifolia	Virus	SARS-CoV	1– 150 µM	PLpro protease inhibition	Virus replication	32.3 µM	Kim et al., 2014
53	Rosmariquinone	Salvia miltiorrhiza	Virus	SARS-CoV	1– 1,000 µM	Inhibition of SARS-CoV viral infection a/	Virus entry	88.0 µM	Park et al., 2012
54	Hesperetin	Isatis indigotica	Virus	SARS-CoV	1– 100 µg/mL	3CL protease inhibition	Virus replication	365 µM	Lin et al., 2005
55	Bavachinin	Psoralea corylifolia	Virus	SARS-CoV	1– 150 µM	PLpro protease inhibition	Virus replication	38.4 µM	Kim et al., 2014
56	Psoralidin	Psoralea corylifolia	Virus	SARS-CoV	1– 150 µM	PLpro protease inhibition	Virus replication	4.2 µM	Kim et al., 2014
57	Salicosaponins B2	Bupleurii Radix	Virus	HCoV-229E	5– 25 µM	Inhibited viral attachment and penetratio	Virus entry	1.7 µM	Cheng et al., 2005
58	Curcumin	Curcuma longa	Virus	SARS-CoV	8– 80 µM	3CL protease inhibition	Virus replication	40 µM	Wen et al., 2007
59	Nicesamide	Curcuma longa	Virus	SARS-CoV	8– 80 µM	3CL protease inhibition	Virus replication	40 µM	Wen et al., 2007
60	Tanshinone I	Salvia miltiorrhiza	Virus	SARS-CoV	1– 1,000 µM	Inhibition of SARS-CoV viral infection a/	Virus entry	0.7 µM	Park et al., 2012
61	Tomentin E	Paulownia tomentosa	Virus	SARS-CoV	0– 100 µM	PLpro protease inhibition	Virus replication	5.0 µM	Cho et al., 2013
62	Tomentin B	Paulownia tomentosa	Virus	SARS-CoV	0– 100 µM	PLpro protease inhibition	Virus replication	6.1 µM	Cho et al., 2013

**Table 2: List of viral entry inhibiting compounds in herbal extracts obtained by data classification through computational tools (Detail data given in the Annexure II)**

1	Compound Name	Tanshinone I	Salicosaponins B2	7-Florobidol	Dryein (5,7-dihydro Rhein (1,8-dihydro Emodin (1,8-dihydro Edol	Procyanidin A2	Cinnamtannin B1	Tetra-O-galloyl-bate-O	Procyanidin B1	Rosmariquinone	Luteolin			
2	Class	Alkylbenzenes	Saponins	Dioxins	Flavonoids	Anthraquinones	Anthraquinones	Dioxins	Catechin	psoraleoylchrysin	gallic acid ester	Catechin	Phenanthrenes	Flavonoids
3	Max Phase	Research	Research	Research	Research	Research	Research	Research	Research	Research	Research	Research	Phase II	Phase I
4	Molecular Formula	C18H12O3	C42H60O13	C24H16O12	C15H10O4	C15H8O6	C15H10O5	C18H12O9	C30H24O12	C42H60O18	C34H28O22	C30H20O12	C19H22O2	C15H10O6
5	Molecular Weight	276.29	780.98	496.4	254.24	284.22	270.24	372.29	576.51	864.77	788.57	578.53	282.38	286.24
6	Synonyms	Tanshinone I	-	-	NSC-407436	Rhein	Emodin	Eckol	Procyanidin A2 P	Cinnamtannin B1	-	Procyanidin B1	Miltone Rosmariquinone	Diglyflavone Flacron LU
7	Molecule Type	Small molecule	Small molecule	Small molecule	Small molecule	Small molecule	Small molecule	Small molecule	Small molecule	Small molecule	Small molecule	Small molecule	Small molecule	Small molecule
8	Antiviral Activity	Yes	Yes	Yes	Yes	Yes	Yes	Yes	Yes	Yes	Yes	Yes	Yes	Yes
9	Antibacterial Activity	Yes	No	No	Yes	Yes	Yes	Yes	Yes	Yes	Yes	Yes	Yes	Yes
10	Antifungal Activity	No	No	No	Yes	Yes	Yes	No	No	No	No	Yes	Yes	Yes
11	Plant Source	Salvia miltiorrhiza	Eupuerum Falcatum	Ecklonia bigelovii	Oryzium indicum	Rheum palmatum	Aloe vera	Ecklonia cava	Cinnamomum cassia	Cinnamomum cassia	Phyllanthus emblica	Cinnamomum cassia	Rosmarinus officinalis	Rosmarinus officinalis
12	Available in India:	No	Yes	No	Yes	No	Yes	No	Yes	Yes	Yes	No	Yes	Yes
13								Bark	Bark	Fruits	Bark	leave	leave	leave

**Table 3: List of natural anti-viral compounds (essential oils) found in selected plants obtained by data mining through computational tools (Detail data given in the Annexure III)**

1	Cinnamon	Eucalyptus	Tea Tree	Rosmary
2	(e)-2-hexenal	1,8-cineole	cis-sabinene hydrate	camphene
3	(e)-beta-farnesene	alpha-pinene	delta-cadinene	beta-ocimene
4	(e)-beta-ocimene	camphene	alpha-phellandrene	cis-verbenol
5	(e)-cinnamaldehyde	gamma-terpinene	trans-piperitol	eugenol
6	(e)-cinnamyl acetate	alpha-terpineol	viridiflorene	geranyl acetate
7	(e)-nerolidol	limonene	isoledene	limonene
8	(z)-beta-ocimene	globulol	valencene	myrtenyl acetate
9	(z)-cinnamaldehyde	alpha-terpinyl acetate	(+)-ledene	sabinene
10	(z)-cinnamyl acetate	isoborneol	alpha-muurolol	alpha-terpineol
11	(z)-methyl cinnamate	p-cymene	alpha-cubebene	1,8-cineole
12	1,8-cineole	aromadendrene	alpha-thujene	alpha-pinene
13	3-phenylpropanal	trans-pinocarveol	beta-cedrene	3-octanone
14	4-hydroxy-3,4-dihydrocalacorene	beta-pinene	globulol	camphor
15	4-hydroxy-3,4-dihydrocalacorene	beta-eudesmol	beta-caryophyllene	1,8-cineole + beta-phellandrene
16	alpha-cadinene	carveol	citronellyl butyrate	piperitone
17	alpha-cadinol	myrcene	p-cymenene	beta-caryophyllene
18	alpha-copaene	terpinolene	o-cymene	borneol
19	alpha-fenchol	gamma-eudesmol	viridiflorol	verbenone

**Table 4: Result of Molecular docking of viral entry inhibiting compounds from herbal extracts against S-protein of SARS-CoV-2 (Detail data given in the Annexure IV)**

1	Name	CID	Binding_er	SMILES
2	Eckol	145937	7.7	C1=C(C=C(C=C1O)OC2=C(C=C(C3=C2OC4=C(C=C(C=C4O3)O)O)O)O)O
3	Procyanidin A2	124025	7.4	C1[C@H]([C@H](OC2=C1C(=CC3=C2[C@@H]4[C@H]([C@H](O3)OC5=CC(=CC(=C45)O)O)C6=CC(=C(C=C6)O)O)O)C7=CC(=C(C=C7)O)O)O)O
4	Cinnamtannin I	475277	7.4	C1[C@H]([C@H](OC2=C1C(=CC(=C2[C@@H]3[C@H]([C@H](OC4=C3C(=CC5=C4[C@@H]6[C@H]([C@H](O5)OC7=CC(=CC(=C67)O)O)O)O)O)O)O)O)O)O
5	Procyanidin B1	11250133	6.8	C1[C@@H]([C@H](OC2=C1C(=CC(=C2[C@@H]3[C@H]([C@H](OC4=CC(=CC(=C34)O)O)C5=CC(=C(C=C5)O)O)O)O)O)O)O)O)O)O)O)O)O)O)O
6	Tanshinone I	114917	6.3	CC1=C2C=CC3=C(C2=CC=C1)C(=O)C(=O)C4=C3OC=C4C
7	Luteolin	5280445	6.3	C1=CC(=C(C=C1C2=CC(=O)C3=C(C=C(C=C3O2)O)O)O)O
8	Rhein	10168	6.1	C1=CC2=C(C(=C1)O)C(=O)C3=C(C2=O)C=C(C=C3O)C(=O)O
9	Chrysin	5281607	6	C1=CC=C(C=C1)C2=CC(=O)C3=C(C=C(C=C3O2)O)O
10	viridiflorene	10910653	6	C[C@H]1CC2=C(C[C@@H]3[C@H]([C@H]12)C3(C)C)C
11	Emodin	3220	5.9	CC1=CC2=C(C(=C1)O)C(=O)C3=C(C2=O)C=C(C=C3O)O
12	alpha-bulneser	94275	5.7	C[C@H]1CCC2=C(CC[C@H](C[C@@H]12)C(=C)C)C
13	Rosmariquinon	160142	5.7	CC(C)C1=CC2=C(C3=C(C=C2)C(CCC3)(C)C)C(=O)C1=O
14	beta-bisabolen	10104370	5.6	CC1=CC[C@H](CC1)C(=C)CCC=C(C)C
15	benzyl benzoat	2345	5.5	C1=CC=C(C=C1)COC(=O)C2=CC=CC=C2

**Table 5: List of active compounds (essential oils) found in selected plants obtained by data enrichment through computational tools (Detail data given in the Annexure V)**

1	COUNTA of Compound name							
2	Compound name	cinnamon	Eucalyptus	Lemon grass	Peppermint	Rosemary	Tea Tree	Grand Total
3	(+)-ledene						1	1
4	(e)-2-hexenal	1						1
5	(e)-anethole		2					2
6	(e)-beta-caryophyllene					1		1
7	(e)-beta-farnesene	1				1		2
8	(e)-beta-ionone				16			16
9	(e)-beta-ocimene	2	1				5	8
10	(e)-cinnamaldehyde	1						1
11	(e)-cinnamyl acetate	1						1
12	(e)-nerolidol	1						1
13	(z)-beta-ocimene	2	4					6
14	(z)-cinnamaldehyde	1						1
15	(z)-cinnamyl acetate	2						2
16	(z)-methyl cinnamate	1						1
17	1-octen-3-ol				16			16
18	1,8-cineol						1	1
19	1,8-cineole	1	10		16	12	8	47

Finally, based on the reported data obtained from computational analysis and molecular docking, the formulation was made from the whole extract of *Cinnamomum zeylanicum* and essential oils of *Eucalyptus globulus*, *Melaleuca alternifolia* and *Rosamarinus officianalis* with addition of CuO and ZnO nanomaterials having anti-virulent activity. The formulation was coated on to the cellulose filter paper by spray coating method and subsequent drying the same at room temperature.



**Table 6: Result of Molecular docking of viral entry inhibiting compounds from essential oils against S-protein of SARS-CoV-2 (Detail data given in the Annexure VI)**

1	COUNTA of Compound name												
2	Compound name	CID	Smile	Binding energy	cinnamon	Eucalyptus	Lemon grass	Peppermint	Rosemary	Tea Tree	Grand Total		
3	viridiflorene	10910653	<chem>C[C@H]1CCC2=C(CC[C@H]1)C</chem>	6		2				7	9		
4	alpha-bulnesene	94275	<chem>C[C@H]1CCC2=C(CC[C@H]1)C</chem>	5.7		2					2		
5	beta-bisabolene	10104370	<chem>CC1=CC[C@H](CC1)C(=C)CC</chem>	5.6		1	1		1		3		
6	benzyl benzoate	2345	<chem>C1=CC=C(C=C1)COC(=O)C2=</chem>	5.5	1						1		
7	beta-copaene	57339298	<chem>CC(C)[C@H]1CC[C@]2([C@H]1)C</chem>	5.5					1		1		
8	selin-11-en-4-ol	6428380	<chem>CC(=C)C1CC[C@]2(CCC(C)C1)C</chem>	5.5	1						1		
9	valencene	9855795	<chem>C[C@H]1CCC=C2[C@]1(C)C</chem>	5.5						6	6		
10	beta-cadinene	10857	<chem>CC1=CC[C@H]2[C@H](C1)C</chem>	5.4						7	7		
11	beta-caryophyllene alcohol	61125	<chem>CC1(CC2C1CCC3(CCCC2(C3)O)C</chem>	5.4	1						1		
12	beta-cubebene	93081	<chem>C[C@H]1CC[C@H](C1)C</chem>	5.4						6	6		
13	beta-gurjunene	6450812	<chem>C[C@H]1CC[C@H]2[C@H]1C</chem>	5.4		2	1			7	10		
14	cubeban-11-ol	91704131	<chem>CC1CCC23C1C2C(CCC3C)C1</chem>	5.4						6	6		
15	ledol	92812	<chem>C[C@H]1CC[C@H]2[C@H]1C</chem>	5.4			1				1		
16	viridiflorol	11996452	<chem>C[C@H]1CC[C@H]2[C@H]1C</chem>	5.4					1	7	8		
17	(+)-ledene	10910653	<chem>C[C@H]1CCC2=C(CC[C@H]1)C</chem>	5.3						1	1		
18	alpha-cubebene	442359	<chem>C[C@H]1CC[C@H](C1)C</chem>	5.3						6	6		
19	beta-patchoulene	101731	<chem>CC1CCC2=C1CC3CCC2(C3)C</chem>	5.3						7	7		
20	gamma-eudesmol	6432005	<chem>CC1=C2C[C@H](CC[C@]2(C)C</chem>	5.3		2					2		
21	gamma-gurjunene	90805	<chem>CC1CCC(C=C2C1CCC2C)C(=C</chem>	5.3		2	1				3		
22	globulol	12304965	<chem>C[C@H]1CC[C@H]2[C@H]1C</chem>	5.3	1	7				8	16		
23	3-thujopsanone	13893399	<chem>C[C@H]1[C@H]2C[C@]23(C1)C</chem>	5.2						6	6		

**\*Total 233 compounds reported in selected plants with total of 1359 similar derivatives found in formulation.**



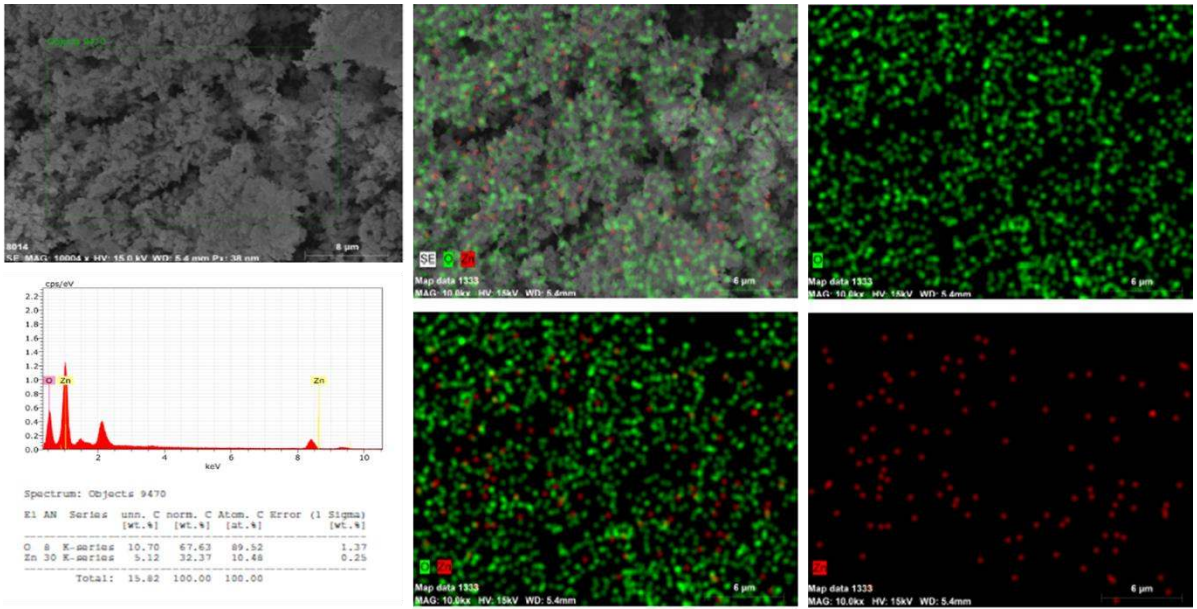

Figure 5: EDS of ZnO NPs

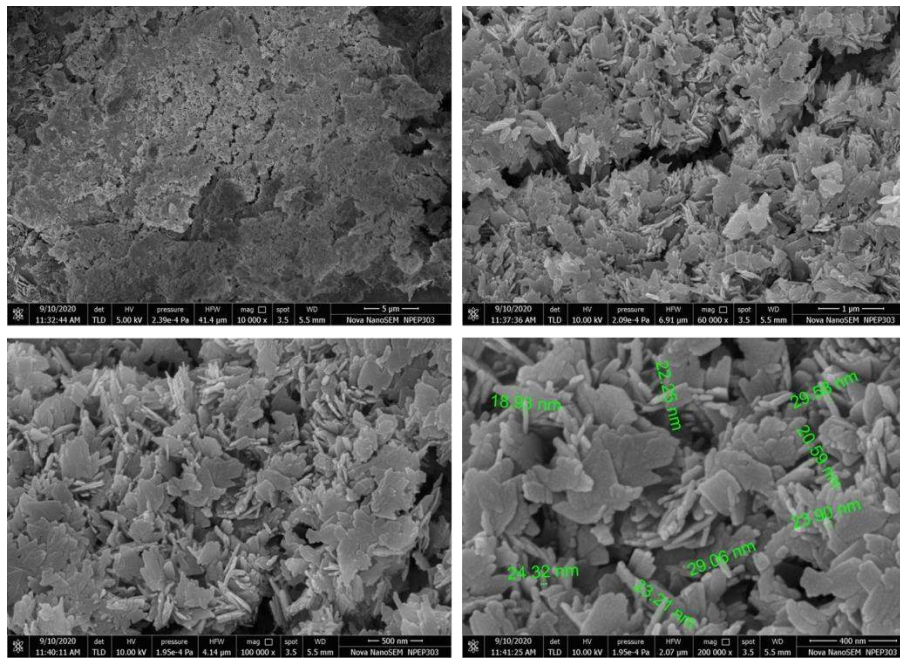

Figure 6: FESEM of CuO NPs



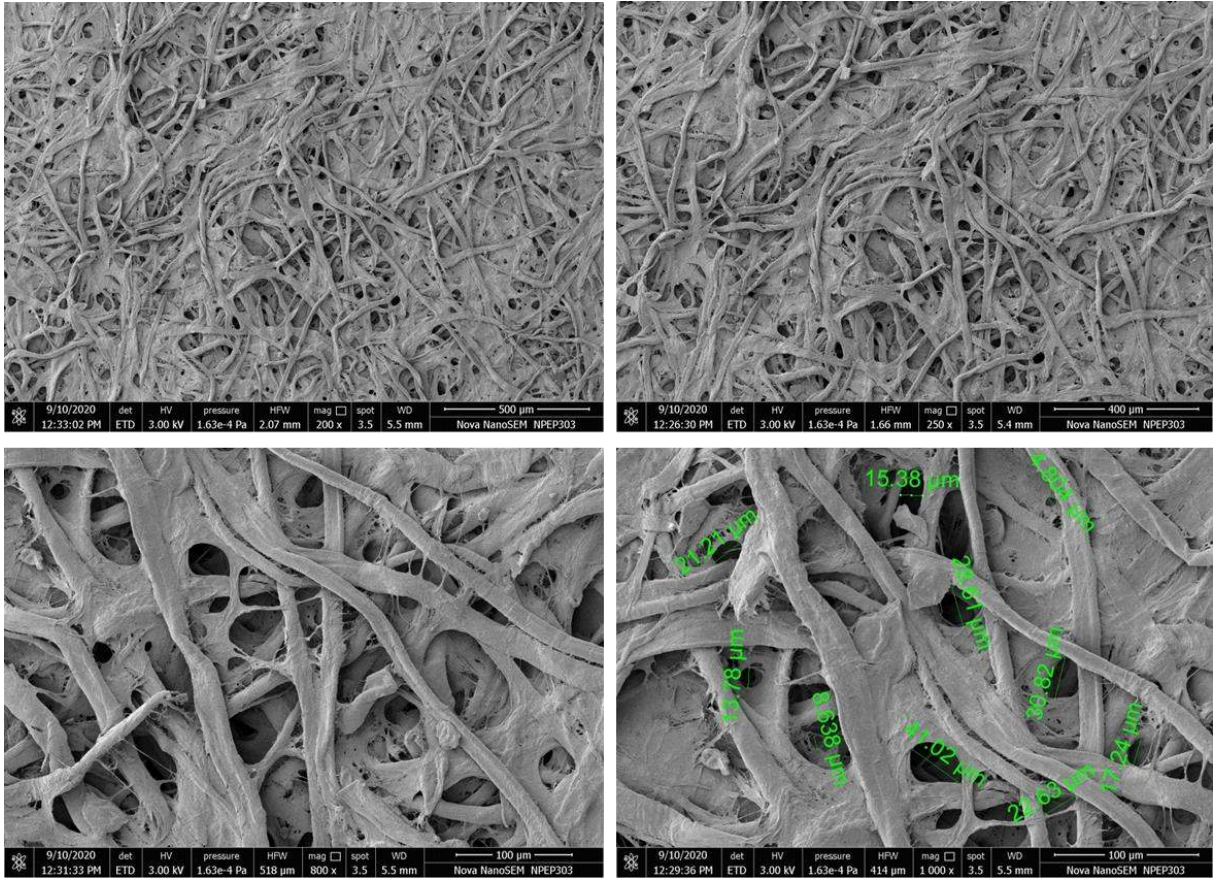

Figure 9: FESEM of Blank Cellulose Filter Paper

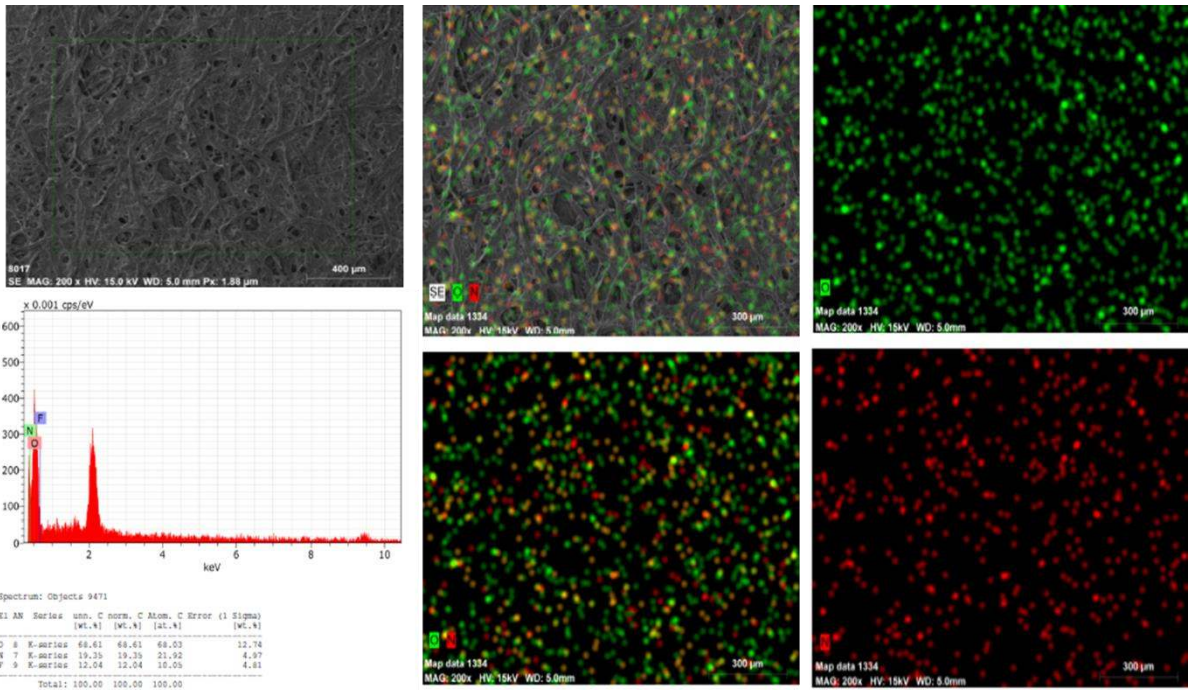
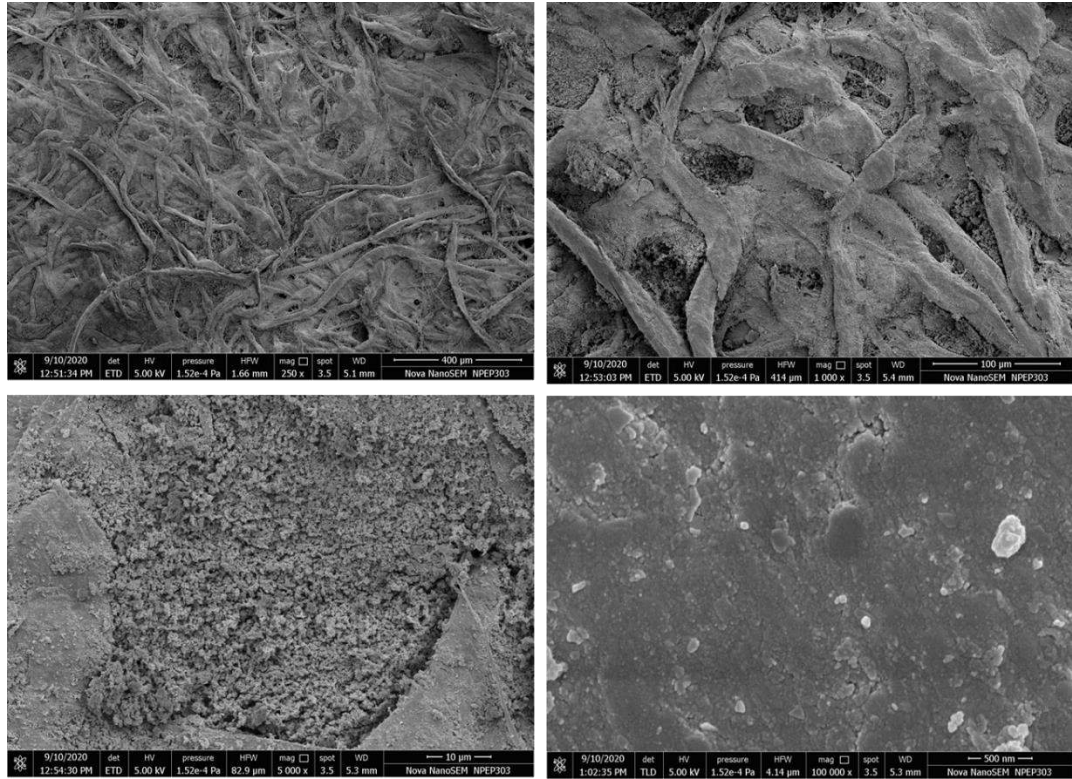
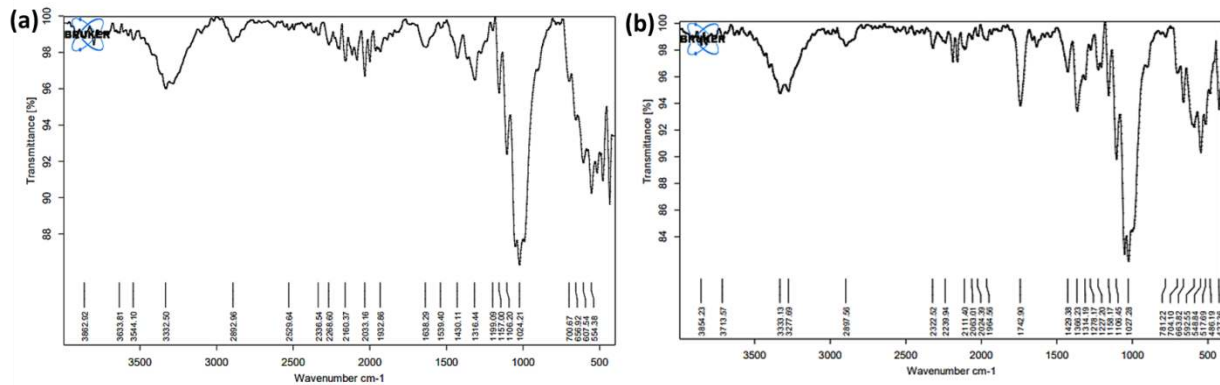

Figure 10: EDS of Blank Cellulose Filter Paper



**Figure 11: FESEM of Coated Cellulose Filter Paper**





**Figure 14: FT-IR Spectra of Blank and Coated Cellulose Filter Paper**

**iv. Fabric Testing and Certified by BTRA, Mumbai (Detail reports attached as Annexure VII)**

1. Weight (GSM) testing: 254.7 (KT 2A) and 220.2 (KT 2B), ASTM D:3776:2009:RA2017
2. Thickness (mm): 0.734 (KT 2A) and 0.655 (KT 2B), ASTM D:1777:1696:RA2015

**v. Testing and Validations (Initial prototype)\* (Detail reports attached as Annexure VII)**

**A. Chemical Test:**

3. Splash Resistance-ASTM F1862 at 160 mmHg – PASS (SITRA Certified)
4. Flammability-16 CFR Part-1610- 38.5, Class 1 material (SITRA Certified)
5. Water Vapour Transmission Rate- ASTM E 96-95: 3178.4 gm/m<sup>2</sup>/day (BTRA Certified)

**B. Biological Test:**

1. Bacterial filtration efficiency ASTM F 2101- 91.9%
2. Antimicrobial Testing AATCC 147- PASS (In-house testing, **Figure 15**)

**C. Physical Test:**

1. Breathability - Differential pressure-IS 16289: 2014- 32.03 Pa/cm<sup>2</sup> (SITRA Certified)
2. Particulate Filtration Efficiency at 0.3μ-A ASTM F2299/F2299M-03 : 2017 – 52.62 % (SITRA Certified)
3. Electrostatic Propensity (ISO 18080-1)- Excellent (BTRA Certified)

**\* As per the requirements of the application area the parameters and performance index of the K- BioMask can be changed and improved by upgrading the layers.**



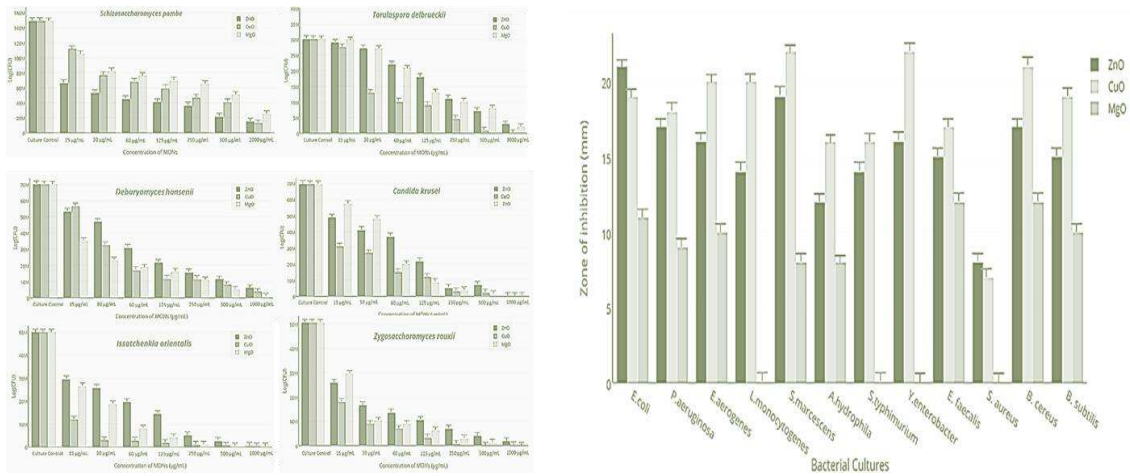

**Figure 3: Comparative analysis of antifungal and antibacterial activity of Nano formulations against fungal and bacterial cultures**

### vi. Uniqueness of the Technology

The proposed technology has unique feature as it will lead to development of functionalized active anti-virulent substrate (Layer of the mask) to improve the combat efficiency of ordinary mask against air borne infectious diseases. The active material layer is replaceable, which can be changed after 5 days of use. Additionally, electrostatic property of chiffon/silk cloth in layer 2 effectively removes charged particles (organic and inorganic) including viral capsid.

**vii. Technical Comparison with Commercial Medical Masks**

<b>Performance Index of Mask</b>	<b>Commercial Masks</b>	<b>K-BioMask</b>
Bacterial filtration efficiency ASTM F 2101*	> 95 %	> 91 % (without anti-virulent filter) <sup>#</sup>
Breathability - Differential pressure- (Pa/cm <sup>2</sup> ) IS 16289: 2014*	29.4 – 49.0	32.03
Flame resistance 16CFR Pat 1610***	Class 1 Class 2 Class 3	Class 1
PFE (%)**	30	52.62
Splash Resistance- ASTM F1862 at (mmHg)***	80-160	160
Antimicrobial Testing AATCC 147	NA	Pass
Reusability (days)	1 to 4	> 90 <sup>##</sup>
WVTR ASTM E 96-95	NA	3178.4 gm/m <sup>2</sup> /day (Comfortable for whole day use)
Fabric Material	Non-woven (Spun bonded PP)	Woven fabric material (Cotton, Chiffon/Silk, Polyester)

\*EU Standard: EN 14683 – 2014; \*\*(YY 0469 – 2004 medical surgical mask), \*\*\*US Standard: ASTM F2100-2004; <sup>#</sup> BFE can increase after inserting the filter paper into the mask as it has 0.11 micron pore size with antimicrobial activity due to nano-herbal coating. <sup>##</sup> Only filter papers has replace after every 5 days

**viii.**

**Mask Advantages**

- Simple design with refillable anti-viral filter paper
- Affordable
- Reliable
- Customized formulation can be used
- Common man can prepare and use it
- Recommended for use in public places, hospitals, social gatherings, travel, sanitation workers, suspected case patients, etc.
- Prevent inward or outward transmission of aerosols containing bacteria and viruses

The present innovation is indigenous and having unique specifications customized for the development of low cost anti-virulent mask for prevention of infectious diseases like COVID-19.